

# K15

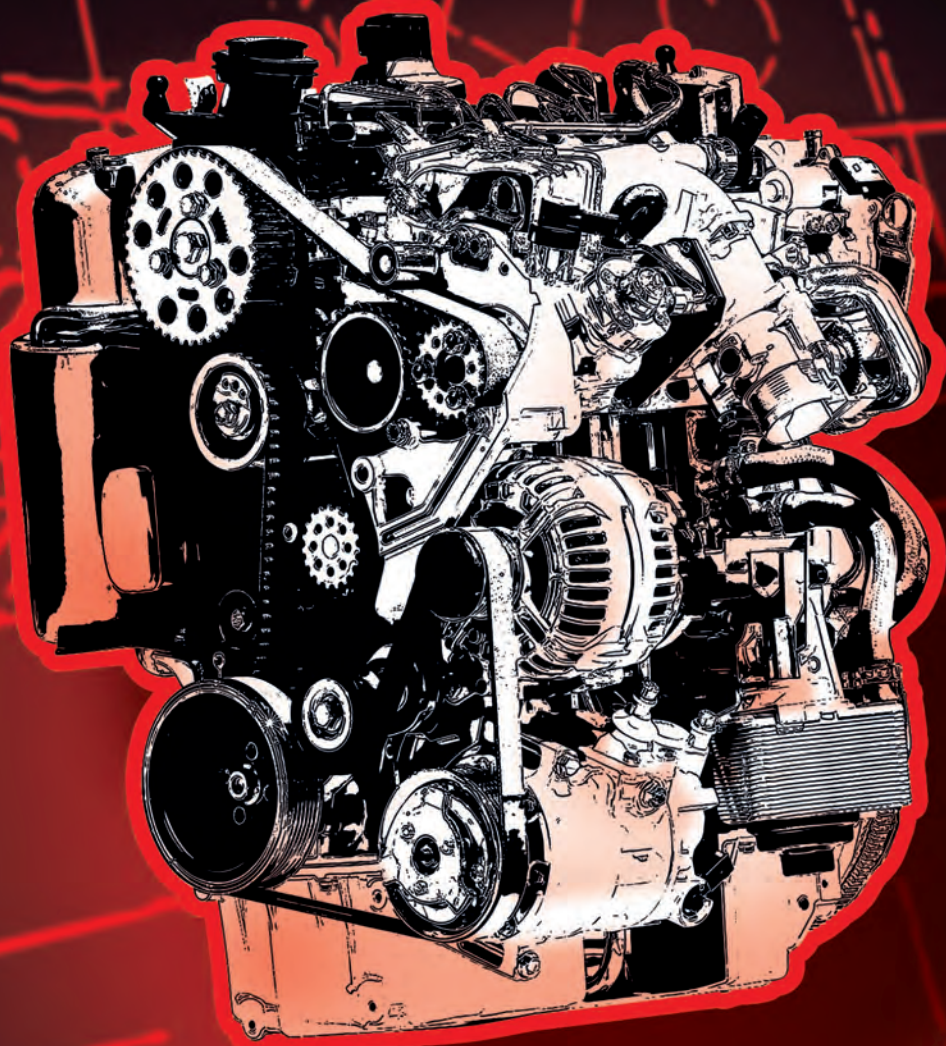

**KS TOOLS**



ENGINE TIMING TOOLS

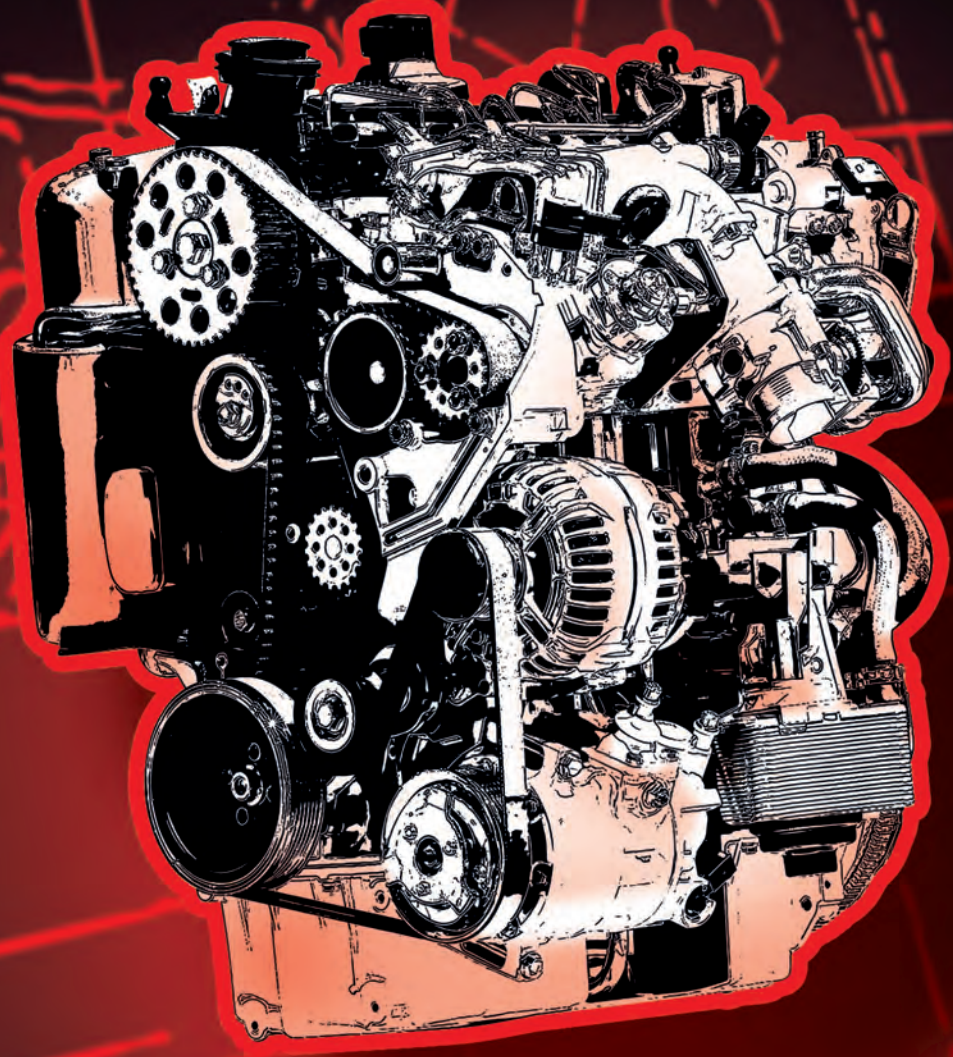

Innovation is our mission!



	PAGE
ALFA ROMEO	291 - 293
AUDI	293 - 302
BMW	303 - 307
CHRYSLER	307
CITROËN	308 - 310
FIAT	311 - 315
FORD	316 - 320
GM	320 - 321
HONDA	321
HYUNDAI	321
ISUZU	321 - 322
IVECO	322 - 323
JAGUAR	323 - 324
KIA	324
LANCIA	324 - 325
LAND ROVER	325 - 327
MAZDA	327 - 328
MERCEDES	328
MINI	328 - 329
MITSUBISHI	329
NISSAN	330 - 331
OPEL	331 - 336
PEUGEOT	336 - 339
PSA	339 - 342
RENAULT	343 - 346
ROVER	346 - 347
SAAB	347 - 349
SEAT & ŠKODA	350 - 354
VOLKSWAGEN	355 - 363
VOLVO	364 - 365
UNIVERSAL	365 - 369
BELT TENSION CHECKER	369

# THE RIGHT SPECIAL TOOL FOR EVERY USE!

With our special tool database, which is based upon information from Autodata®, we can help you find the right engine adjustment tools for your work:

- directly from the OE number
- from the vehicle selection
- from the engine code.

AFTERMARKET



Wir möchten dabei helfen, die richtigen Motoreinstellwerkzeuge für Ihre Arbeiten zu finden.  
Wählen sie unten die entsprechenden Daten zu ihrem Modell und sie bekommen eine Liste von Werkzeugen, die wir für sie anbieten.

Hersteller: Audi  
Modell: A5 Coupe/Cabriolet  
Baujahr: 2010  
Hubraum: 2.7  
Motorkennung: CAMA

Sie kennen den Motorcode oder die OEM-Nummer?  
Suchen sie hier und sie finden eine Liste der angebotenen Werkzeuge.  
OEM:  
Motorkennung:

Suchen

KS Code	Beschreibung	OEM
400 0159	Anstellband für Kurbelwelle	3359
400 9918	Fliehkraft für E-Pumpenrad VAG	T40061
400 1156	Justierwerkzeug für Nockenstellenstellung	T40060
400 1155	Nockenstellen-Fliehkraft-Satz, 2-3lg	T40062
400 1157	Kettenrad-Spanner	T40058
400 5043	Motor-Durchstellvorrichtung VAG 6+8Zyl, 2.4+3.2 FS	T40049
400 1153	Kurbelwellen-Drehvorrichtung Typ 2	

OE



**YOUR REQUIREMENTS,  
OUR SOLUTIONS!**

AUDI | BMW | CHRYSLER | CITROËN | FIAT | FORD | GM | HONDA | LEXUS | MAZDA |  
MERCEDES | MITSUBISHI | MORRIS | NISSAN | OPEL | PEUGEOT | RENAULT | TOYOTA |  
TRIUMPH | VOLKSWAGEN AUDI GROUP | VOLVO

[www.motoreinstellwerkzeuge.de](http://www.motoreinstellwerkzeuge.de)

[www.timingtools.de](http://www.timingtools.de)



kstools.com



Innovation is  
our mission!

ALFA ROMEO

Alfa Romeo / Fiat / Lancia - Engine Timing Tool Set

- For the professional engine repair
- For locking the crank shaft and cam shaft
- Suitable for pre-tensioning timing belt tensioner on the automatic pulley
- For changing the timing belt
- Very high degree of accuracy
- In durable steel storage case

**Application range:** universal usage on many Italian vehicles, in particular **Alfa Romeo, Fiat, Lancia** vehicles with 1.4 / 1.6 / 1.8 / 2.0 / Twinspark 1.2 / 1.4 / 1.6 / 1.8 16 V petrol engines 1.6 / 1.8 / 1.9D / TD / 2.0 / 2.1 12V / 2.4 diesel engines

Please carry out an up-to-date cross reference test for the specific vehicle on [www.timingtools.de](http://www.timingtools.de)

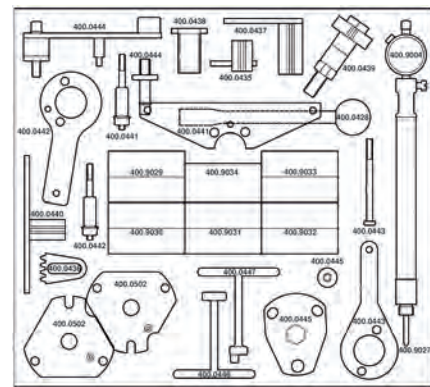
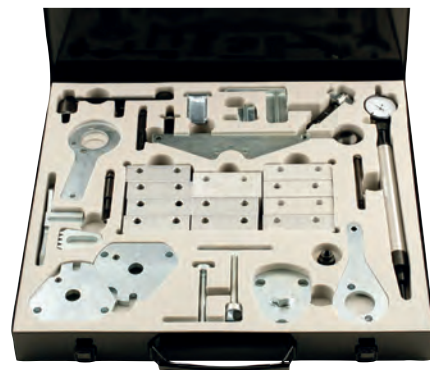

			kg
400.0425	34 pcs	Alfa Romeo / Fiat / Lancia - Engine Timing Tool Set	7.57

consists of:

			kg
400.0428	Tensioning tool - pry	170	
400.0435	Flywheel locking tool	57	
400.0436	Flywheel locking tool	135	
400.0437	Flywheel locking tool	100	
400.0438	Flywheel locking tool	51	
400.0439	Flywheel locking tool	317	
400.0440	Flywheel locking tool	136	
400.0441	Crankshaft timing tool (2)	154	
400.0442	Crankshaft timing tool (2)	154	
400.0443	Crankshaft timing tool (3)	160	
400.0444	Tensioning tool	240	
400.0445	Camshaft locking tool (2)	530	
400.0446	Balancer shaft belt tensioning tool	97	
400.0447	Tensioning tool - pry	70	
400.0502	Camshaft locking tool (2)	400	
400.9004	Precision-dial indicator gauge 0 - 10 mm	78	
400.9027	TDC determining pin Ø 5.0 mm / dial indicator bracket M14 x 1.25	288	
400.9029	Camshaft locking tool (2)	276	

consists of:

			kg
400.9030	Camshaft locking tool (2)	251	
400.9031	Camshaft locking tool (2)	272	
400.9032	Camshaft locking tool (2)	269	
400.9033	Camshaft locking tool (2)	276	
400.9034	Crankshaft timing tool	178	

Alfa Romeo / Fiat / Lancia camshaft alignment tools

- For the professional engine repair
- For locking the cam shaft wheels (TDC position)
- Secure hold thanks to optimal positioning
- Very high degree of accuracy

Please carry out an up-to-date cross reference test for the specific vehicle on [www.timingtools.de](http://www.timingtools.de)

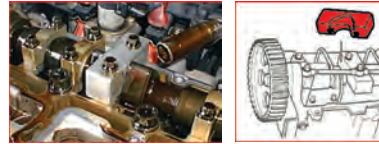

			Suitable for		kg
400.9028	4	156 2.5 V6 (> 1997)	690		
400.9029	2	145/146 1.8, 2.0 Twin Spark (> 1996), Spider/GTV 2.0 16v (> 1995)	276		
400.9030	2	145/146 1.4, 1.6 Twin Spark (> 1996), 155/156 Twin Spark (> 1996)	251		
400.9037	2	147 1.6 (105bhp) (>2004)	267		
400.9038	2	147 1.6 (120bhp) (>2004)	270		
400.9039	2	156 2.0 JTS (>2006)	267		

Alfa Romeo / Fiat / GM / Opel - Engine Timing Tool Set

- For the professional engine repair
- For changing the timing belt
- Very high degree of accuracy

**Application range:** Chevrolet Cruze, Orlando with 1.4 / 1.6 / 1.8 engines, Opel Astra-G, Astra-H, Corsa-D, Insignia, Meriva, Signum, Vectra-C, Zafira-B, Fiat Croma, Alfa Romeo 159 (engine code: Z / A / 939A4.000)

Please carry out an up-to-date cross reference test for the specific vehicle on [www.timingtools.de](http://www.timingtools.de)

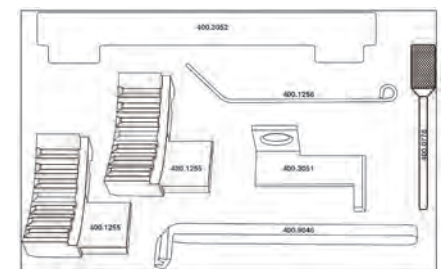
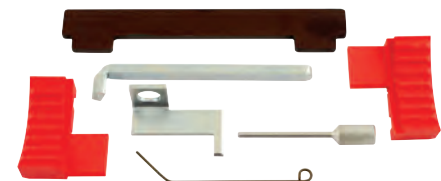
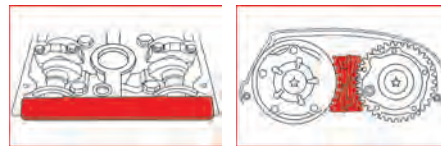

			kg
400.3050	7 pcs	Alfa Romeo / Fiat / GM / Opel - Engine Timing Tool Set	424

consists of:

			kg
400.0778	Locking pin	20	
400.1255	Camshaft locking tool (2)	56	
400.1256	Tensioner locking pin	3	
400.3051	Flywheel holding tool	32	
400.3052	Camshaft Locking Bar	148	
400.9046	Flywheel locking tool	80	

Alfa Romeo / Fiat / Lancia - Engine Timing Tool Set

- For the professional engine repair
- Especially for chain-driven engines
- Very high degree of accuracy
- In durable steel storage case

**Application range:** Fiat Panda, Punto, 500, 500c, Alfa Romeo Mito, Lancia Ypsilon (engine code: 313A2.000)

Please carry out an up-to-date cross reference test for the specific vehicle on [www.timingtools.de](http://www.timingtools.de)

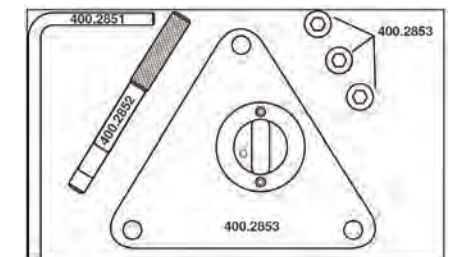

			kg
400.2850	6 pcs	Alfa Romeo / Fiat / Lancia - Engine Timing Tool Set	1.60

consists of:

			kg
400.2851	Flywheel locking tool	460	
400.2852	Pulley locking pin	550	
400.2853	Camshaft Locking Plate with screws	490	

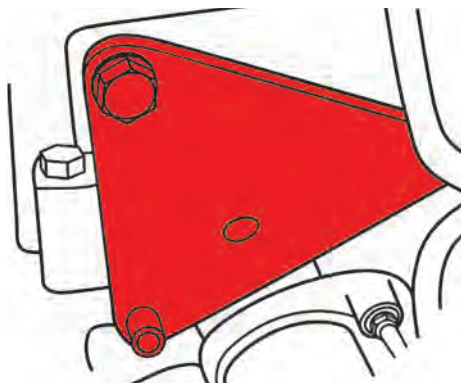



**Alfa Romeo / Fiat / Lancia - Engine Timing Tool Set**

- For the professional engine repair
- For locking the crank shaft
- For changing the timing belt
- Very high degree of accuracy
- In durable steel storage case

**Application range:** Alfa Romeo Mito, Giulietta MultiAir 105, MultiAir Turbo 135, 163 / 170 (2009-2013) Fiat Punto Evo, Punto, Bravo (2009-2013) Lancia Delta (2010-2013) - (engine code: 955A6.000 / 955A7.000 / 955A8.000 / 955A2.000 / 940A2.000)

Please carry out an up-to-date cross reference test for the specific vehicle on [www.timingtools.de](http://www.timingtools.de)

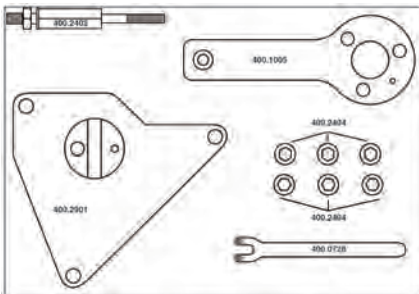
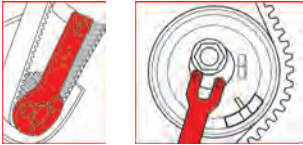

400.2900	10 pcs	Alfa Romeo / Fiat / Lancia - Engine Timing Tool Set	1.40
----------	--------	---	------

consists of:

400.0728	Tensioner adjusting tool	30
400.1005	Crankshaft locking tool	7
400.2403	Stud assembly	33
400.2404	Socket head screw M8 x 20 mm	13
400.2901	Tensioner adjusting tool	504

**Alfa Romeo / Fiat - Engine Timing Tool Set**

- For the professional engine repair
- For locking the crank shaft or cam shaft and injection pump
- Very high degree of accuracy
- In durable steel storage case

**Application range:** Fiat vehicles with 1.6 / 1.9 / 2.4 JTD Multi-jet diesel engines, Alfa Romeo with 2.0 JTD diesel engines (engine code: 939B3.000)

Please carry out an up-to-date cross reference test for the specific vehicle on [www.timingtools.de](http://www.timingtools.de)

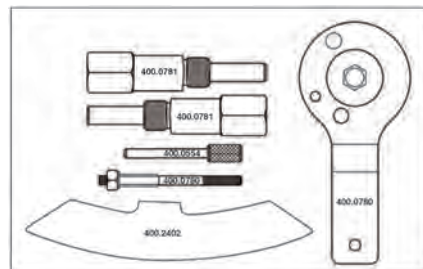

400.2400	7 pcs	Alfa Romeo / Fiat - Engine Timing Tool Set	1.46
----------	-------	--	------

consists of:

400.0554	Locking pin Ø 6.0 mm	19
400.0780	Crankshaft pulley setting tool (3)	260
400.0781	Camshaft timing pin set (2)	180
400.2402	Flywheel sprocket alignment tool	130

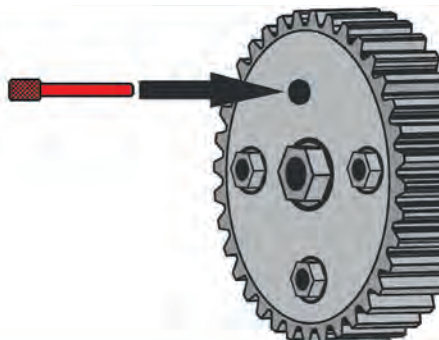

**Alfa Romeo / Fiat - Engine Timing Tool Set**

- For the professional engine repair
- For locking the cam shaft
- Very high degree of accuracy
- In durable steel storage case

**Application range:** Alfa Romeo Giulietta, Mito, Fiat 500, Brava, Bravo, Grande Punto, Marea, Marea Weekend, Marengo, Palio Weekend, Panda, Punto Classic, Ritmo, Stilo, Idea, Lancia Delta, Susa, Ypsilon with 1.2 16V engines

Please carry out an up-to-date cross reference test for the specific vehicle on [www.timingtools.de](http://www.timingtools.de)

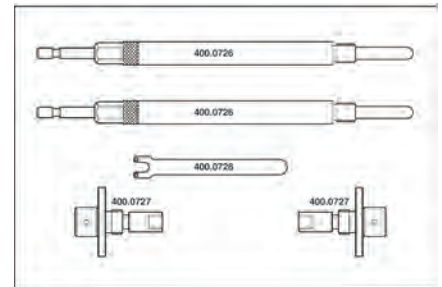

400.0725	5 pcs	Alfa Romeo / Fiat - Engine Timing Tool Set	989
----------	-------	--	-----

consists of:

400.0726	Piston height gauge (2)	250
400.0727	Camshaft locking tool (2)	130
400.0728	Tensioner adjusting tool	30

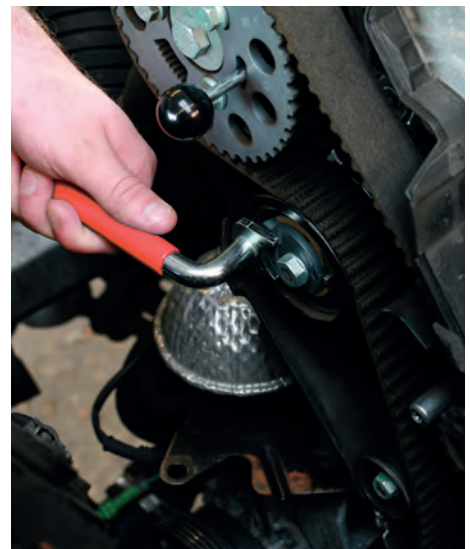

**Alfa Romeo / Fiat / Lancia - Engine Timing Tool Set**

- For the professional engine repair
- For changing the timing belt
- Very high degree of accuracy
- In durable steel storage case

**Application range:** Alfa Romeo Giulietta , MiTo Fiat 500, Bra-va, Bravo, Grande Punto, Marea, Marea Weekend, Marengo, Palio Weekend Panda, Punto, Punto Classic, Ritmo, Stilo, Idea  
**Lancia** Delta, Musa, Ypsilon

Please carry out an up-to-date cross reference test for the specific vehicle on [www.timingtools.de](http://www.timingtools.de)

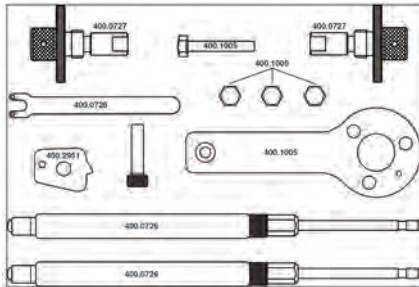

				🔑
400.2950	12 pcs	Alfa Romeo / Fiat / Lancia - Engine Timing Tool Set	1.22	

consists of:

				🔑
X				
400.0726	1	Piston height gauge (2)	250	
400.0727	1	Camshaft locking tool (2)	130	
400.0728	1	Tensioner adjusting tool	30	
400.1005	5	Crankshaft locking tool	7	
400.2951	1	Camshaft pulley holding tool(2)	126	

**Alfa Romeo phase adjuster**

- For the professional engine repair
- For the safe removal of the cam shaft phase adjuster (variator)
- Special steel
- Very high degree of accuracy

**Application range:** Alfa Romeo 145/145 Twin Spark with 1.4 engines with cam shaft variator

Please carry out an up-to-date cross reference test for the specific vehicle on [www.timingtools.de](http://www.timingtools.de)



				🔑
Suitable for	D mm	d mm		
400.9005	Alfa Romeo	57.0	24.0	283

**Alfa Romeo automatic tension pulley wrench**

- Eccentric
- Suitable for the assembly and disassembly of the timing belt
- For adjusting the timing belt tension on the automatic pulley
- Not suitable for balancing belts
- With t-handle
- With plastic-coated handle
- Chrome vanadium

**Application range:** Alfa Romeo 145, 146 for 1.4L and 1.6L Twin Spark engines >1996, Alfa Romeo 155, 156 for 1.6L Twin Spark engines >1996



				🔑
Suitable for		Length mm		
150.1253	Alfa Romeo	83.0	80	

**AUDI**

**VAG - Engine Timing Tool Set**

- For the professional engine repair
- For locking the crank shaft or cam shaft
- Very high degree of accuracy
- In durable steel storage case

**Application range:** Audi, Seat, Škoda, Volkswagen with 1.4 / 1.6 / 1.8 / 2.0 Turbo / 2.2 / 2.3 / 1.8 / 2.0 16V, 2.6 / 2.8 with petrol engines and 1.0 / 1.2 / 1.3 / 1.4 / 1.9 TDi / 1.7 / 1.9 SDi / 2.5 TDi / 2.8 30V diesel engines

Please carry out an up-to-date cross reference test for the specific vehicle on [www.timingtools.de](http://www.timingtools.de)

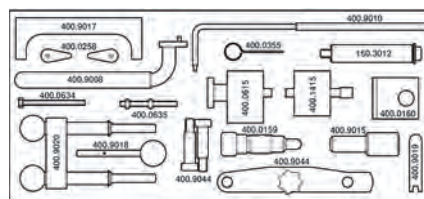
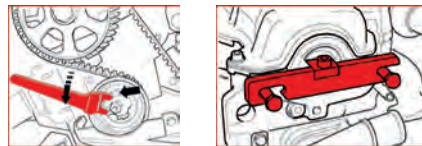

				🔑
400.2225	19 pcs	VAG - Engine Timing Tool Set	2.23	

consists of:

				🔑
400.0159		Crankshaft timing pin	120	

consists of:

			🔑
400.9044	Camshaft setting strap	309	
400.9020	Camshaft locking tool	340	
400.9019	Tensioner locking tool	20	
400.9018	Injection pump locking pin Ø 6.0 mm	20	
400.9017	Camshaft setting strap	120	
400.9015	Injection pump locking pin Ø 15.4 mm	126	
400.9010	Automatic pulley wrench for pin-type face	230	
400.9008	Automatic pulley wrench for pin-type face	206	
400.1415	Crankshaft pulley setting tool	192	
400.0635	Stud and nut M5 x 55.0 mm	8	
400.0634	Locking screw M5 x 55.0 mm	8	
400.0615	Crankshaft pulley setting tool	190	
400.0355	Tensioner pushrod retension pin	1	
400.0258	Shim tool (2)	3	
400.0160	Camshaft timing tool (2)	118	
150.3012	VAG front mask push back	170	

**VAG - Engine Timing Tool Set**

- For the professional engine repair
- For locking the cam shaft
- For changing the timing belt
- Very high degree of accuracy
- In durable steel storage case

**Application range:** Audi A2 with 1.2, 1.4 TDI engines, A3 with 1.9 TDI engines (> 1996), A3, A4, A6 with 1.9TDI engines (>1999), Seat Toledo with 1.9 TDI engines (>1999), Škoda Octavia with 1.9 SDI/TDI engines (>1996), Volkswagen Golf, Bora with 1.9 SDI/TDI engines, New Beetle with 1.9 TDI engines (>1997), Lupo with 3L 1.2 TDI, Lupo, Polo 1.4 TDI, Golf, Bora 1.9 TDI engines (>1999)

Please carry out an up-to-date cross reference test for the specific vehicle on [www.timingtools.de](http://www.timingtools.de)

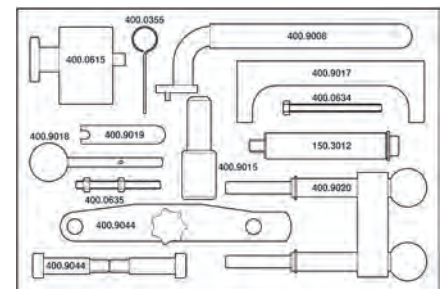
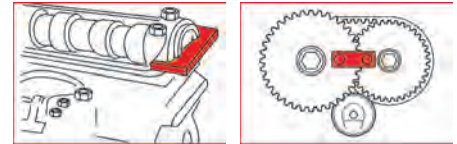

				🔑
400.0625	12 pcs	VAG - Engine Timing Tool Set	1.73	

consists of:

				🔑
400.0355		Tensioner pushrod retension pin	1	
400.9044		Camshaft setting strap	309	
400.9020		Camshaft locking tool	340	

consists of:

400.9019	Tensioner locking tool	20
400.9018	Injection pump locking pin Ø 6.0 mm	20
400.9017	Camshaft setting strap	120
400.9015	Injection pump locking pin Ø 15.4 mm	126
400.9008	Automatic pulley wrench for pin-type face	206
400.0635	Stud and nut M5 x 55,0 mm	8
400.0634	Locking screw M5 x 55,0 mm	8
400.0615	Crankshaft pulley setting tool	190
150.3012	VAG front mask push back	170

### VAG - Engine Timing Tool Set

- For the professional engine repair
- Comprehensive set for locking timing chains
- Very high degree of accuracy
- In durable steel storage case

**Application range:** Audi A3, A4, A6, A8, Škoda Octavia, Volkswagen Polo, Golf, Touran, Passat (engine code: AXW / AXU / BAG / BLF / BKG / BLN / BLP / BUL / BPJ / BGB / BWA / BWE)

Please carry out an up-to-date cross reference test for the specific vehicle on [www.timingtools.de](http://www.timingtools.de)

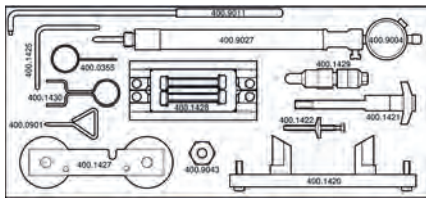
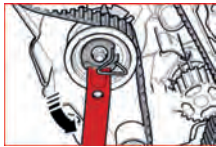
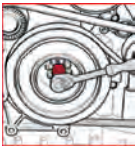

400.2300	17 pcs VAG - Engine Timing Tool Set	2.83

consists of:

400.0355	Tensioner pushrod retention pin	1
400.0901	Tensioning locking pin	4
400.1420	Camshaft alignment tool	802
400.1421	Chain tensioner retainer	40
400.1422	Chain tensioner retainer	17
400.1425	Tensioning locking pin	11
400.1427	Camshaft alignment tool	433
400.1428	Camshaft locking tool (4)	665
400.1429	Crankshaft timing pin	80
400.1430	Timing chain tensioner locking pin	10
400.9004	Precision-dial indicator gauge 0 - 10 mm	78
400.9011	Automatic pulley wrench for pin-type face	259
400.9027	TDC determining pin Ø 5,0 mm / dial indicator bracket M14 x 1,25	288
400.9043	VAG Crankshaft pulley bolt adaptor	140



### VAG - Engine Timing Tool Set

- For the professional engine repair
- For chain-driven vehicles
- Very high degree of accuracy
- In durable steel storage case

**Application range:** Audi A3, Volkswagen Polo, Golf, Jetta, Passat, Eos, Tiguan, Touran (engine code: AXU / BAG / BKG / BLF / BLN / BLP / BMY / BWK / CAXA)

Please carry out an up-to-date cross reference test for the specific vehicle on [www.timingtools.de](http://www.timingtools.de)

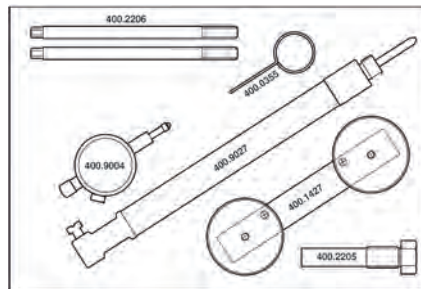
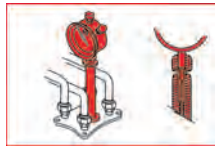

400.2200	7 pcs VAG - Engine Timing Tool Set	2.11

consists of:

400.1427	Camshaft alignment tool	433
400.9027	TDC determining pin Ø 5,0 mm / dial indicator bracket M14 x 1,25	288
400.9004	Precision-dial indicator gauge 0 - 10 mm	78
400.2206	Crankshaft locking pin (2)	53
400.2205	Crankshaft locking pin	111
400.0355	Tensioner pushrod retention pin	1

### VAG - Engine Timing Tool Set

- For the professional engine repair
- For changing the timing belt or the chain
- Very high degree of accuracy
- In durable steel storage case

**Application range:** Audi vehicles (2003-2010) with 2.0 FSI and TFSI engines

Please carry out an up-to-date cross reference test for the specific vehicle on [www.timingtools.de](http://www.timingtools.de)

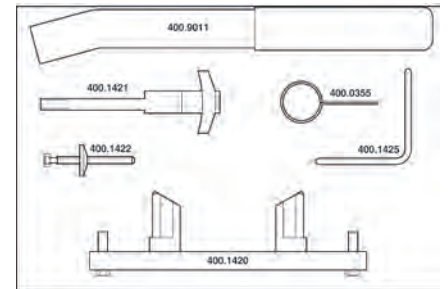
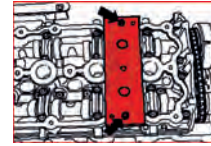

400.2175	6 pcs VAG - Engine Timing Tool Set	1.35

consists of:

400.0355	Tensioner pushrod retention pin	1
400.1420	Camshaft alignment tool	802
400.1421	Chain tensioner retainer	40
400.1422	Chain tensioner retainer	17
400.1425	Tensioning locking pin	11
400.9011	Automatic pulley wrench for pin-type face	259

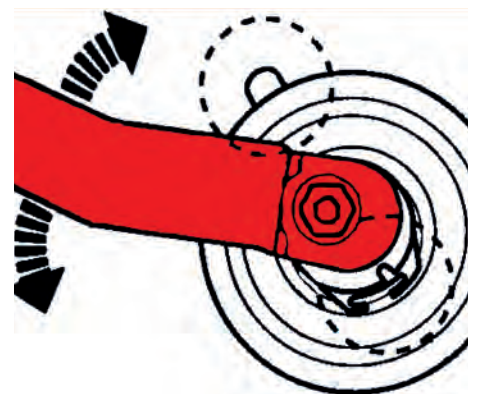



**VAG - Engine Timing Tool Set**

- For the professional engine repair
- For locking the crank shaft or cam shaft
- Very high degree of accuracy
- In durable steel storage case

**Application range:** Audi vehicles with V6, V8, V10 FSI engines

Please carry out an up-to-date cross reference test for the specific vehicle on [www.timingtools.de](http://www.timingtools.de)

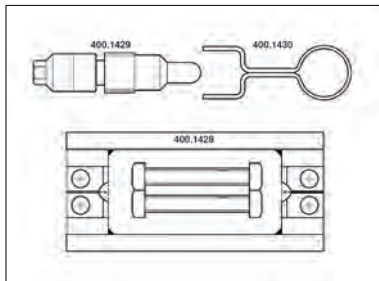

400.2250	6 pcs VAG - Engine Timing Tool Set	899

consists of:

400.1428	Camshaft locking tool (4)	665
400.1429	Crankshaft timing pin	80
400.1430	Timing chain tensioner locking pin	10

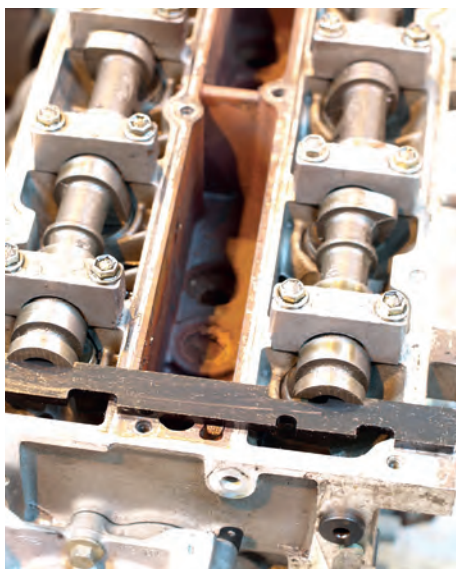

consists of:

400.9043	VAG Crankshaft pulley bolt adaptor	140

**VAG - Engine Timing Tool Set**

- For the professional engine repair
- Especially for timing wheel-driven vehicles
- For adjusting the injection adjuster via the cam shaft follower
- Very high degree of accuracy
- In durable steel storage case

**Application range:** Volkswagen Touareg, Transporter (> 2003) with 2.5 TDI engines (engine code: BAC / BLK / BPD / AXD / AXE / BLJ / BNZ / BPC) and 4.9D / TDI (engine code: AYH)

Please carry out an up-to-date cross reference test for the specific vehicle on [www.timingtools.de](http://www.timingtools.de)

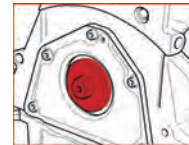

**VAG - Engine Timing Tool Set**

- For the professional engine repair
- For locking the cam shaft
- For changing the timing chain
- Very high degree of accuracy
- In durable steel storage case

**Application range:** Audi A4 (2005-2009) with 2.7 TDI engine, A4 Quattro (2005-2006) with 2.0 TDI engine, Q7 with 3.0 TDI engine, Volkswagen Touareg (>2008), Phaeton (>2006) with 3.0 TDi V6 engine (engine code: BPP / BMZ / BUG / BUN)

Please carry out an up-to-date cross reference test for the specific vehicle on [www.timingtools.de](http://www.timingtools.de)

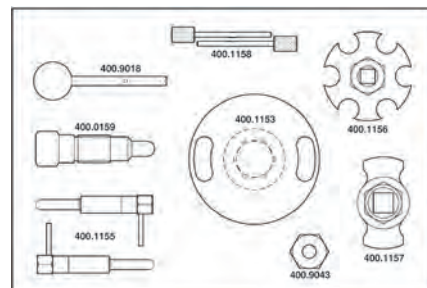
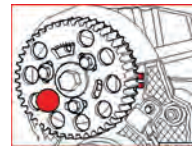

400.1150	10 pcs VAG - Engine Timing Tool Set	2.41

consists of:

400.0159	Crankshaft timing pin	120
400.1153	Crankshaft turning tool	354
400.1155	Camshaft locking pin (2)	47
400.1156	Camshaft alignment/locking tool	366
400.1157	Camshaft sprocket holding tool	120
400.1158	Timing pin Ø 3,3 mm (2)	12
400.9018	Injection pump locking pin Ø 6,0 mm	20

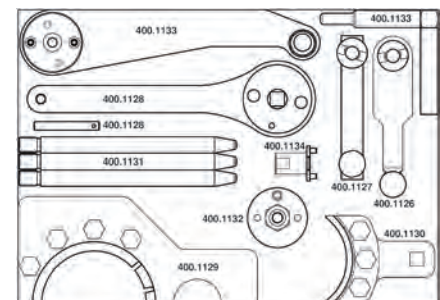

400.1125	12 pcs VAG - Engine Timing Tool Set	9.45

consists of:

400.1126	Camshaft locking tool	226
400.1127	Camshaft locking tool	174
400.1128	Crankshaft timing tool (2)	1194
400.1129	Camshaft gear retaining tool (big)	2769
400.1130	Camshaft gear retaining tool (small)	677

consists of:

400.1131	Guide pin set (3)	769
400.1132	Crankshaft turning tool (TDC-cylinder 1)	141
400.1133	Crankshaft alignment tool (TDC-cylinder 1)	998
400.1134	Camshaft compensation gear pre-tensioning tool	75

### VAG - Engine Timing Tool Set

- For the professional engine repair
- For changing the timing belt or the timing chain
- Very high degree of accuracy
- In durable steel storage case

**Application range:** Audi, Seat, Škoda, Volkswagen vehicles including FSI and TFSI engines

Please carry out an up-to-date cross reference test for the specific vehicle on [www.timingtools.de](http://www.timingtools.de)

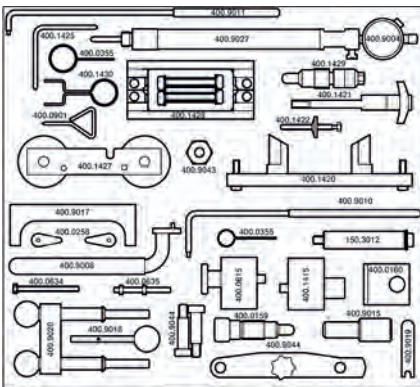
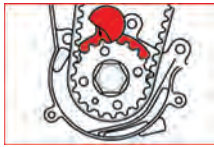
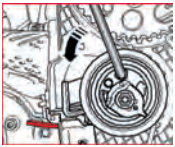

400.1400	35 pcs VAG - Engine Timing Tool Set	7.94

consists of:

400.0159	Crankshaft timing pin	120
400.9044	Camshaft setting strap	309
400.9043	VAG Crankshaft pulley bolt adaptor	140
400.9027	TDC determining pin Ø 5,0 mm / dial indicator bracket M14 x 1,25	288
400.9020	Camshaft locking tool	340

consists of:

400.9019	Tensioner locking tool	20
400.9018	Injection pump locking pin Ø 6.0 mm	20
400.9017	Camshaft setting strap	120
400.9015	Injection pump locking pin Ø 15.4 mm	126
400.9011	Automatic pulley wrench for pin-type face	259
400.9010	Automatic pulley wrench for pin-type face	230
400.9008	Automatic pulley wrench for pin-type face	206
400.9004	Precision-dial indicator gauge 0 - 10 mm	78
400.1430	Timing chain tensioner locking pin	10
400.1429	Crankshaft timing pin	80
400.1428	Camshaft locking tool (4)	665
400.1427	Camshaft alignment tool	433
400.1425	Tensioning locking pin	11
400.1422	Chain tensioner retainer	17
400.1421	Chain tensioner retainer	40
400.1420	Camshaft alignment tool	802
400.1415	Crankshaft pulley setting tool	192
400.0901	Tensioning locking pin	4
400.0635	Stud and nut M5 x 55,0 mm	8
400.0634	Locking screw M5 x 55,0 mm	8
400.0615	Crankshaft pulley setting tool	190
400.0355	Tensioner pushrod retensioning pin	1
400.0258	Shim tool (2)	3
400.0160	Camshaft timing tool (2)	118
150.3012	VAG front mask push back	170

### VAG - Engine Timing Tool Set

- For the professional engine repair
- For changing the timing belt or the chain
- Very high degree of accuracy
- In durable steel storage case

**Application range:** Audi A3, A4, A5, A6, Q5, Volkswagen Golf, Tiguan, Passat, Eos, Seat Exeo

Please carry out an up-to-date cross reference test for the specific vehicle on [www.timingtools.de](http://www.timingtools.de)

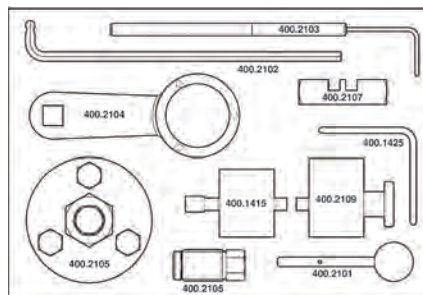
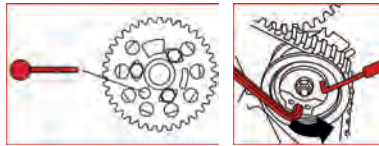

400.2100	9 pcs VAG - Engine Timing Tool Set	2.61

consists of:

400.1415	Crankshaft pulley setting tool	192
400.1425	Tensioning locking pin	11
400.2101	Injection pump/camshaft alignment pin	14
400.2102	Tensioner adjuster Ø 6.0 mm	20
400.2103	Tensioner adjuster Ø 2.5 mm	216
400.2104	Sprocket holding tool	179
400.2105	Cam sprocket hub puller	581
400.2107	Setting tool	72
400.2109	Crankshaft pulley locking tool (bored)	300

### VAG - Engine Timing Tool Set

- For the professional engine repair
- For timing wheel-driven engines
- Very high degree of accuracy
- In durable steel storage case

**Application range:** Volkswagen Touareg, Transporter (engine code: AXE / AXD / BAC / BLK / BLJ / BNZ / BPC / BPE / BPD)

Please carry out an up-to-date cross reference test for the specific vehicle on [www.timingtools.de](http://www.timingtools.de)

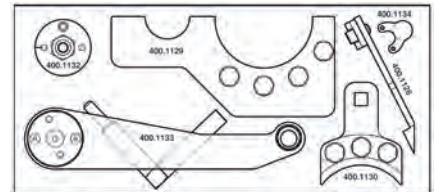
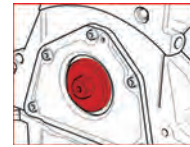

400.2500	6 pcs VAG - Engine Timing Tool Set	6.50

consists of:

400.1126	Camshaft locking tool	226
400.1129	Camshaft gear retaining tool (big)	2769
400.1130	Camshaft gear retaining tool (small)	677
400.1132	Crankshaft turning tool (TDC-cylinder 1)	141
400.1133	Crankshaft alignment tool (TDC-cylinder 1)	998
400.1134	Camshaft compensation gear pre-tensioning tool	75



**VAG - Engine Timing Tool Set**

- For the professional engine repair
- Especially for chain-driven engines
- Very high degree of accuracy
- In durable steel storage case

**Application range:** Audi A4, A6 (engine code: ASN / BBJ)

Please carry out an up-to-date cross reference test for the specific vehicle on [www.timingtools.de](http://www.timingtools.de)

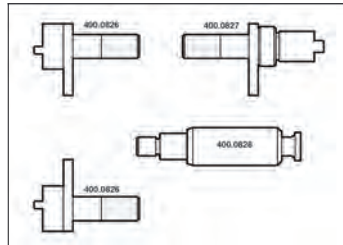
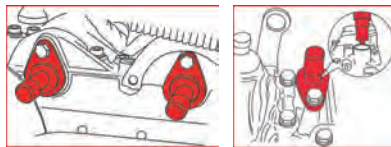
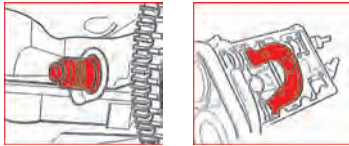

400.0825	4 pcs	VAG - Engine Timing Tool Set
		747

consists of:

400.0826	Camshaft aligning tool 12V (2)	97
400.0827	Camshaft aligning tool 6V	113
400.0828	Crankshaft locking pin 6V/12V	115

**VAG - Engine Timing Tool Set**

- For the professional engine repair
- For locking the cam shaft
- For changing the timing belt
- Very high degree of accuracy
- In durable steel storage case

**Application range:** Volkswagen and other VW Group vehicles 1.4 / 1.6 FSi and 1.4 TSi and 1.2 TFSi / FSi engines

Please carry out an up-to-date cross reference test for the specific vehicle on [www.timingtools.de](http://www.timingtools.de)

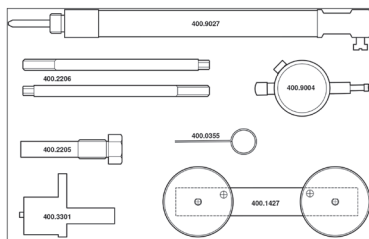
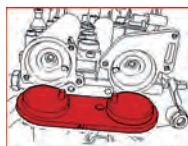

400.3300	8 pcs	VAG - Engine Timing Tool Set
		2.14

consists of:

400.0355	Tensioner pushrod retension pin	1
400.9027	TDC determining pin Ø 5,0 mm / dial indicator bracket M14 x 1.25	288
400.1427	Camshaft alignment tool	433
400.2205	Crankshaft locking pin	111
400.2206	Crankshaft locking pin (2)	53
400.3301	Camshaft locking tool	174
400.9004	Precision-dial indicator gauge 0 - 10 mm	78

**VAG - Engine Timing Tool Set**

- For the professional engine repair
- Expansion set for use alongside 400.2300 / 400.3300
- Very high degree of accuracy
- In durable steel storage case

**Application range:** Audi, Seat, Škoda, Volkswagen vehicles with 1.8 / 2.0 TFSI and FSI engines

Please carry out an up-to-date cross reference test for the specific vehicle on [www.timingtools.de](http://www.timingtools.de)

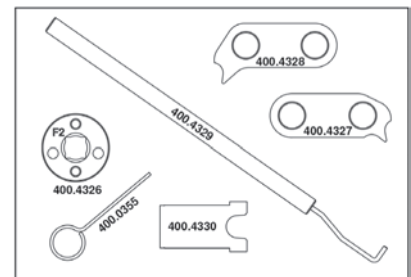
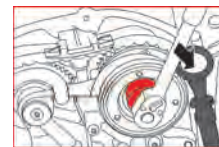

400.4325	7 pcs	VAG - Engine Timing Tool Set
		1.87

consists of:

400.0355	Tensioner pushrod retension pin	1
400.4326	Cam shaft control valve removal tool	60
400.4327	Cam shaft clamp external	130
400.4328	Cam shaft clamp internal	130
400.4329	Oil pumps securing pin	160
400.4330	Timing chain wrench	30

400.2275	5 pcs	VAG - Engine Timing Tool Set
		2.46

consists of:

400.0355	Tensioner pushrod retension pin	1
400.2276	Crankshaft locking tool	80
400.2277	Camshaft locking tool (2)	1050
400.2278	Camshaft sprocket adjusting tool	80

**VAG - Engine Timing Tool Set**

- For the professional engine repair
- For locking the cam shaft
- For changing the timing belt
- Very high degree of accuracy
- In durable steel storage case

**Application range:** Volkswagen Lupo, Polo with 1.2 6V / 12V engines, Seat Cordoba, Ibiza with 1.2 engines (2002-2009), Škoda Fabia II, Roomster with 1.2P engines (engine code: AWY / BMD / AZQ / BME / BZG)

Please carry out an up-to-date cross reference test for the specific vehicle on [www.timingtools.de](http://www.timingtools.de)

### VAG - Engine Timing Tool Set

- For the professional engine repair
- Necessary to separate the V6 2 valve engine cam shafts from each other
- Very high degree of accuracy

**Application range:** Audi 80 (1991-2002) with 2.6 / 2.8 engines, A4 with 2.6 / 2.8 engines, 100 with 2.6 / 2.8 engines, A8 with 2.8 engines, Cabrio, Coupe with 2.6 / 2.8 engines (engine code: AAH, ABC)

Please carry out an up-to-date cross reference test for the specific vehicle on [www.timingtools.de](http://www.timingtools.de)

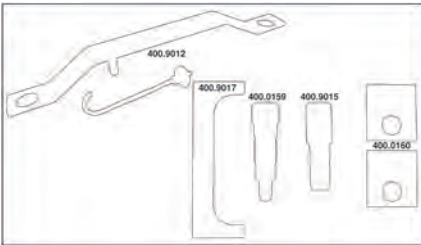
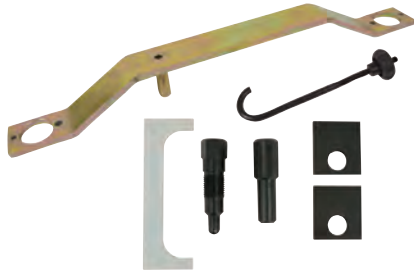
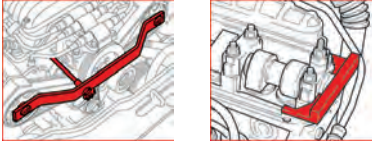

400.0225	6 pcs	VAG - Engine Timing Tool Set	3.02
----------	-------	------------------------------	------

consists of:

400.0159	Crankshaft timing pin	120
400.0160	Camshaft timing tool (2)	118
400.9012	Camshaft locking tool	2012
400.9015	Injection pump locking pin Ø 15.4 mm	126
400.9017	Camshaft setting strap	120

### VAG Camshaft fixing tool

- For the professional engine repair
- For locking the cam shafts
- Allows for correct engine adjustment
- Very high degree of accuracy

**Application range:** Audi 80, 90, A4, A6, A8 with 2.6 V6 12V engines (engine code: ABC, ACZ) and with 2.8 V6 12V engines (AAH, AEJ)

Please carry out an up-to-date cross reference test for the specific vehicle on [www.timingtools.de](http://www.timingtools.de)

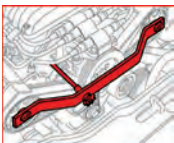

400.9012	VAG Camshaft fixing tool	2.01
----------	--------------------------	------

### VAG Camshaft fixing tool

- For the professional engine repair
- For locking the cam shafts
- Allows for correct engine adjustment
- Very high degree of accuracy

**Application range:** Audi A4 2.4 and 2.8 1997-2002, A6 2.4 1997-2002, A6 2.8 1997-2002, A8 2.8 1997-2002, S4 2.7 Turbo 1997-2001 and Volkswagen Passat 2.4 1996-2002, Passat 2.8 30V 1996-2001 (engine code: ACK, ALG, APR, AQR)

Please carry out an up-to-date cross reference test for the specific vehicle on [www.timingtools.de](http://www.timingtools.de)

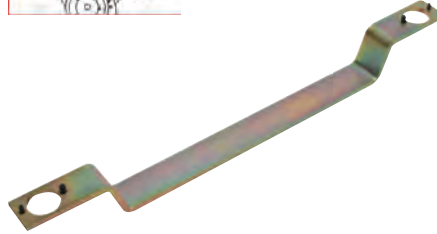
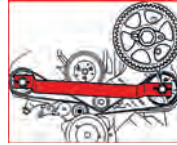

400.9013	VAG Camshaft fixing tool	2.41
----------	--------------------------	------

### VAG - Engine Timing Tool Set

- For the professional engine repair
- Range for changing timing belts or for working on timing devices
- Very high degree of accuracy
- In durable steel storage case

**Application range:** VAG group vehicles with 2.4 engines, in particular Volkswagen T2, T3, T4 Transporter, LT, Golf, Passat and Audi (engine code: AAB, AJA, ADG, ABL, 1X, 1Y, 1W, 1V, CS, CW, KY, JR, JX, JD, JP, 1Z, AAT, AEL, AAZ, AHU, AFN, AEY, AVG, ALE, AFF, AHH, ACV, AHY, AJT, AUF, AXG, AXL, AYC)

Please carry out an up-to-date cross reference test for the specific vehicle on [www.timingtools.de](http://www.timingtools.de)

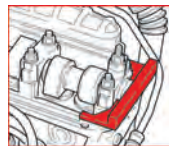

400.2125	5 pcs	VAG - Engine Timing Tool Set	951
----------	-------	------------------------------	-----

consists of:

400.0258	Shim tool (2)	3
400.9015	Injection pump locking pin Ø 15.4 mm	126
400.9017	Camshaft setting strap	120
400.9042	Pulley wheel counter hold wrench	714

### VAG pulley wheel counter hold wrench

- For the professional engine repair
- Simple assembly and disassembly of the crank shaft pulley wheel or vibration dampers
- Special profiles allows for counter holding when releasing or securing the crank shaft central screw
- The handle can be lengthened via the 3/4" internal square
- Very high degree of accuracy

**Application range:** VAG group vehicles with 2.4 engines, in particular Volkswagen T2, T3, T4 Transporter, LT, Golf, Passat and Audi (engine code: AAB, AJA, ADG, ABL, 1X, 1Y, 1W, 1V, CS, CW, KY, JR, JX, JD, JP, 1Z, AAT, AEL, AAZ, AHU, AFN, AEY, AVG, ALE, AFF, AHH, ACV, AHY, AJT, AUF, AXG, AXL, AYC)

Please carry out an up-to-date cross reference test for the specific vehicle on [www.timingtools.de](http://www.timingtools.de)



400.9042	VAG pulley wheel counter hold wrench	714
----------	--------------------------------------	-----

### VAG Camshaft ruler

- For the professional engine repair
- Ideally suited to fixing the cam shaft
- Simple handling
- Special steel
- Very high degree of accuracy

**Application range:** VAG group vehicles with diesel engines, in particular Volkswagen T2, T3, T4, LT, Golf, Passat, Audi with 2.4D 6 cylinder and 2.4 TD 5 cylinder TDI engines, as well as all older diesel engines such as 1.6 D and 1.7 D GTD (engine code: CS, CW, JD, JX, JP, JR, 1X, 1Y, 1Z, KY, AAZ, AAT, AEL, AFN, AFF, AHU, AHH, AVG, AAB, AJA, AHY)

Please carry out an up-to-date cross reference test for the specific vehicle on [www.timingtools.de](http://www.timingtools.de)

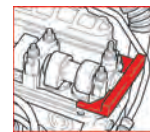

400.9017	VAG Camshaft ruler	120
----------	--------------------	-----

### VAG fixing pin injection pump wheel

- For the professional engine repair
- Ideally suited to securing the injection pump
- Simple handling
- Special steel
- Very high degree of accuracy

**Application range:** VAG group vehicles with diesel engines, in particular Volkswagen T2, T3, T4, LT, Golf, Passat, Audi with 2.4D 6 cylinder and 2.4 TD 5 cylinder TDI engines, as well as all older diesel engines such as 1.6 D and 1.7 D GTD (engine code: CS, CW, JD, JX, JP, JR, 1X, 1Y, 1Z, KY, AAZ, AAT, AEL, AFN, AFF, AHU, AHH, AVG, AAB, AJA, AHY)

Please carry out an up-to-date cross reference test for the specific vehicle on [www.timingtools.de](http://www.timingtools.de)



400.9015	VAG	Suitable for	Ø mm	Length mm	126
			15,4	67,0	

**VAG / Volvo - Engine Timing Tool Set**

- For the professional engine repair
- For locking the crank shaft or cam shaft
- For changing the timing belt
- Very high degree of accuracy

**Application range:** Audi, Seat, Volkswagen, Volvo vehicles

Please carry out an up-to-date cross reference test for the specific vehicle on [www.timingtools.de](http://www.timingtools.de)

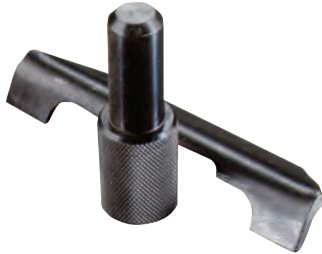
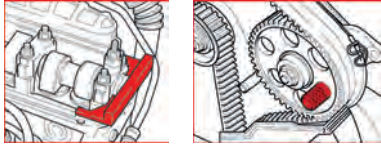

		🔧	
400.1725	2 pcs	VAG / Volvo - Engine Timing Tool Set	251

consists of:

		🔧	
400.9015	Injection pump locking pin Ø 15.4 mm		126
400.9017	Camshaft setting strap		120

**VAG - Engine Timing Tool Set**

- For the professional engine repair
- For locking the cam shaft
- For changing the timing belt
- Very high degree of accuracy

**Application range:** Volkswagen Crafter (2006-2009) with 2.5 TDi engine (engine code: BJJ / BJK / BJL / BJM)

Please carry out an up-to-date cross reference test for the specific vehicle on [www.timingtools.de](http://www.timingtools.de)

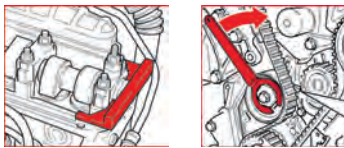

		🔧	
400.0975	5 pcs	VAG - Engine Timing Tool Set	255

consists of:

		🔧	
150.3016	Drive pulley wrench, 32, 175mm		110
400.0258	Shim tool (2)		3
400.0978	Crankshaft timing pin		103
400.9017	Camshaft setting strap		120

**VAG Drive pulley wrench 32.0 mm**

- For the professional engine repair
- Open 12-point
- For tightening and loosening the automatic timing belt pulley
- With plastic-coated handle
- With suspension hole
- Special steel
- Very high degree of accuracy

**Application range:** Audi 100, A4, A6 TDI 5 cylinder engines, Volkswagen Polo / Lupo from 1999 onwards, LT 2.5 TDI

Please carry out an up-to-date cross reference test for the specific vehicle on [www.timingtools.de](http://www.timingtools.de)

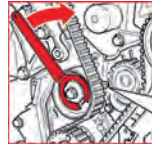

	Suitable for	🔧	L mm	Thickness mm	🔧
150.3016	VAG	32,0	175,0	3,0	110

**VAG - Engine Timing Tool Set**

- For the professional engine repair
- For TDI pump injection engines
- For changing the timing belt
- Secure hold for changing the timing belt or engine repairs

**Application range:** universal usage for many VAG group vehicles, in particular Audi A3, A4, A6, Škoda Octavia 2, Fabia, Volkswagen Golf, Golf Plus, Jetta, Touran, Lupo, Fox, Bora, Beetle, Caddy, Sharan, Passat, Seat Leon, Toldeo, Althea, Alhambra with 1.4 / 1.9 / 2.0 TDi engines

Please carry out an up-to-date cross reference test for the specific vehicle on [www.timingtools.de](http://www.timingtools.de)

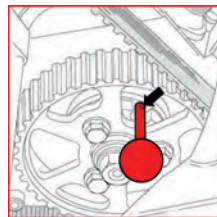

		🔧	
400.2700	7 pcs	VAG - Engine Timing Tool Set	455

consists of:

		🔧	
400.0615	Crankshaft pulley setting tool		190
400.0901	Tensioning locking pin		4
400.1415	Crankshaft pulley setting tool		192
400.1425	Tensioning locking pin		11
400.9018	Injection pump locking pin Ø 6.0 mm		20

**VAG Camshaft hub removal tool set**

- For the professional engine repair
- Suitable for the simple and correct removal of the cam shaft hub
- Counter hold wrench allows for a precise release or tightening of the cam shaft hub securing screw
- Special steel
- Very high degree of accuracy

**Application range:** Audi, Seat, Škoda and Volkswagen with 1.6 TDI and 2.0 TDI engines

Please carry out an up-to-date cross reference test for the specific vehicle on [www.timingtools.de](http://www.timingtools.de)

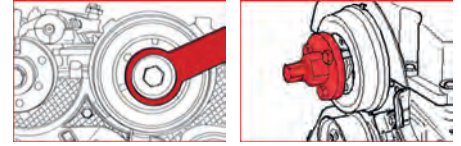

		🔧	
400.2110	2 pcs	VAG Camshaft hub removal tool set	760

consists of:

		🔧	
400.2104	Sprocket holding tool		179
400.2105	Cam sprocket hub puller		581

**VAG - Engine Timing Tool Set**

- For the professional engine repair
- For locking the crank shaft or cam shaft
- For changing the timing belt
- Very high degree of accuracy

**Application range:** Audi A4, A6, A8 with 2.5 TDI engines, Volkswagen Passat, Sharan with 2.5 TDI engines

Please carry out an up-to-date cross reference test for the specific vehicle on [www.timingtools.de](http://www.timingtools.de)

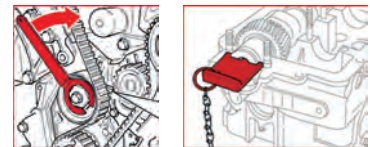

		🔧	
400.1550	5 pcs	VAG - Engine Timing Tool Set	560

consists of:

		X		🔧	
150.3012	2	VAG front mask push back		170	
400.0159	1	Crankshaft timing pin		120	
400.0160	1	Camshaft timing tool (2)		118	

### VAG small tension plate for arresting the automatic pulley

- For the professional engine repair
- Especially designed for fixing the hydraulic timing belt spanner
- Secure hold for changing the timing belt or engine repairs
- Very high degree of accuracy

Please carry out an up-to-date cross reference test for the specific vehicle on [www.timingtools.de](http://www.timingtools.de)

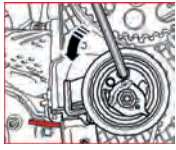

400.9019	VAG small tension plate for arresting the automatic pulley	20
----------	--	----

### VAG Crankshaft pulley bolt adaptor

- For the professional engine repair
- For turning the crank shaft on VAG engines
- Required for adjusting and turning the crank shaft when working on engine timing
- Can also be used as a counter holder
- Includes centring pin
- Burnished
- Very high degree of accuracy

**Application range:** Audi A4, A6, A8, Q7, 6 and 8 cylinder 2.4 and 3.2 L FSI as well as 6 and 8 cylinder TDI Common Rail

Please carry out an up-to-date cross reference test for the specific vehicle on [www.timingtools.de](http://www.timingtools.de)

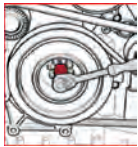

400.9043	VAG Crankshaft pulley bolt adaptor	140
----------	------------------------------------	-----

### VAG crank shaft timing belt puller

- For the professional engine repair
- For damage-free removal of crank shaft timing belt wheels
- Less space requirement through compact method of building
- Suited for work on engines in the vehicle or removed
- Special steel
- Very high degree of accuracy

**Application range:** Audi and Volkswagen with 4 and 5 cylinder engines

Please carry out an up-to-date cross reference test for the specific vehicle on [www.timingtools.de](http://www.timingtools.de)



Suitable for	Ø mm	Height mm	Weight
150.3154	VAG	65,0	75,0 440

### VAG Camshaft setting bracket

- For the professional engine repair
- For locking the cam shafts
- Allows for correct engine adjustment
- With central centring screw
- Removal of the valve cover and seal no longer required
- Very high degree of accuracy

**Application range:** Audi A4, Volkswagen Golf, Bora, New Beetle, Seat Ibiza, Cordoba, Alhambra, Inca, Skoda Octavia with 1.9 SDI or TDI engines (engine code: AHF, ALH, ASY, ASV, AGP, AGR, AQM, AHR, AYQ)

Please carry out an up-to-date cross reference test for the specific vehicle on [www.timingtools.de](http://www.timingtools.de)

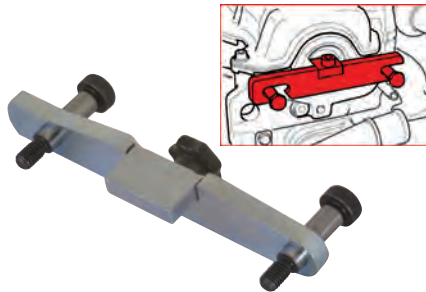

400.9044	VAG Camshaft setting bracket	309
----------	------------------------------	-----

### VAG Crank and camshaft locking tool set

- For the professional engine repair
- For TDI pump injection engines
- For changing the timing belt
- Secure hold for changing the timing belt or during engine repairs
- Special plastic
- Very high degree of accuracy

**Application range:** Volkswagen Golf, Passat, Lupo / Audi A2 and A3 from 2000 onwards

Please carry out an up-to-date cross reference test for the specific vehicle on [www.timingtools.de](http://www.timingtools.de)

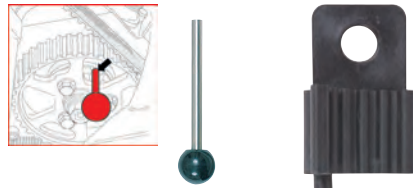

150.3066	2 pcs	VAG Crank and camshaft locking tool set	370
----------	-------	---	-----

### VAG Camshaft locking device

- For the professional engine repair
- For locking both cam shaft wheels (TDC setting)
- Secure hold thanks to optimal positioning
- Very high degree of accuracy

**Application range:** VAG 1.4 / 1.6 L petrol engines - Volkswagen Lupo, Polo, Golf IV, Bora, Audi A2, Seat, Skoda etc.

Please carry out an up-to-date cross reference test for the specific vehicle on [www.timingtools.de](http://www.timingtools.de)

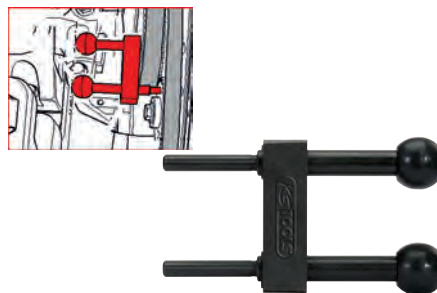

150.3034	VAG Camshaft locking device	370
----------	-----------------------------	-----

### VAG Crank shaft locking device

- For the professional engine repair
- For locking the oval crank shaft timing belt wheel
- Secure hold thanks to optimal positioning
- Very high degree of accuracy

**Application range:** VAG 4 cylinder diesel / Pump injection engines from 2005 onwards and VAG 2.0 I Common Rail diesel engines

Please carry out an up-to-date cross reference test for the specific vehicle on [www.timingtools.de](http://www.timingtools.de)



150.3067	VAG Crank shaft locking device	60
----------	--------------------------------	----

### VAG timing chain tensioning wrench

- For the professional engine repair
- For adjusting the timing chain tension
- For putting on the chain tensioner
- Very high degree of accuracy

**Application:** VAG Group vehicles with 4 valve engines 1.8 and 2.0 TFSI 4 cylinder from the 3rd generation (engine code: CCZA, CGZB, CGZC, CCZD, CDA, CCAB)

Please carry out an up-to-date cross reference test for the specific vehicle on [www.timingtools.de](http://www.timingtools.de)

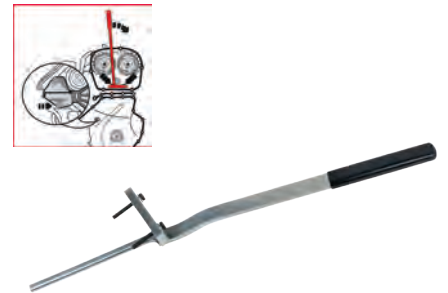

400.4350	VAG timing chain tensioning wrench	562
----------	------------------------------------	-----

### VAG Injection pump locking pin

- For the professional engine repair
- Ideally suited to securing the injection pump
- With air inlet
- Simple handling
- Special steel
- Very high degree of accuracy

**Application range:** Volkswagen Lupo 3L, 1.2/1.4 TDi, Polo 1.4 TDi, Golf / Bora 1.9 SDI / TDi, Passat 1.9 TD (1994-1996), Beetle 1.9 TDi (>1999) and Transporter 1.9TD

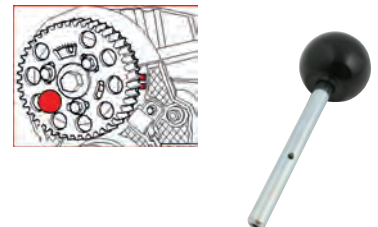

Suitable for	Ø mm	L mm	Weight
400.9018	VAG	6,0 80,0	20

### VAG Camshaft adjustment plate

- For the professional engine repair
- Device for a secure hold to change the timing belt
- For locking the cam shaft
- Secure hold thanks to optimal positioning
- Very high degree of accuracy

**Application:** VAG chain-driven Group vehicles with 2.3 / 2.8 and 2.9 engines, in particular Volkswagen Golf, Bora, Vento, Corrado, Passat, Sharon, Transporter, Seat Toledo

Please carry out an up-to-date cross reference test for the specific vehicle on [www.timingtools.de](http://www.timingtools.de)



400.9040	VAG Camshaft adjustment plate	57
----------	-------------------------------	----

### VAG 4/3 way cam shaft adjustment tool set

- For the professional engine repair
- For the installation and removal of the central cam shaft adjustment
- Saves removing the timing chain or removing the engine
- Very high degree of accuracy

**Application range:** VAG Group vehicles 1.8 and 2.0 litre TFSI / TSI engines with timing chains (engine codes: BYT / BZB / CABA / CABB / CABD / CAWB / CBFA / CCTA / CCZA / CCZB / CCZC / CDA / CDHA / CDHB / CDNB / CDNC / CDND / CDND / CFKA / CGYA / CCZA / CCZB / CCZD / CDA / CDABBYT / BZB / CABA / CABB / CABD / CAWB / CBFA / CCTA / CCZA / CCZB / CCZC / CDA / CDHA / CDHB / CDNB / CDNC / CDND / CFKA / CGYA / CCZA / CCZB / CCZD / CDA / CDABBYT)

Please carry out an up-to-date cross reference test for the specific vehicle on [www.timingtools.de](http://www.timingtools.de)

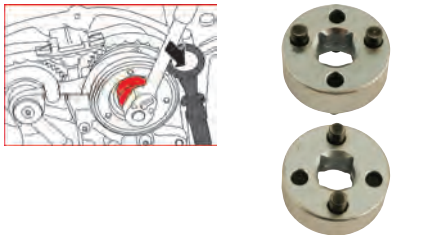

400.9094	2 pcs VAG 4/3 way cam shaft adjustment tool set	63
----------	---	----

### VAG automatic pulley wrench for pin-type face

- For tightening and relaxing the timing belt on VAG vehicles
- For pin spacers with driver bores (pin-type face)
- Cranked shape
- With plastic-coated handle

**Application range:** Audi, Volkswagen, Seat, Škoda 4 and 5 cylinder TDI engines, also Volkswagen T4 power steering pumps

Please carry out an up-to-date cross reference test for the specific vehicle on [www.timingtools.de](http://www.timingtools.de)

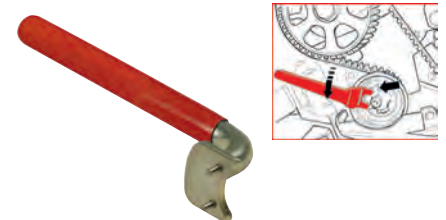

	Suitable for	L mm	g
400.9008	VAG	140.0	206
400.9009	VAG	210.0	263

### VAG automatic pulley wrench for pin-type face

- For the professional engine repair
- For tightening and relaxing the timing belt on VAG vehicles
- For pin spacers with driver bores (pin-type face)
- Angled shape
- With plastic-coated handle
- Very high degree of accuracy

**Application range:** Audi, Volkswagen, Seat, Škoda 4 and 5 cylinder TDI engines

Please carry out an up-to-date cross reference test for the specific vehicle on [www.timingtools.de](http://www.timingtools.de)

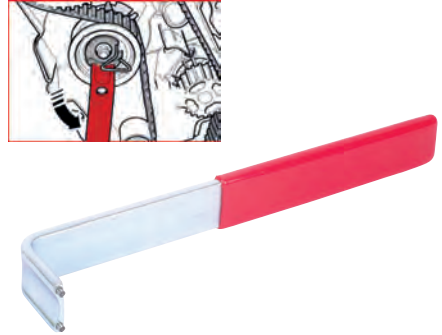

400.9010	VAG automatic pulley wrench for pin-type face	230
----------	---	-----

### VAG automatic pulley wrench for pin-type face

- For tightening and relaxing the timing belt on VAG vehicles
- For pin spacers with driver bores (pin-type face)
- 15° angled
- With plastic-coated handle

**Application range:** Audi, Volkswagen, Seat, Škoda 2.0 FSI/ TDI engines

Please carry out an up-to-date cross reference test for the specific vehicle on [www.timingtools.de](http://www.timingtools.de)

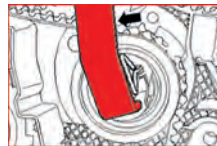

	Suitable for	Pin key mm	Stud Ø mm	g
400.9011	VAG	18.0	3.0	259

### VAG Pin wrench 3 mm, adjustable

- Universal usage
- For the actuation of belt tensioners in VAG
- Phosphate
- Special steel

Please carry out an up-to-date cross reference test for the specific vehicle on [www.timingtools.de](http://www.timingtools.de)



	Suitable for	Ø mm	L mm	g
150.3018	VAG	9.0-45.0	150.0	100

### VAG automatic pulley wrench for pin-type face

- For tightening and relaxing the timing belt on VAG vehicles
- 180° adjustable handle
- For pin spacers with tappet tolerances
- Normal and extra flat ideal for hard to access areas
- With plastic coated handle

**Application range:** VAG 4 and 5 cylinder TDI-Model, T4 Servo pump



	Suitable for	L mm	Stud Ø mm	Pin key mm	g
500.4315	VAG	180.0	3.0	18.0	95
150.3017	VAG	185.0	3.0	18.0	105

### VAG automatic pulley wrench set for 2.0 RDI PD engines

- Suitable for the assembly and disassembly of the timing belt
- For hard-to-reach places due to the modified support frame screws
- Chrome vanadium

**Application range:** Audi A3 2.0 TDI PD DPHC (05-08) with the engine ID codes AZU, BKD, BHN, BUY and Volkswagen Caddy, Caddy Maxi 2.0 SDI (09-) with BDJ, BST with engines with hydraulic spanners and Transporter 1.9 TDI Pd (06-09)

Please carry out an up-to-date cross reference test for the specific vehicle on [www.timingtools.de](http://www.timingtools.de)



400.2150	3 pcs VAG automatic pulley wrench set for 2.0 RDI PD engines	160
----------	--	-----

consists of:

		g
400.2151	Tensioner adjuster Ø 6.0 mm	20
400.2152	Tensioner adjuster Ø 3.9 mm	70
400.2153	Tensioner adjuster Ø 2.5 mm	70

### VAG front mask stub rod

- For moving the front mask (radiator support) forward in order to carry out service work
- Allows for timing belt changes or the renewal of the water pump
- Removes the need for the adjustment of the bonnet lock and the gap measurements

Please carry out an up-to-date cross reference test for the specific vehicle on [www.timingtools.de](http://www.timingtools.de)

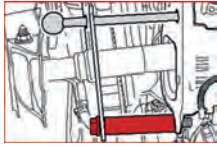

Suitable for	Ø mm	L mm	Content	g	
150.3012	VAG	M8	100.0	1	170

### VAG front mask guiding rods

- For moving the front mask (radiator support) forward in order to carry out service work
- Allows for timing belt changes or the renewal of the water pump
- Removes the need for the adjustment of the bonnet lock and the gap measurements

Please carry out an up-to-date cross reference test for the specific vehicle on [www.timingtools.de](http://www.timingtools.de)

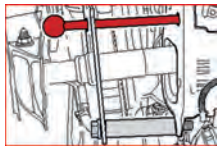

Suitable for	Ø mm	L mm	Content	g	
400.2077	VAG	M8	180.0	1	80
400.2078	VAG	M10	180.0	1	120

### VAG front mask guiding and stub rods set

- For moving the front mask (radiator support) forward in order to carry out service work
- Allows for timing belt changes or the renewal of the water pump
- Removes the need for the adjustment of the bonnet lock and the gap measurements

Please carry out an up-to-date cross reference test for the specific vehicle on [www.timingtools.de](http://www.timingtools.de)

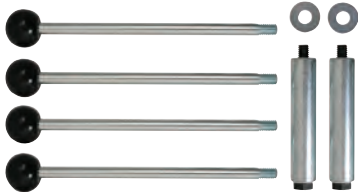
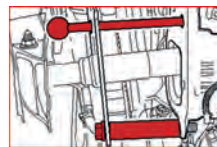

Suitable for	Ø mm	L mm	Content	g
400.2075	6 pcs	VAG front mask guiding and stub rods set		749

consists of:

X	g	
150.3012	2 VAG front mask push back	170
400.2077	1 Front mask removal aid (2)	80
400.2078	1 VAG front mask removal aid (2)	120

### VAG V belt and timing belt wrench

- For loosening the automatic clamping device
- Problem free changing of the belt
- For hard to reach places
- With plastic-coated handle
- Chrome vanadium

**Application range:** Audi, Seat, Škoda and Volkswagen with 2.0 TDI and 1.4 TSI engines  
**Volkswagen** Beetle (2011-2013), Eos (2007-2013), Golf (2003-2008), Golf (>2008), Golf Estate (2007-2009), Golf Estate (>2009), Gold Plus (2005-2009), Golf Plus (>2009), Golf VI Cabrio (>2011), Jetta (2005-2011), Jetta (>2011), Scirocco (>2008), Passat (2005-2011), Passat (>2011), Tiguan (2010-2013), Polo (>2009), Touran (2007-2013), **Audi** A1 (2010-2013), **Škoda** Octavia (>2004), Yeti (2010-2013), engine code: CAVD, CAXA, CAVB, CAVC



Suitable for	Ø mm	Length mm	g	
400.4300	VAG	16	380.0	501

### VAG Engine support socket set, extra short

- 12-point
- For the assembly and removal of the aluminium engine support (hard to reach sites)
- Ideal for timing belt change
- Internal square drive to DIN 3120 / ISO 1174 with ball reception
- Extra-short design
- For manual operation
- Matt finish
- Chrome vanadium

**Application range:** For timing belt change on Volkswagen Golf IV, Audi, Škoda, Seat etc.



Suitable for	g	
911.1295	2 pcs VAG Engine support socket set, extra short	110

consists of:

Suitable for	g	
911.1293	12 point socket, 16.0 mm short	40
911.1294	12 point socket, 16.0 mm long	67

### Hexagon socket, long for pulley wheel

- Suited for the assembly and disassembly of the pulley wheel vibration damper, e.g. when changing the timing belt
- 6-point
- FlankTraction-Profile
- In accordance with DIN 3124 / ISO 2725
- Internal square to DIN 3120 / ISO 1174 with ball reception
- Long design
- For manual operation
- Matt finish
- Chrome vanadium

**Application range:** Audi, Seat, Škoda and Volkswagen

Please carry out an up-to-date cross reference test for the specific vehicle on [www.timingtools.de](http://www.timingtools.de)

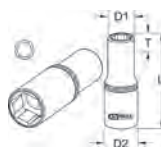

Suitable for	Ø mm	D1 mm	D2 mm	L mm	T mm	g
917.1254	27.0	34.0	36.0	76.0	19.0	280

### Bit socket for spline (XZN®) screws, long

- Ideal for releasing and tightening of the securing screws of the high-pressure pumps, timing belt wheels, e.g. when changing timing belt
- Spline (XZN®)
- Internal square drive to DIN 3120 / ISO 1174 with ball reception
- Long design
- With press fitted nickel plated insert bit
- For manual operation
- Matt finish
- Chrome vanadium

**Application range:** Audi, Seat, Škoda and Volkswagen with TDI Common Rail engines, engine code: CAAA, CAAB, CAAC, CAYB, CBAA, CBAB, CBBB etc.

Please carry out an up-to-date cross reference test for the specific vehicle on [www.timingtools.de](http://www.timingtools.de)



Suitable for	D mm	L mm	T mm	g	
911.1353	M10	22.0	110.0	72.0	112

### VAG Bit socket for hexagon screws, extra long

- Hexagon socket with ball head
- For releasing and tightening the TDC sensor
- Internal square drive to DIN 3120 / ISO 1174 with ball reception
- Extra-long design
- For manual operation
- Matt finish
- Chrome vanadium

**Application range:** VAG models from 2005, 4-cylinder 2.0l diesel engines



Suitable for	Ø mm	D mm	L mm	g
911.1598	4.0	11.0	300.0	80

### Impact bit socket for spline (XZN®) screws, long

- Ideally suited to releasing and tightening the securing screws on the cam shaft wheel
- Spline (XZN®)
- Internal square in accordance with DIN 3121 / ISO 1174
- Long design
- For machinery usage
- Phosphate
- Chrome molybdenum

**Application range:** Volkswagen Transporter >2004 with 2.5 TDI engines and Touareg >2003 with 2.5 TDI engines, engine code: AXD, BNZ, BAC and BPE

Please carry out an up-to-date cross reference test for the specific vehicle on [www.timingtools.de](http://www.timingtools.de)



Suitable for	L mm	D mm	T mm	g	
911.0953	M16	75.0	25.0	45.0	150



BMW

BMW - Engine Timing Tool Set

- For the professional engine repair
- Especially for chain-driven engines
- Very high degree of accuracy
- In durable steel storage case

**Application range:** BMW 3, 5, 7, X3, X5, Z3, Z4, 8 (E20, E28, E31, E32, E34, E36, E38, E46, E53, E65, E66, E83, E84) with petrol and diesel engines

Please carry out an up-to-date cross reference test for the specific vehicle on [www.timingtools.de](http://www.timingtools.de)

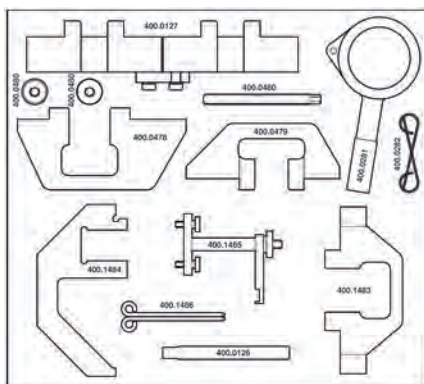

400.1475	16 pcs	BMW - Engine Timing Tool Set	5.32

consists of:

X			
400.0126	1	Crankshaft TDC locking pin	109
400.0127	1	Camshaft locking tool exhaust (2)	900
400.0478	1	Camshaft locking tool	854
400.0479	1	Camshaft locking tool	425
400.0480	1	Primary timing chain pre-load pin (3)	112
400.0481	1	VANOS unit engagement wrench	357

consists of:

X			
400.0482	2	Tensioner locking pin set	3
400.1483	1	Camshaft locking tool	731
400.1484	1	Camshaft locking tool	468
400.1485	1	Locking clamp for camshaft alignment tools	240
400.1486	1	Tensioner locking pin (2)	29

BMW - Engine Timing Tool Set

- For the professional engine repair
- For locking the cam shaft
- For changing the timing chain
- Very high degree of accuracy
- In durable steel storage case

**Application range:** BMW (E46) 316, 316ti Compact (engine code: N42 B18A / N46 B18), (E46) 318i, 318ti Compact (engine code: M42 B20A / N46 B18 / N46 B20), (E81/82/87) 118i, 120i (engine code: N46 B20B / N46T B20), (E90/91/92/93) 318i, 320i. (engine code: N46 B18B / N46 B20B), (E85) Z4 2.0 (engine code: N46 B20), (E83) X3 2.0 (engine code: N46 B20B)

Please carry out an up-to-date cross reference test for the specific vehicle on [www.timingtools.de](http://www.timingtools.de)

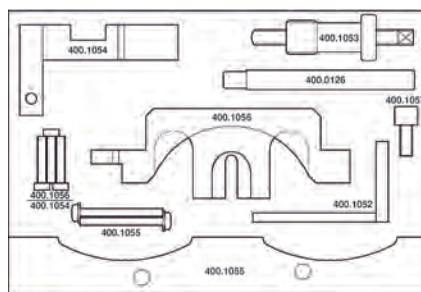
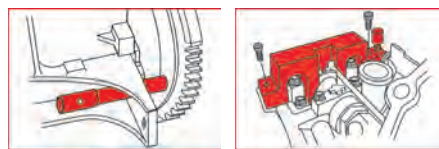

400.1050	10 pcs	BMW - Engine Timing Tool Set	2.10

consists of:

X			
400.0126	1	Crankshaft TDC locking pin	109
400.1052	1	Flywheel TDC locking pin	20
400.1053	1	Timing chain pre-tensioning tool	219
400.1054	1	Camshaft alignment tool (inlet)	262
400.1055	1	Sensor gear alignment tool	332
400.1056	1	Camshaft alignment tool exhaust (4)	677
400.1057	1	Camshaft alignment tool bolt M8 x 25 mm	15



BMW - Engine Timing Tool Set

- For the professional engine repair
- Especially for chain-driven vehicles
- For locking the crank shaft or cam shaft
- Ideal for the installation and removal of the VANOS unit
- Suitable for tensioning the chain
- Very high degree of accuracy
- In durable steel storage case

**Application range:** for all BMW vehicles with petrol engines (engine code: M42 / M43 / M50 / M52 / M60) and diesel engines (engine code: M51). Contains a special wrench for controlling the turn of the exhaust cam shaft pinion when removing and installing the VANOS unit. There is also a tensioning tool included for tensioning the timing chain

Please carry out an up-to-date cross reference test for the specific vehicle on [www.timingtools.de](http://www.timingtools.de)

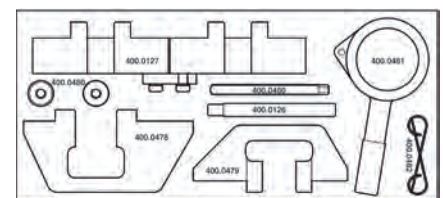
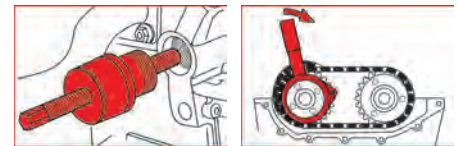

400.0475	11 pcs	BMW - Engine Timing Tool Set	4.08

consists of:

X			
400.0126	1	Crankshaft TDC locking pin	109
400.0127	1	Camshaft locking tool exhaust (2)	900
400.0478	1	Camshaft locking tool	854
400.0479	1	Camshaft locking tool	425
400.0480	1	Primary timing chain pre-load pin (3)	112
400.0481	1	VANOS unit engagement wrench	357
400.0482	2	Tensioner locking pin set	3

### BMW - Engine Timing Tool Set

- For the professional engine repair
- Expansion set for use in connection with 400.0125
- For changing the timing chain
- Very high degree of accuracy
- In durable steel storage case

**Application range:** BMW 528i, X5, E46, Z3, Z4, 325, 525 (engine code: M52 / M54 / M56 / 22 6S1 / 25 6S5 / 30 6S3). Contains a setting gauge from the double VANOS

Please carry out an up-to-date cross reference test for the specific vehicle on [www.timingtools.de](http://www.timingtools.de)

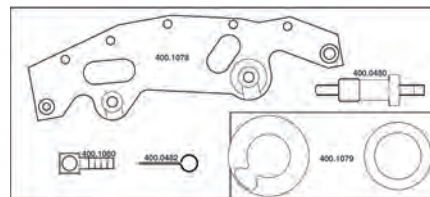
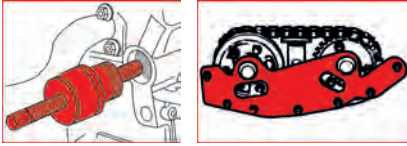

400.1075	7 pcs	BMW - Engine Timing Tool Set	3.56

consists of:

X		
400.0480	1 Primary timing chain pre-load pin (3)	112
400.0482	1 Tensioner locking pin set	3
400.1078	1 Camshaft timing setting tool VANOS	972
400.1079	1 Flywheel sprocket alignment tool	806
400.1080	1 Pneumatic connector	37

### BMW - Engine Timing Tool Set

- For the professional engine repair
- Especially for chain-driven vehicles
- For locking twin-cam, dual cam shaft
- Very high degree of accuracy
- In durable steel storage case

**Application range:** for all BMW vehicles with petrol engines (engine code: M42 / M43 / M50 / M52 / M60) and diesel engines (engine code: M51)

Please carry out an up-to-date cross reference test for the specific vehicle on [www.timingtools.de](http://www.timingtools.de)

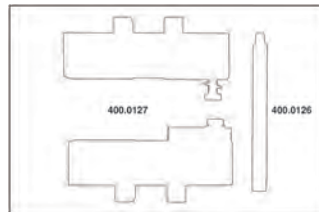
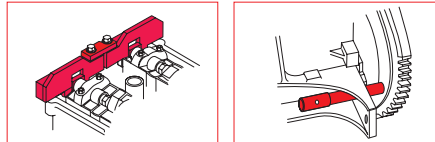

400.0125	3 pcs	BMW - Engine Timing Tool Set	2.66

consists of:

400.0126	1	Crankshaft TDC locking pin	109
400.0127	2	Camshaft locking tool exhaust (2)	900

### BMW / Mini - Engine Timing Tool Set

- For the professional engine repair
- For locking the cam shaft
- For changing the timing chain
- Very high degree of accuracy

**Application range:** BMW Mini (2001-2006) (engine code: W10B16AA/BA)

Please carry out an up-to-date cross reference test for the specific vehicle on [www.timingtools.de](http://www.timingtools.de)

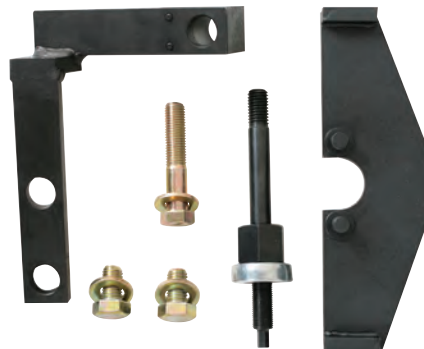
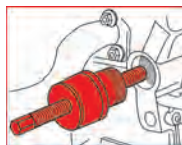

400.9090	7 pcs	BMW / Mini - Engine Timing Tool Set	1.93

consists of:

400.9091	1	Camshaft locking tool	575
400.9092	4	Engine support bracket (4)	615
400.9093	1	Timing chain pre-tensioning tool	215

### BMW / Mini - Engine Timing Tool Set

- For the professional engine repair
- For locking the cam shaft
- For changing the timing chain
- Very high degree of accuracy
- In durable steel storage case

**Application range:** BMW Mini One, Cooper, Cooper S with 1.6 petrol engines (engine code: W10816AA / W10816BA / W11816AA)

Please carry out an up-to-date cross reference test for the specific vehicle on [www.timingtools.de](http://www.timingtools.de)

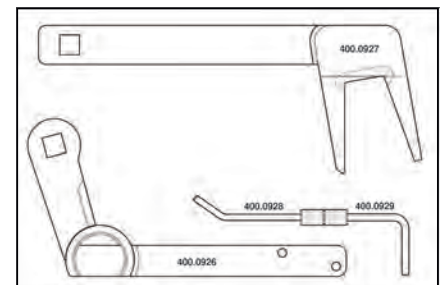

400.0925	4 pcs	BMW / Mini - Engine Timing Tool Set	2.02

consists of:

400.0926	1	Serpentine belt tensioner	441
400.0927	2	Camshaft pulley loosening tools	421
400.0928	1	Tensioning locking pin	19
400.0929	1	Locking pin	20



**BMW crank shaft locking tool set**

- For the professional engine repair
- For fixing the crank shaft
- Secure fix
- Very high degree of accuracy

**Application range:** BMW E81/E82/E87/E88/E46/E60/E61/E83/E90/E91/E92/E93/E65/E66/E53/E70/E71/E72 (engine code: 20 4D 4, 30 6D 2, 30 6D 3, 30 6D 4, 30 6D 5)

Please carry out an up-to-date cross reference test for the specific vehicle on [www.timingtools.de](http://www.timingtools.de)



400.2375	2 pcs	BMW crank shaft locking tool set	127
----------	-------	----------------------------------	-----

consists of:

400.2376	Crankshaft timing tool	52
400.2377	Crankshaft timing tool	55

**BMW / Land Rover / Rover - Engine Timing Tool Set**

- For the professional engine repair
- For locking the crank shaft or cam shaft
- For changing the timing belt or the timing chain
- Very high degree of accuracy
- In durable steel storage case

**Application range:** BMW 1, 3, 5, X3, Land Rover Freelander, Rover 75 (engine code: M47)

Please carry out an up-to-date cross reference test for the specific vehicle on [www.timingtools.de](http://www.timingtools.de)

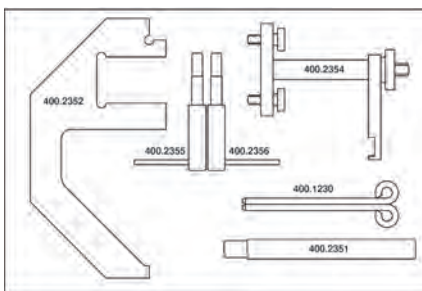

400.2350	7 pcs	BMW / Land Rover / Rover - Engine Timing Tool Set	1.03
----------	-------	---	------

consists of:

400.1230	Tensioning locking pin (2)	14
400.2351	Crankshaft TDC locking pin	108
400.2352	Camshaft locking tool	461
400.2354	Camshaft locking holding tool	240
400.2355	Crankshaft timing tool	52
400.2356	Crankshaft timing tool	55

**BMW / Mini / PSA - Engine Timing Tool Set**

- For the professional engine repair
- For locking the cam shaft
- For changing the timing chain
- Very high degree of accuracy
- In durable steel storage case

**Application range:** BMW Mini with 1.6 engines (engine code: N14 / R56), Peugeot 207, 308 with 1.6 engines (engine code: EP6 / EP6DT / DTS), Citroën with 1.6 engines (engine code: EP6 / EP6DT / DTS)

Please carry out an up-to-date cross reference test for the specific vehicle on [www.timingtools.de](http://www.timingtools.de)

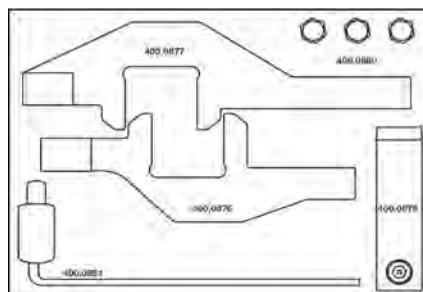
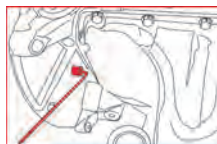

400.0875	7 pcs	BMW / Mini / PSA - Engine Timing Tool Set	1.49
----------	-------	---	------

consists of:

400.0851	Crankshaft timing pin	52
400.0876	Camshaft alignment tool (inlet)	270
400.0877	Camshaft alignment tool (exhaust)	423
400.0878	Support clamp	93
400.0880	Screw M6 x 30,0 mm (3)	7

**BMW / Mini / PSA - Engine Timing Tool Set**

- For the professional engine repair
- For locking the cam shaft
- For changing the timing chain
- Very high degree of accuracy

**Application range:** BMW Mini with 1.4 / 1.6 Valvetronic engines (engine code: N12), Peugeot 207, 308 with 1.4 / 1.6 engines (engine code: EP3 / EP6), Citroën with 1.4 / 1.6 engines (engine code: EP3 / EP6)

Please carry out an up-to-date cross reference test for the specific vehicle on [www.timingtools.de](http://www.timingtools.de)

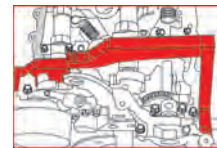

400.0850	7 pcs	BMW / Mini / PSA - Engine Timing Tool Set	1.40
----------	-------	---	------

consists of:

	X		
400.0851	1	Crankshaft timing pin	52
400.0852	1	Camshaft locking tool inlet (2)	812
400.0853	1	Camshaft locking tool (EX)	358
400.0854	3	Screw M6 x 30,0 mm	9

**BMW - Engine Timing Tool Set**

- For the professional engine repair
- For locking the cam shaft
- For changing the timing chain
- Very high degree of accuracy
- In durable steel storage case

**Application range:** BMW with 1.6 / 2.0 engines (>2006) (engine codes: N43 / B126A/AA / B16AA / B20KO / B20AY / B20A / B16AA/OO / B20AY / B20UO / B20A / B20A/AA)

Please carry out an up-to-date cross reference test for the specific vehicle on [www.timingtools.de](http://www.timingtools.de)

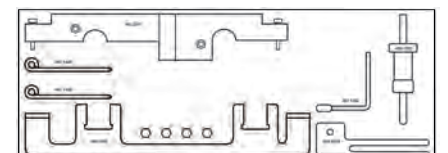
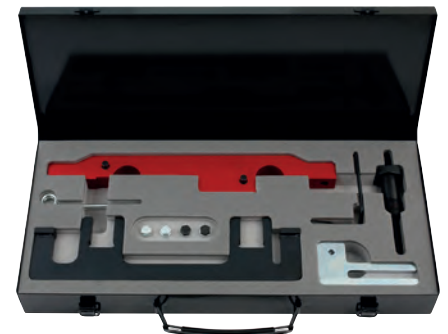
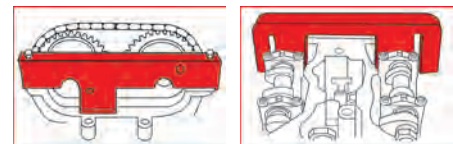

400.3200	7 pcs	BMW - Engine Timing Tool Set	3.09
----------	-------	------------------------------	------

consists of:

400.1052	Flywheel TDC locking pin	20
400.1053	Timing chain pre-tensioning tool	219
400.1485	Locking clamp for camshaft alignment tools	240
400.3201	VANOS Sensor alignment tool	457
400.3202	Camshaft alignment tool	683
400.3203	Balance shaft locking tool	100

### BMW / Mini - Engine Timing Tool Set

- For the professional engine repair
- For changing the timing belt
- Very high degree of accuracy

**Application range:** BMW Mini with 16V engines (engine code: W16D)

Please carry out an up-to-date cross reference test for the specific vehicle on [www.timingtools.de](http://www.timingtools.de)



400.2475	7 pcs BMW / Mini - Engine Timing Tool Set	126

consists of:

400.0165	Camshaft locking pin 5.0 mm	19
400.0580	Crankshaft locking pin Ø 8,0 mm	30
400.2476	Flywheel locking pin, BMW-Mini (3)	40

### BMW - Engine Timing Tool Set

- For the professional engine repair
- For chain-driven engines
- Very high degree of accuracy
- In durable steel storage case

**Application range:** BMW 5, 6, 7, X5 (engine code: N62 / N73)

Please carry out an up-to-date cross reference test for the specific vehicle on [www.timingtools.de](http://www.timingtools.de)

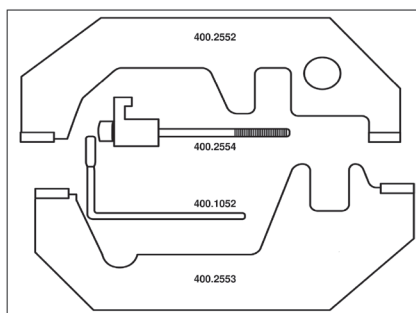
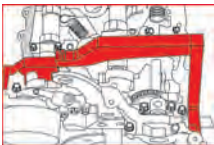

400.2550	4 pcs BMW - Engine Timing Tool Set	2.74

consists of:

400.1052	Flywheel TDC locking pin	20
400.2552	Camshaft setting tool (inlet)	698
400.2553	Camshaft setting tool (exhaust)	783
400.2554	Holding screw	105

### BMW / Mini - Engine Timing Tool Set

- For the professional engine repair
- For locking the cam shaft
- For changing the timing chain
- Very high degree of accuracy
- In durable steel storage case

**Application range:** BMW with 2.0 engines (2007-2010) (engine codes: N47 / N47S), BMW Mini Countryman, Clubman (>2007) (engine code: R55 / R56 / R57 / R60). Contains pumps / pulley wheels disassembly tool

Please carry out an up-to-date cross reference test for the specific vehicle on [www.timingtools.de](http://www.timingtools.de)

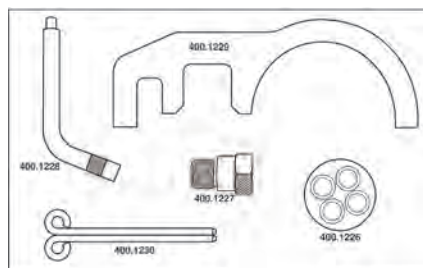
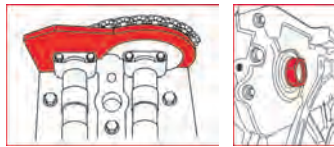

400.1225	6 pcs BMW / Mini - Engine Timing Tool Set	1.91

consists of:

400.1226	Crankshaft pulley turning tool	183
400.1227	High pressure pump sprocket removal tool	89
400.1228	Flywheel plate timing pin	109
400.1229	Camshaft alignment tool	242
400.1230	Tensioning locking pin (2)	14

### BMW - Engine Timing Tool Set

- For the professional engine repair
- For locking the cam shaft
- For changing the timing chain
- Very high degree of accuracy
- In durable steel storage case

**Application range:** BMW (E81/E87) 116i 316i, (E46/E40) 316Ci, (E46) 316Ti with 1.6 engines (engine code: N40 / N45 / N45T)

Please carry out an up-to-date cross reference test for the specific vehicle on [www.timingtools.de](http://www.timingtools.de)

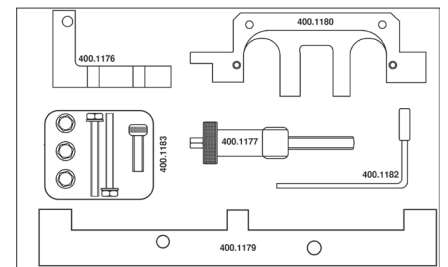
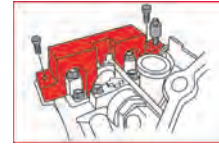

400.1175	8 pcs BMW - Engine Timing Tool Set	2.70

consists of:

400.1176	Camshaft locking tool (inlet)	278
400.1177	Timing chain pre-tensioning tool	55
400.1179	VANOS sensor setting tool	301
400.1180	Camshaft alignment tool (exhaust)	671
400.1182	Flywheel locking pin	20
400.1183	Locking screw (3)	140



**BMW - Engine Timing Tool Set**

- For the professional engine repair
- For locking the cam shaft
- For changing the timing chain
- Very high degree of accuracy
- In durable steel storage case

**Application range:** BMW 323i, 325i, 523i, Z4, X3, 130i, 330i, 530i, 630i, 730i, 528i, X1, 125i, 525i, 740i, X6, 135i, 335i, 3.0 M Coupe with 2.3 / 2.8 / 3.0 / 3.5 / 4.0 engines (engine code: N52 B25A / N52 B25AE / N52 B25AF / N52 B25BE / N52 B25O1 / N52 B25O2 / N52 B30A / N52 B30AF / N52 B30O2 / N52 B30U1 / N52K B25A/O1 / N52K B25AE / N52K B25U1 / N52K B30A / N52K / B30A/O1 / N52K B30AE / N52K B30AF / N53 B25A / N53 B30A / N53 B30A/O0 / N53 B30UO / N54 B30A / N54 B30A/AA / N54 B30A/TO / N54 B30TO)

Please carry out an up-to-date cross reference test for the specific vehicle on [www.timingtools.de](http://www.timingtools.de)

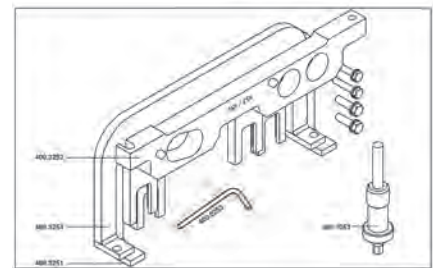
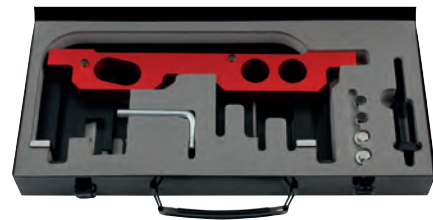
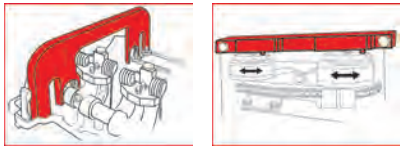

400.3250	5 pcs	BMW - Engine Timing Tool Set	5.40
----------	-------	------------------------------	------

consists of:

400.0253	Locking pin Ø 8.0 mm	41
400.1053	Timing chain pre-tensioning tool	219
400.3251	Camshaft alignment tool	1396
400.3252	Camshaft VANOS sensor alignment tool	527
400.3254	Camshaft alignment tool	1518

**BMW Vibration damper holding screw set**

- For clamping the crank shaft when loosening and tightening the crankshaft central screw
- Prevents slipping whilst holding
- With replaceable and tight-fit guide sleeves (Ø 57.0 / 59.5 / 60.5 mm)
- Minimal force required thanks to extra-long lever
- Matt finish
- Chrome vanadium

**Application range:** When working on the timing drive of BMW M47 TU / TU2 engines with old and new vibration damper design

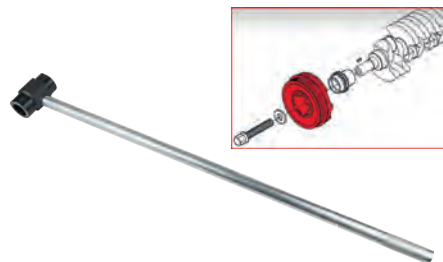

911.1720	5 pcs	BMW Vibration damper holding screw set	4.60
----------	-------	--	------

consists of:

911.1721	Extension pipe, 1000 mm	1900
911.1722	Vibration damper holding wrench insert, 22.0 mm	1400
911.1723	Guide sleeve, Ø 57.0 mm	380
911.1724	Guide sleeve, Ø 59.5 mm	440
911.1725	Guide sleeve, Ø 60.5 mm	480

**CHRYSLER**

**Chrysler / Mercedes - Engine Timing Tool Set**

- For the professional engine repair
- For locking the cam shaft
- For changing the timing chain
- Very high degree of accuracy
- In durable steel storage case

**Application range:** Mercedes vehicles with 2.2 / 2.7 CRD engines, Chrysler PT Cruiser with 2.2 CRD engines, Jeep Grand Cherokee with 2.7 CRD engines

Please carry out an up-to-date cross reference test for the specific vehicle on [www.timingtools.de](http://www.timingtools.de)

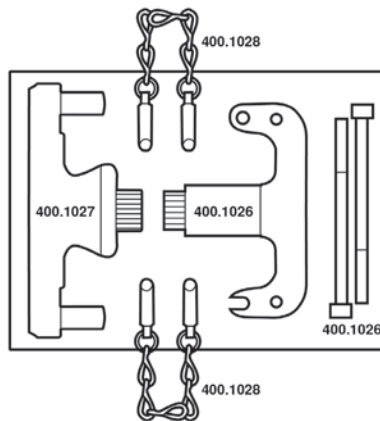
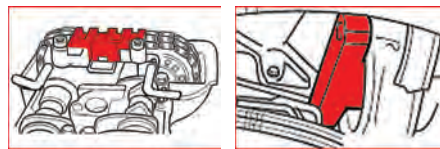

400.1025	6 pcs	Chrysler / Mercedes - Engine Timing Tool Set	1.46
----------	-------	--	------

consists of:

400.1026	Flywheel locking tool (3)	197
400.1027	Flywheel locking tool	436
400.1028	Camshaft locking tool (2)	36

**Chrysler - Engine Timing Tool Set**

- For the professional engine repair
- For locking the cam shaft
- Very high degree of accuracy

**Application range:** Chrysler Voyager, Grand Voyager with 2.5 CRD Common-Rail Diesel engines (engine code: R2516C / R2516I)

Please carry out an up-to-date cross reference test for the specific vehicle on [www.timingtools.de](http://www.timingtools.de)

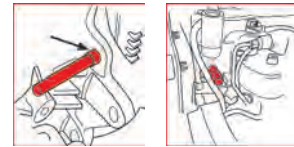

400.2450	7 pcs	Chrysler - Engine Timing Tool Set	514
----------	-------	-----------------------------------	-----

consists of:

400.2451	Flywheel locking pin	35
400.2452	Flywheel locking pin	420
400.2453	Camshaft locking pin (inlet)	89
400.2454	Camshaft locking pin (exhaust)	30
400.2455	Camshaft belt holding tool	7
400.9008	Automatic pulley wrench for pin-type face	206

**Chrysler - Engine Timing Tool Set**

- For the professional engine repair
- For locking the crank shaft and cam shaft
- For changing the timing belt
- Very high degree of accuracy

**Application range:** Jeep Cherokee (2008-2011) with 2.8 CRD (engine code: ENS(51C), Chrysler Grand Voyager (2008-2011) (engine code: VM64C)

Please carry out an up-to-date cross reference test for the specific vehicle on [www.timingtools.de](http://www.timingtools.de)

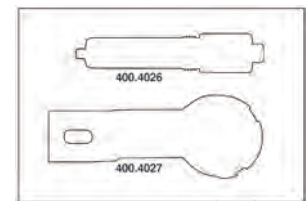
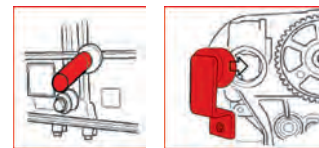

400.4025	2 pcs	Chrysler - Engine Timing Tool Set	500
----------	-------	-----------------------------------	-----

consists of:

400.4026	Crankshaft locking tool	160
400.4027	Camshaft locking tool	340

## CITROËN

### PSA - Engine Timing Tool Set

- For the professional engine repair
- For changing the timing belt
- Very high degree of accuracy
- In durable steel storage case

**Application range:** Citroën, Peugeot vehicles with HPI and HDi engines

Please carry out an up-to-date cross reference test for the specific vehicle on [www.timingtools.de](http://www.timingtools.de)

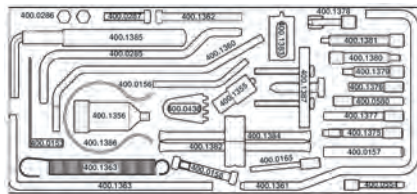
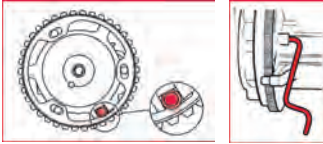

			🔑
400.1650	34 pcs	PSA - Engine Timing Tool Set	2.17

consists of:

			🔑
400.0153	Tensioner adjuster, square 8.0 mm	6	
400.0156	Crankshaft timing pin Ø 6.0 mm	23	
400.0157	Crankshaft locking pin Ø 6.0 mm, short (2)	101	
400.0158	Crankshaft locking pin (2)	30	
400.0165	Camshaft locking pin 5.0 mm	19	
400.0285	Crankshaft locking pin Ø 8,0 mm	97	
400.0286	Screw M8 x 35 mm (2)	16	
400.0436	Flywheel locking tool	135	
400.0554	Locking pin Ø 6.0 mm	19	
400.0580	Crankshaft locking pin Ø 8,0 mm	30	
400.1355	Flywheel locking pin	80	
400.1356	Flywheel locking tool	252	
400.1360	Flywheel locking tool	82	
400.1361	Flywheel locking tool	146	
400.1362	Locking screw M8 x 70.0 mm	31	
400.1363	Flywheel locking pin with spring	126	
400.1375	Injection pump timing pin, M8	32	
400.1376	Camshaft locking pin	24	
400.1377	Tensioning locking pin	35	
400.1378	Camshaft locking pin (2)	21	
400.1379	Camshaft locking pin	37	
400.1380	Camshaft locking pin	43	
400.1381	Camshaft locking pin (VTC)	50	
400.1382	Tensioner adjuster	115	
400.1383	Flywheel locking tool	30	
400.1384	Tensioner adjuster	118	
400.1385	Tensioner adjuster, hex Ø 8.0 mm	177	
400.1386	Belt retaining tool	50	
400.1387	Crankshaft pulley remover	153	

### PSA - Engine Timing Tool Set

- For the professional engine repair
- For changing the timing belt
- Very high degree of accuracy
- In durable steel storage case

**Application range:** PSA vehicles including 2nd generation with EW 16V and 2.5 / 2.7 / 2.8 diesel engines

Please carry out an up-to-date cross reference test for the specific vehicle on [www.timingtools.de](http://www.timingtools.de)

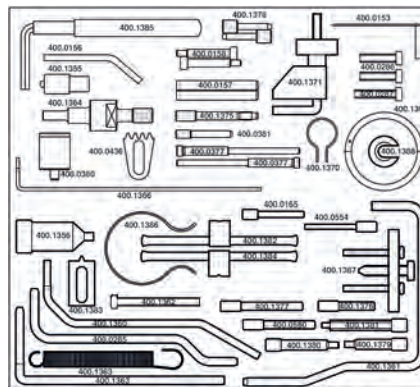
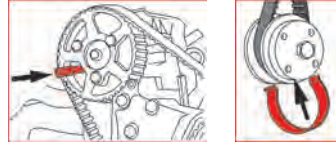

			🔑
400.1350	45 pcs	PSA - Engine Timing Tool Set	5.93

consists of:

			🔑
400.0153	1	Tensioner adjuster, square 8.0 mm	6
400.0156	1	Crankshaft timing pin Ø 6.0 mm	23
400.0157	1	Crankshaft locking pin Ø 6.0 mm, short (2)	101
400.0158	1	Crankshaft locking pin (2)	30
400.0165	2	Camshaft locking pin 5.0 mm	19
400.0285	1	Crankshaft locking pin Ø 8,0 mm	97
400.0286	1	Screw M8 x 35 mm (2)	16
400.0287	1	Screw M8 x 40,0 mm	18
400.0377	1	Camshaft sprocket locking pin (2)	68
400.0380	1	Flywheel locking tool	222
400.0381	1	Coolant Pump tensioning locking pin	30
400.0436	1	Flywheel locking tool	135
400.0554	1	Locking pin Ø 6.0 mm	19
400.0580	1	Crankshaft locking pin Ø 8,0 mm	30
400.1355	1	Flywheel locking pin	80

consists of:

			🔑
400.1356	1	Flywheel locking tool	252
400.1360	1	Flywheel locking tool	82
400.1361	1	Flywheel locking tool	146
400.1362	1	Locking screw M8 x 70.0 mm	31
400.1363	1	Flywheel locking pin with spring	126
400.1364	1	Flywheel locking pin	215
400.1365	1	Tensioner pulley adjusting tool	330
400.1366	1	Tensioner adjuster, square, 6.0 mm	44
400.1370	1	Crankshaft sprocket centraliser	2
400.1371	1	Belt retaining tool	99
400.1375	1	Injection pump timing pin, M8	32
400.1376	1	Camshaft locking pin	24
400.1377	1	Tensioning locking pin	35
400.1378	1	Camshaft locking pin (2)	21
400.1379	1	Camshaft locking pin	37
400.1380	1	Camshaft locking pin	43
400.1381	1	Camshaft locking pin (VTC)	50
400.1382	1	Tensioner adjuster	115
400.1383	1	Flywheel locking tool	30
400.1384	1	Tensioner adjuster	118
400.1385	1	Tensioner adjuster, hex Ø 8.0 mm	177
400.1386	1	Belt retaining tool	50
400.1387	1	Crankshaft pulley remover	153
400.1388	1	Tensioner adjuster	41

### BMW / Mini / PSA - Engine Timing Tool Set

- For the professional engine repair
- For locking the cam shaft
- For changing the timing chain
- Very high degree of accuracy
- In durable steel storage case

**Application range:** BMW Mini with 1.6 engines (engine code: N14 / R56), Peugeot 207, 308 with 1.6 engines (engine code: EP6 / EP6DT / DTS), Citroën with 1.6 engines (engine code: EP6 / EP6DT / DTS)

Please carry out an up-to-date cross reference test for the specific vehicle on [www.timingtools.de](http://www.timingtools.de)

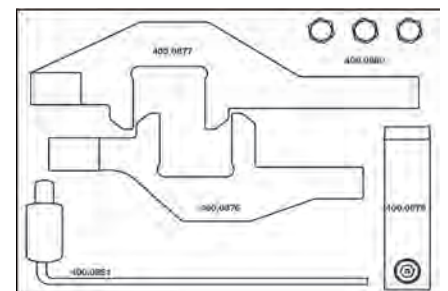
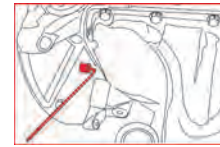

			🔑
400.0875	7 pcs	BMW / Mini / PSA - Engine Timing Tool Set	1.49



consists of:

400.1377	Tensioning locking pin	35
400.1383	Flywheel locking tool	30
400.1384	Tensioner adjuster	118
400.1386	Belt retaining tool	50
400.1387	Crankshaft pulley remover	153
400.3102	Tensioner locking pin	4
400.3151	Crankshaft pulley centralisation tool	2
400.3152	Tensioner locking pin	7
400.3154	Auxiliary drive belt tensioner locking pin Ø 4.0 mm	18

### PSA - Engine Timing Tool Set

- For the professional engine repair
- For locking the crank shaft or cam shaft
- For changing the timing belt
- Very high degree of accuracy

**Application range:** PSA vehicles with 1.4 8V and 16V engines (engine code: KFU)

Please carry out an up-to-date cross reference test for the specific vehicle on [www.timingtools.de](http://www.timingtools.de)

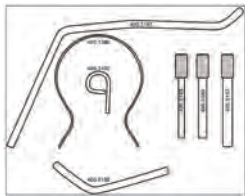
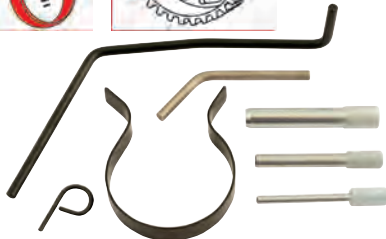

400.3100	9 pcs PSA - Engine Timing Tool Set	362

consists of:

400.0156	Crankshaft timing pin Ø 6,0 mm	23
400.0157	Crankshaft locking pin Ø 6,0 mm, short (2)	101
400.0165	Camshaft locking pin 5,0 mm	19
400.0580	Crankshaft locking pin Ø 8,0 mm	30
400.1386	Belt retaining tool	50
400.3101	Flywheel locking pin Ø 6,0 mm, long	58
400.3102	Tensioner locking pin	4

### BMW / Mini / PSA - Engine Timing Tool Set

- For the professional engine repair
- For locking the cam shaft
- For changing the timing chain
- Very high degree of accuracy

**Application range:** BMW Mini with 1.4 / 1.6 Valvetronic engines (engine code: N12), Peugeot 207, 308 with 1.4 / 1.6 engines (engine code: EP3 / EP6), Citroën with 1.4 / 1.6 engines (engine code: EP3 / EP6)

Please carry out an up-to-date cross reference test for the specific vehicle on [www.timingtools.de](http://www.timingtools.de)



400.0850	7 pcs BMW / Mini / PSA - Engine Timing Tool Set	1,40

consists of:

X		
400.0851	1 Crankshaft timing pin	52
400.0852	1 Camshaft locking tool inlet (2)	812
400.0853	1 Camshaft locking tool (EX)	358
400.0854	3 Screwn M6 x 30,0 mm	9

### PSA / Renault - Engine Timing Tool Set

- For the professional engine repair
- For changing the timing belt
- Very high degree of accuracy
- In durable steel storage case

**Application range:** Citroën XM, Peugeot 605, Renault Safrane, Espace (engine code: L7X 700 / 701 / 713 / 727 / 731 / XFZ / ES9J4)

Please carry out an up-to-date cross reference test for the specific vehicle on [www.timingtools.de](http://www.timingtools.de)

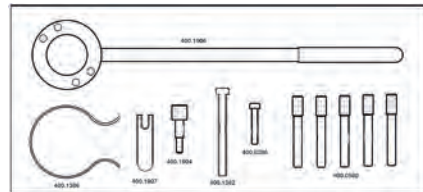
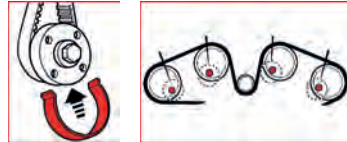

400.1900	11 pcs PSA / Renault - Engine Timing Tool Set	2,31

consists of:

X		
400.0286	1 Screw M8 x 35 mm (2)	16
400.0580	5 Crankshaft locking pin Ø 8,0 mm	30
400.1362	1 Locking screw M8 x 70,0 mm	31
400.1386	1 Belt retaining tool	50
400.1904	1 Gauge pin	14
400.1906	1 Camshaft locking tool	896

### PSA / Toyota timing belt tensioning tool

- For the professional engine repair
- 7,0 mm square
- Suitable for pre-tensioning timing belt tensioner on the automatic pulley
- Chrome vanadium
- Very high degree of accuracy

**Application range:** universal usage on many Peugeot and Toyota vehicles

Please carry out an up-to-date cross reference test for the specific vehicle on [www.timingtools.de](http://www.timingtools.de)



150.3011	PSA, Toyota	157,0 80

### PSA timing belt tensioning tool

- For the professional engine repair
- 8,0 mm square
- Suitable for pre-tensioning timing belt tensioner on the automatic pulley
- Chrome vanadium
- Very high degree of accuracy

**Application range:** universal usage on many Peugeot vehicles

Please carry out an up-to-date cross reference test for the specific vehicle on [www.timingtools.de](http://www.timingtools.de)



Suitable for		Length mm	
150.3014	PSA	157,0	100

### Universal fly wheel locking tool set

- For the professional engine repair
- For locking the fly wheels
- Secure hold thanks to optimal positioning
- Special plastic
- Very high degree of accuracy

**A Fly wheel Locking device for:** Citroën: Synergie 2.0/ Turbo.ZX 1.9D/TD, Xantia 1.9D/TD, Berlingo 1.9D, Dispatch 1.9D/TD, Synergie 1.9D, Relay 1.9D/TD, Fiat: Ulysse, 2.0/Turbo Ducato 2.0, FSO: 1.9D, LDV: 200 1.9D, Pilot 1.9D, Peugeot: 205 1.6/1.9, 305 1.6/1.9, 309 1.6/1.9, 405 1.6/1.9, 405 1.8/2.0 (92-), 605 2.0, Boxer 2.0, c205 1.8/1.9D, 305 1.8/1.9D, 306 1.8/1.9D/TD, 309 1.8/1.9D 1.8TD, 405 1.8TD, 405 1.9D, 406 1.9D, Partner 1.9D, Talbot / Horizon / Solara 1.9D, J5/Talbot Express 1.9D, 605D/TD, 806 1.9TD, Expert 1.9D, Boxer 1.9D/TD, Renault: R5, 1.6D, R9 1.6D, 411 1.6D Express/Extra 1.6D-F8M diesel engines, Clio, Express/Extra, 1.9D earlier F8Q diesel engines, Espace 2.1D, R21 2.1D, R25 2.1D, Trafic/ Master 2.1D-J8S diesel engines, Clio 1.2/1.4, Express/Extra, R19 1.4, Megane/Scenic 1.4/1.6-E7F/E7J petrol engines, R5 1.7, Clio 1.7/1.8, R19 1.7, R21 1.7 1.7 Megane/Scenic 2.0, Laguna 1.8/2.0, Trafic 1.7-F3N/F3P/F2R petrol engines, Clio, Williams, R19, Megane 2.0 16V Twin-Cam F7P/F7R engines, Laguna/ Safrane 2.0 16V Twin-Cam N7Q/N7U engines

**B Fly wheel Locking device for:** Renault: Clio, Twingo, Kangoo, Megane/Scenic, 1.2/1.6 D7F + K7M Petrol engine, Megane/Scenic, Kangoo 1.9D FBQ + F9Q Diesel engine (direct injection)

**C Fly wheel Locking device for:** Citroën: Xsara, Xantia 1.8/2.0XU7 JP/JB petrol engines, Xsara 1.8 16V XU7 JP4 twin cam shaft engines, Xantia 1.9D/TD XUD9BTF diesel engines, Xantia, XM2.1TD XUD 11BTE diesel engines, Peugeot: 406, 1.8/2.0 XU7 JP/JB Petrol engine, 406 1.8 16V XU7 JP4 Double cam shaft engines, 306, 405, 605 2.0 16V XU10J4 Double cam shaft engines, 406, 1.9D/TD XUD9BTF Diesel engines, 406, 605 2.1 TD XUD 11BTE Diesel engines

**D Fly wheel Locking device for:** Vauxhall/Opel: 1.2, 1.4, 1.6, 1.8, 2.0 OHC Petrol engines, 1.6D & 1.7, OHC Diesel engines, 1.5 & 1.7 OHE Diesel (Isuzu)-Engines

Please carry out an up-to-date cross reference test for the specific vehicle on [www.timingtools.de](http://www.timingtools.de)

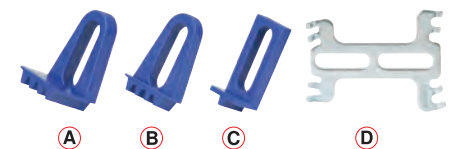

150.3025	4 pcs Universal fly wheel locking tool set	30



**FIAT**

**Alfa Romeo / Fiat / Lancia - Engine Timing Tool Set**

- For the professional engine repair
- For locking the crank shaft and cam shaft
- Suitable for pre-tensioning timing belt tensioner on the automatic pulley
- For changing the timing belt
- Very high degree of accuracy
- In durable steel storage case

**Application range:** universal usage on many Italian vehicles, in particular **Alfa Romeo, Fiat, Lancia** vehicles with 1.4 / 1.6 / 1.8 / 2.0 / Twinspark 1.2 / 1.4 / 1.6 / 1.8 16 V petrol engines 1.6 / 1.8 / 1.9D / TD / 2.0 / 2.1 12V / 2.4 diesel engines

**Please carry out an up-to-date cross reference test for the specific vehicle on [www.timingtools.de](http://www.timingtools.de)**

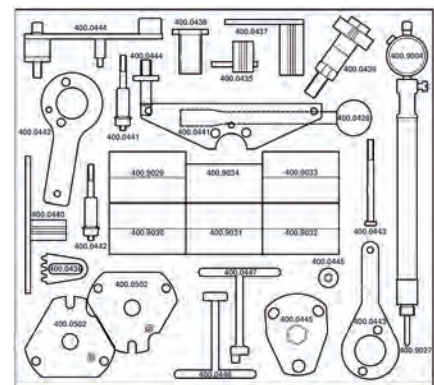
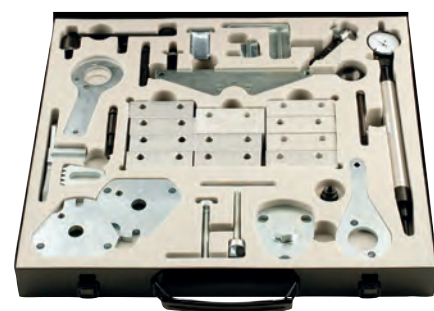

400.0425	34 pcs	Alfa Romeo / Fiat / Lancia - Engine Timing Tool Set	7.57
----------	--------	---	------

consists of:

400.0428	Tensioning tool - pry	170
400.0435	Flywheel locking tool	57
400.0436	Flywheel locking tool	135
400.0437	Flywheel locking tool	100
400.0438	Flywheel locking tool	51
400.0439	Flywheel locking tool	317
400.0440	Flywheel locking tool	136
400.0441	Crankshaft timing tool (2)	154
400.0442	Crankshaft timing tool (2)	154
400.0443	Crankshaft timing tool (3)	160
400.0444	Tensioning tool	240
400.0445	Camshaft locking tool (2)	530
400.0446	Balancer shaft belt tensioning tool	97
400.0447	Tensioning tool - pry	70
400.0502	Camshaft locking tool (2)	400
400.9004	Precision-dial indicator gauge 0 - 10 mm	78
400.9027	TDC determining pin Ø 5.0 mm / dial indicator bracket M14 x 1.25	288
400.9029	Camshaft locking tool (2)	276
400.9030	Camshaft locking tool (2)	251
400.9031	Camshaft locking tool (2)	272
400.9032	Camshaft locking tool (2)	269
400.9033	Camshaft locking tool (2)	276
400.9034	Crankshaft timing tool	178

**Alfa Romeo / Fiat / Lancia camshaft alignment tools**

- For the professional engine repair
- For locking the cam shaft wheels (TDC position)
- Secure hold thanks to optimal positioning
- Very high degree of accuracy

**Please carry out an up-to-date cross reference test for the specific vehicle on [www.timingtools.de](http://www.timingtools.de)**



X	Suitable for	
400.9031	2 Barchetta, Coupe 1.8 16v (> 1996)	272
400.9032	2 Brava, Bravo, Marea, Marea Weekend 1.8 16v (> 1995)	269
400.9033	2 Bravo, Marea, Marea Weekend, Coupe 2.0 20v (> 1994)	276
400.9034	1 Brava, Bravo 1.4 12v (> 1995) Lancia Ypsilon 1.4 12v (1996 - 1999)	178
400.9035	2 Lancia Kappa 2.0 2.4 20v (1994 - 1997), Stilo 2.4 20v (> 2001)	269
400.9036	2 Bravo, Marea, Marea Weekend, Coupe 2.0 20v (> 1994)	280

**Fiat / Ford / Opel /Suzuki - Engine Timing Tool Set**

- For the professional engine repair
- Especially for chain-driven engines
- For changing the steering chain
- Very high degree of accuracy
- In durable steel storage case

**Application range:** Fiat 1.3 JTD, Opel 1.3 CDTI, Ford 1.3 TDCi, Suzuki (engine code: Z13DT)

**Please carry out an up-to-date cross reference test for the specific vehicle on [www.timingtools.de](http://www.timingtools.de)**

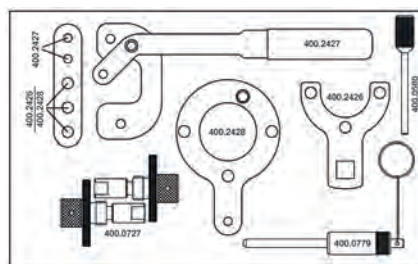
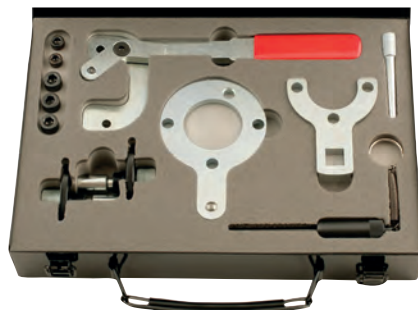
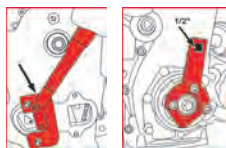

400.2425	12 pcs	Fiat / Ford / Opel /Suzuki - Engine Timing Tool Set	1.12
----------	--------	---	------

consists of:

400.0580	Crankshaft locking pin Ø 8,0 mm	30
400.0727	Camshaft locking tool (2)	130
400.0779	Crankshaft locking tool	80
400.2426	Crankshaft pulley flange holding tool (4)	88
400.2427	Timing chain tensioning tool (3)	171
400.2428	Flywheel timing position tool	398

**Fiat / Iveco - Engine Timing Tool Set**

- For the professional engine repair
- For locking the crank shaft and cam shaft
- For changing the timing belt
- Very high degree of accuracy

**Application range:** Fiat Ducato, Iveco Daily with 2.3 / 3.0 JTF engines (engine code: F1AE0481C, F1AE0481D, F1AE0481N, F1CE0481D)

**Please carry out an up-to-date cross reference test for the specific vehicle on [www.timingtools.de](http://www.timingtools.de)**

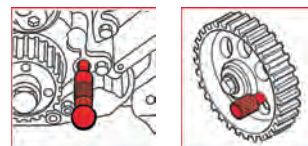

400.0400	5 pcs	Fiat / Iveco - Engine Timing Tool Set	518
----------	-------	---------------------------------------	-----

consists of:

400.0161	Crankshaft TDC locking pin	75
400.0165	Camshaft locking pin 5.0 mm	19
400.0401	Camshaft aligning tool (2)	70
400.0402	Crankshaft timing pin	200

**Fiat / GM / Opel / PSA / Renault - Engine Timing Tool Set**

- For the professional engine repair
- For changing the timing belt
- Very high degree of accuracy

**Application range:** Fiat, PSA, Renault, Opel vehicles with 2.5 / 2.8D engines

**Please carry out an up-to-date cross reference test for the specific vehicle on [www.timingtools.de](http://www.timingtools.de)**

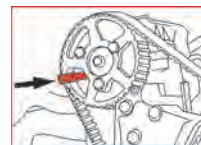

400.1775	4 pcs	Fiat / GM / Opel / PSA / Renault - Engine Timing Tool Set	143
----------	-------	---	-----

consists of:

400.0165	Camshaft locking pin 5.0 mm	19
400.0754	Camshaft locking pin	51
400.1388	Tensioner adjuster	41

### Citroën / Fiat - Engine Timing Tool Set

- For the professional engine repair
- For locking the cam shaft and the diesel pump
- Very high degree of accuracy

**Application range:** Citroën C15, Relais, Visa, Xantia, XM, Xsara, ZW, Fiat Ducato, Scudo, Ulysse

Please carry out an up-to-date cross reference test for the specific vehicle on [www.timingtools.de](http://www.timingtools.de)



400.1700	4 pcs	Citroën / Fiat - Engine Timing Tool Set	199
----------	-------	---	-----

consists of:

400.0285	Crankshaft locking pin Ø 8,0 mm	97
400.0286	Screw M8 x 35 mm (2)	16
400.0287	Screw M8 x 40,0 mm	18

### Alfa Romeo / Fiat - Engine Timing Tool Set

- For the professional engine repair
- For locking the cam shaft
- Very high degree of accuracy
- In durable steel storage case

**Application range:** Alfa Romeo Giulietta, Mito, Fiat 500, Brava, Bravo, Grande Punto, Marea, Marea Weekend, Marengo, Palio Weekend, Panda, Punto Classic, Ritmo, Stilo, Idea, Lancia Delta, Susa, Ypsilon with 1.2 16V engines

Please carry out an up-to-date cross reference test for the specific vehicle on [www.timingtools.de](http://www.timingtools.de)

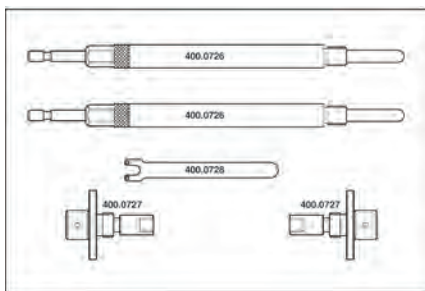

400.0725	5 pcs	Alfa Romeo / Fiat - Engine Timing Tool Set	989
----------	-------	--	-----

consists of:

400.0726	Piston height gauge (2)	250
400.0727	Camshaft locking tool (2)	130
400.0728	Tensioner adjusting tool	30

### Fiat - Engine Timing Tool Set

- For the professional engine repair
- For locking the cam shaft
- For changing the timing belt
- Very high degree of accuracy

**Application range:** Fiat Brava, Bravo with 1.4 12V engines (engine code: 182 A3.000 / 182 A5.000)

Please carry out an up-to-date cross reference test for the specific vehicle on [www.timingtools.de](http://www.timingtools.de)

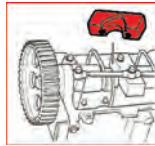

400.0525	4 pcs	Fiat - Engine Timing Tool Set	286
----------	-------	-------------------------------	-----

consists of:

400.0441	Crankshaft timing tool (2)	154
400.0448	Crankshaft locking pin	126
400.9034	Crankshaft timing tool	178



### Fiat - Engine Timing Tool Set

- For the professional engine repair
- For changing the timing belt
- Very high degree of accuracy

**Application range:** Fiat with 1.7D, TD engines (engine code: 184 B3.000 / 176 A3.000 / 176 A5.000)

Please carry out an up-to-date cross reference test for the specific vehicle on [www.timingtools.de](http://www.timingtools.de)

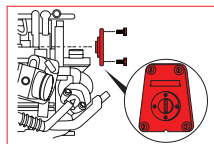

400.2000	4 pcs	Fiat - Engine Timing Tool Set	619
----------	-------	-------------------------------	-----

consists of:

400.0443	Crankshaft timing tool (3)	160
400.0451	Camshaft locking plate	530

### Fiat - Engine Timing Tool Set

- For the professional engine repair
- For locking the timing belt
- Very high degree of accuracy

**Application range:** Fiat Tipo, Tempra, Ducato (engine code: 149 B1.000 / 160 A6.000 / 160 A7.000 / 160 D1.000 / 230 A2.000 / 230 A3.000 / 230 A4.000 / 280 B1.000)

Please carry out an up-to-date cross reference test for the specific vehicle on [www.timingtools.de](http://www.timingtools.de)

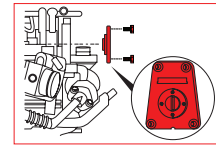

400.2025	4 pcs	Fiat - Engine Timing Tool Set	629
----------	-------	-------------------------------	-----

consists of:

400.0443	Crankshaft timing tool (3)	160
400.0452	Camshaft locking plate	530

### Fiat - Engine Timing Tool Set

- For the professional engine repair
- For changing the timing belt
- Very high degree of accuracy

**Application range:** Fiat Tipo, Tempra, Ducato with 1.9 TD engines

Please carry out an up-to-date cross reference test for the specific vehicle on [www.timingtools.de](http://www.timingtools.de)

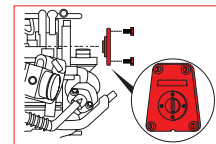

400.2050	4 pcs	Fiat - Engine Timing Tool Set	586
----------	-------	-------------------------------	-----

consists of:

400.0443	Crankshaft timing tool (3)	160
400.0453	Camshaft locking plate	530

**Fiat - Engine Timing Tool Set**

- For the professional engine repair
- For locking the double cam shaft
- Suitable for pre-tensioning the timing belt tension
- Very high degree of accuracy
- In durable steel storage case

**Application range:** Fiat Brava, Bravo, Marea, Marea weekend, Multipla, Palio (> 1995) with 1.6 engines. With the tensioning tool the connecting screws can be exchanged from M8 to M10 for one another.

Please carry out an up-to-date cross reference test for the specific vehicle on [www.timingtools.de](http://www.timingtools.de)

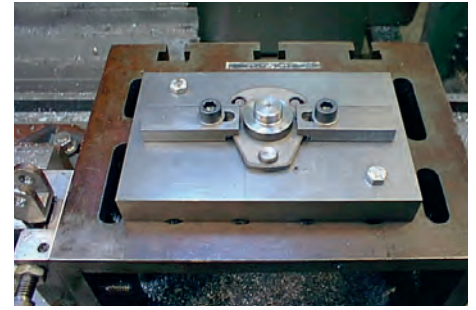

**Fiat / Ford - Engine Timing Tool Set**

- For the professional engine repair
- For locking the cam shaft
- For changing the timing belt
- Very high degree of accuracy
- In durable steel storage case

**Application range:** Fiat 500, Idea, Linea, Punto, Doblo, Panda, Ford Ka with 1.2 / 1.4 8V engines

Please carry out an up-to-date cross reference test for the specific vehicle on [www.timingtools.de](http://www.timingtools.de)

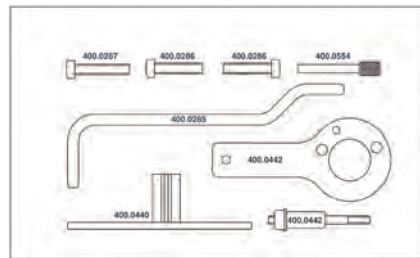

400.0550	8 pcs	Fiat / Peugeot - Engine Timing Tool Set	1.25
----------	-------	---	------

consists of:

400.0285	Crankshaft locking pin Ø 8,0 mm	97
400.0286	Screw M8 x 35 mm (2)	16
400.0287	Screw M8 x 40,0 mm	18
400.0440	Flywheel locking tool	136
400.0442	Crankshaft timing tool (2)	154
400.0554	Locking pin Ø 6,0 mm	19

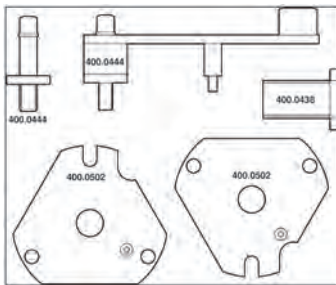
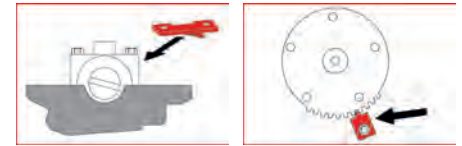

400.0500	5 pcs	Fiat - Engine Timing Tool Set	1.87
----------	-------	-------------------------------	------

consists of:

400.0438	Flywheel locking tool	51
400.0444	Tensioning tool	240
400.0502	Camshaft locking tool (2)	400

**Fiat - Engine Timing Tool Set**

- For the professional engine repair
- For locking the cam shaft
- For changing the timing belt
- Very high degree of accuracy

**Application range:** Fiat Punto, Tipo, Tempra, Ducato with 1.7 D/TD / 1.9 D / 1.9 TD diesel engines

Please carry out an up-to-date cross reference test for the specific vehicle on [www.timingtools.de](http://www.timingtools.de)



400.0450	4 pcs	Fiat - Engine Timing Tool Set	1.53
----------	-------	-------------------------------	------

consists of:

X		
400.0445	1	Camshaft locking tool (2)
400.0452	2	Camshaft locking plate

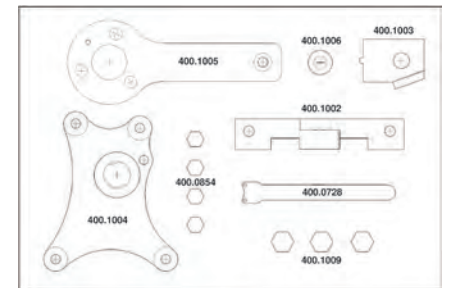

400.1000	13 pcs	Fiat / Ford - Engine Timing Tool Set	1.99
----------	--------	--------------------------------------	------

consists of:

X		
400.0728	1	Tensioner adjusting tool
400.0854	4	Screwn M6 x 30,0 mm
400.1002	1	Camshaft setting strap
400.1003	1	Camshaft locking tool M10
400.1004	1	Camshaft cover locking tool
400.1005	1	Crankshaft locking tool
400.1006	1	Screw M10 x 20,0 mm
400.1009	3	Locking screw M8 x 20,0 mm

**Fiat / Peugeot - Engine Timing Tool Set**

- For the professional engine repair
- For locking the crank shaft and cam shaft
- For changing the timing belt
- Very high degree of accuracy
- In durable steel storage case

**Application range:** Fiat Brava, Bravo, Marea, Marea (sic) and Peugeot with 1.9 D/TD engines (> 1996)

Please carry out an up-to-date cross reference test for the specific vehicle on [www.timingtools.de](http://www.timingtools.de)

### Alfa Romeo / Fiat - Engine Timing Tool Set

- For the professional engine repair
- For locking the crank shaft or cam shaft and injection pump
- Very high degree of accuracy
- In durable steel storage case

**Application range:** Fiat vehicles with 1.6 / 1.9 / 2.4 JTD Multijet diesel engines, Alfa Romeo with 2.0 JTD diesel engines (engine code: 939B3.000)

Please carry out an up-to-date cross reference test for the specific vehicle on [www.timingtools.de](http://www.timingtools.de)

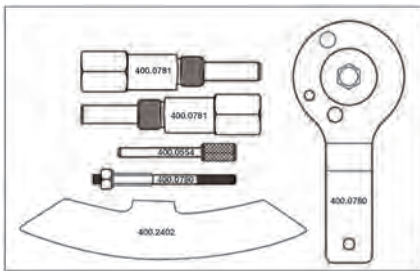
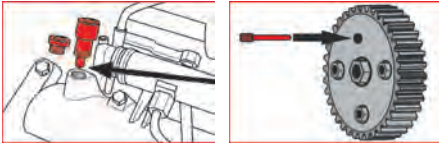

400.2400	7 pcs	Alfa Romeo / Fiat - Engine Timing Tool Set	1.46
----------	-------	--	------

consists of:

400.0554	Locking pin Ø 6.0 mm	19
400.0780	Crankshaft pulley setting tool (3)	260
400.0781	Camshaft timing pin set (2)	180
400.2402	Flywheel sprocket alignment tool	130

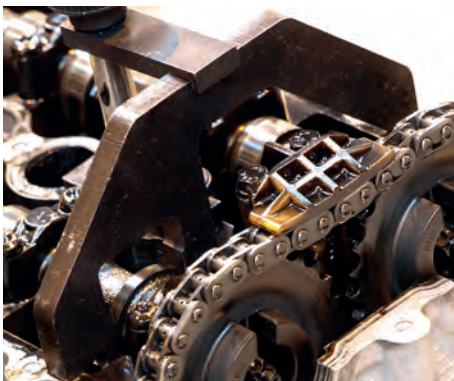

### Fiat / PSA - Engine Timing Tool Set

- For the professional engine repair
- For adjusting the valve controls
- For twin cam shaft systems with timing belt/chain combinations
- Very high degree of accuracy
- In durable steel storage case

**Application range:** Citroën and Fiat with 2.0 / 2.2 SOHC and DOHC engines (engine code: DW10 / DW12)

Please carry out an up-to-date cross reference test for the specific vehicle on [www.timingtools.de](http://www.timingtools.de)

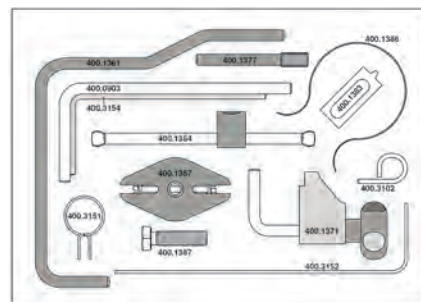
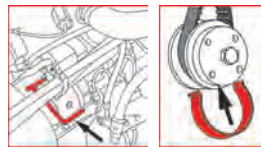

400.3150	12 pcs	Fiat / PSA - Engine Timing Tool Set	814
----------	--------	-------------------------------------	-----

consists of:

400.0903	Crankshaft locking pin	85
400.1361	Flywheel locking tool	146
400.1371	Belt retaining tool	99
400.1377	Tensioning locking pin	35
400.1383	Flywheel locking tool	30
400.1384	Tensioner adjuster	118
400.1386	Belt retaining tool	50
400.1387	Crankshaft pulley remover	153
400.3102	Tensioner locking pin	4
400.3151	Crankshaft pulley centralisation tool	2
400.3152	Tensioner locking pin	7
400.3154	Auxiliary drive belt tensioner locking pin Ø 4.0 mm	18

### Fiat / Iveco / PSA - Engine Timing Tool Set

- For the professional engine repair
- For locking the cam shaft or fly wheels
- Very high degree of accuracy
- In durable steel storage case

**Application range:** Fiat Ducato 2.8 TD, JTD, Iveco 2.8 D, TDI, Citroën Relay, Jumper, Peugeot Boxer, Boxer II (engine code: 8140,43 / 8140.43N / 8140.43S / 8140,63)

Please carry out an up-to-date cross reference test for the specific vehicle on [www.timingtools.de](http://www.timingtools.de)



400.3000	6 pcs	Fiat / Iveco / PSA - Engine Timing Tool Set	200
----------	-------	---	-----

consists of:

400.0165	Camshaft locking pin 5.0 mm	19
400.1377	Tensioning locking pin	35
400.1388	Tensioner adjuster	41
400.3001	Flywheel holding tool (2)	106

### Alfa Romeo / Fiat / Lancia - Engine Timing Tool Set

- For the professional engine repair
- Especially for chain-driven engines
- Very high degree of accuracy
- In durable steel storage case

**Application range:** Fiat Panda, Punto, 500, 500c, Alfa Romeo Mito, Lancia Ypsilon (engine code: 313A2.000)

Please carry out an up-to-date cross reference test for the specific vehicle on [www.timingtools.de](http://www.timingtools.de)

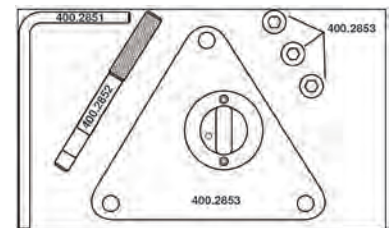

400.2850	6 pcs	Alfa Romeo / Fiat / Lancia - Engine Timing Tool Set	1.60
----------	-------	---	------

consists of:

400.2851	Flywheel locking tool	460
400.2852	Pulley locking pin	550
400.2853	Camshaft Locking Plate with screws	490

**Alfa Romeo / Fiat / Lancia - Engine Timing Tool Set**

- For the professional engine repair
- For locking the crank shaft
- For changing the timing belt
- Very high degree of accuracy
- In durable steel storage case

**Application range:** Alfa Romeo Mito, Giulietta MultiAir 105 , MultiAir Turbo 135 , 163 / 170 (2009-2013) Fiat Punto Evo, Punto, Bravo (2009-2013) Lancia Delta (2010-2013) - (engine code: 955A6.000 / 955A7.000 / 955A8.000 / 955A2.000 / 940A2.000)

Please carry out an up-to-date cross reference test for the specific vehicle on [www.timingtools.de](http://www.timingtools.de)

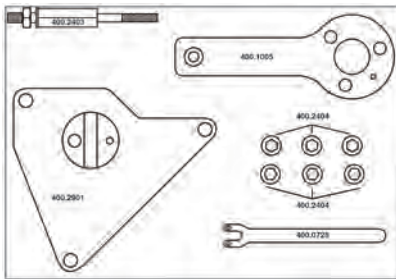
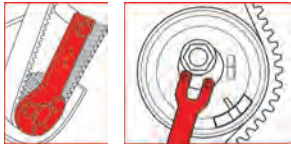

400.2900	10 pcs	Alfa Romeo / Fiat / Lancia - Engine Timing Tool Set	1,40
----------	--------	---	------

consists of:

Part No.	Description	Quantity
400.0728	Tensioner adjusting tool	30
400.1005	Crankshaft locking tool	7
400.2403	Stud assembly	33
400.2404	Socket head screw M8 x 20 mm	13
400.2901	Tensioner adjusting tool	504

**Fiat tension pulley wrench**

- Eccentric
- Suitable for the assembly and disassembly of the timing belt
- For adjusting the timing belt tension on the automatic pulley
- Not suitable for balancing belts
- With t-handle
- With plastic-coated handle
- Chrome vanadium

**Application range:** Fiat Brava, Bravo and Marea with 1.8L 16V engines >1996, Fiat Barchetta Coupe 1.8L 16V engine >1996

Please carry out an up-to-date cross reference test for the specific vehicle on [www.timingtools.de](http://www.timingtools.de)



Suitable for	Length mm	Weight kg	
150.1254	Fiat	95.0	80

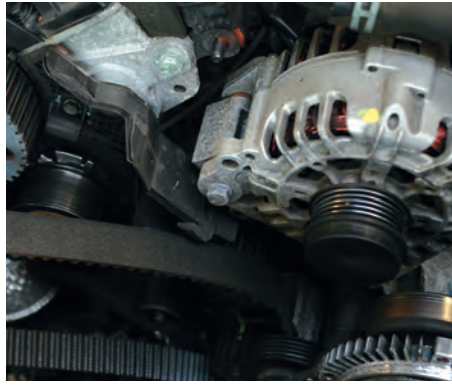

**Alfa Romeo / Fiat / Lancia - Engine Timing Tool Set**

- For the professional engine repair
- For changing the timing belt
- Very high degree of accuracy
- In durable steel storage case

**Application range:** Alfa Romeo Giulietta , MiTo Fiat 500, Brava, Bravo, Grande Punto, Marea, Marea Weekend, Marengo, Palio Weekend Panda, Punto, Punto Classic, Ritmo, Stilo, Idea Lancia Delta, Musa, Ypsilon

Please carry out an up-to-date cross reference test for the specific vehicle on [www.timingtools.de](http://www.timingtools.de)

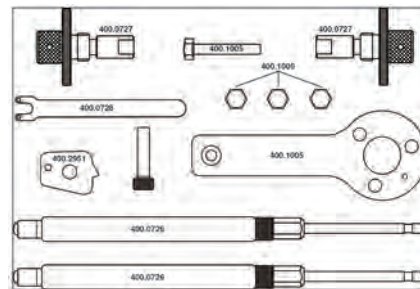

400.2950	12 pcs	Alfa Romeo / Fiat / Lancia - Engine Timing Tool Set	1,22
----------	--------	---	------

consists of:

Part No.	Description	Quantity
400.0726	Piston height gauge (2)	250
400.0727	Camshaft locking tool (2)	130
400.0728	Tensioner adjusting tool	30
400.1005	Crankshaft locking tool	7
400.2951	Camshaft pulley holding tool(2)	126

**Alfa Romeo / Fiat / GM / Opel - Engine Timing Tool Set**

- For the professional engine repair
- For changing the timing belt
- Very high degree of accuracy

**Application range:** Chevrolet Cruze, Orlando with 1.4 / 1.6 / 1.8 engines, Opel Astra-G, Astra-H, Corsa-D, Insignia, Meriva, Signum, Vectra-C, Zafira-B, Fiat Croma, Alfa Romeo 159 (engine code: Z / A / 939A4.000)

Please carry out an up-to-date cross reference test for the specific vehicle on [www.timingtools.de](http://www.timingtools.de)

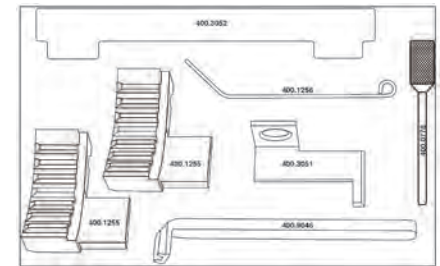
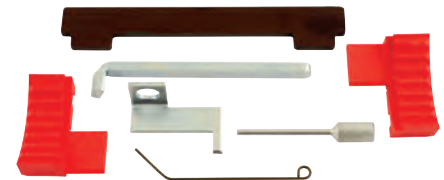
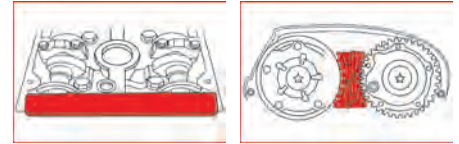

400.3050	7 pcs	Alfa Romeo / Fiat / GM / Opel - Engine Timing Tool Set	424
----------	-------	--	-----

consists of:

Part No.	Description	Quantity
400.0778	Locking pin	20
400.1255	Camshaft locking tool (2)	56
400.1256	Tensioner locking pin	3
400.3051	Flywheel holding tool	32
400.3052	Camshaft Locking Bar	148
400.9046	Flywheel locking tool	80



**FORD**

**Ford / VAG - Engine Timing Tool Set**

- For the professional engine repair
- For locking the cam shaft
- For changing the timing belt or the chain
- Very high degree of accuracy
- In durable steel storage case

**Application range:** Ford vehicles with TDDi / TDCi and Duratorq engines and Ford Galaxy with similar engines to Volkswagen

Please carry out an up-to-date cross reference test for the specific vehicle on [www.timingtools.de](http://www.timingtools.de)

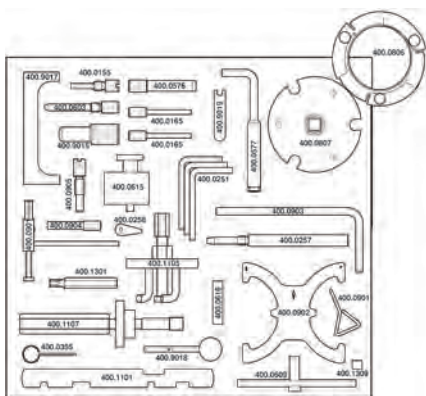
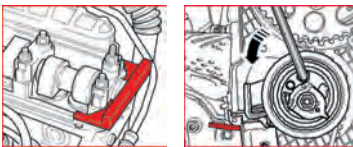

				1
400.1300	31 pcs	Ford / VAG - Engine Timing Tool Set	6.68	

**consists of:**

			1
400.0155	Crankshaft timing pin	240	
400.0165	Camshaft locking pin 5.0 mm	19	
400.0251	Injection pump locking pin Ø 6.0 mm	30	
400.0257	Crankshaft TDC locking pin	124	
400.0258	Shim tool (2)	3	
400.0355	Tensioner pushrod retension pin	1	
400.0576	Flywheel locking pin	64	
400.0577	Flywheel locking tool	124	
400.0603	Crankshaft timing pin	51	
400.0609	Flywheel locking tool	308	

**consists of:**

			1
400.0615	Crankshaft pulley setting tool	190	
400.0616	Flywheel locking adaptor	74	
400.0806	Locking tool	45	
400.0807	Pump cover locking tool	2	
400.0901	Tensioning locking pin	4	
400.0902	Camshaft locking tool	384	
400.0903	Crankshaft locking pin	85	
400.0904	Camshaft/injection pump locking pin	26	
400.0905	Crankshaft locking pin	33	
400.1101	Camshaft setting strap	140	
400.1105	Camshaft sprocket puller	552	
400.1106	Fuel sprocket remover	80	
400.1107	Chain cover alignment tool	497	
400.1301	TX T45 bit	31	
400.1309	Flywheel locking adaptor	13	
400.9015	Injection pump locking pin Ø 15.4 mm	126	
400.9017	Camshaft setting strap	120	
400.9018	Injection pump locking pin Ø 6.0 mm	20	
400.9019	Tensioner locking tool	20	

**Ford pulley wheel counter hold wrench**

- For the professional engine repair
- Simple assembly and disassembly of the crank shaft pulley wheel
- Special profile opposite to the screw head
- Long lever
- With plastic-coated handle
- Chrome vanadium
- Very high degree of accuracy

**Application range:** Ford Mondeo, Transit from 2001 onwards with 2.0 / 2.4 / 3.2 Duratorq TDCi engines

Please carry out an up-to-date cross reference test for the specific vehicle on [www.timingtools.de](http://www.timingtools.de)



		Suitable for	Length mm	1
400.9003		Ford	600.0	1.55

**Ford fan hub wrench**

- For the professional engine repair
- Simple assembly and disassembly of the Visco coupling rotor
- Makes it possible to secure the pulley wheel of the water pump and at the same time release the heating filter
- Special steel
- Very high degree of accuracy

**Application range:** Ford Transit (2001 - 2006)



		Suitable for	Pin key mm	1
400.9014		Ford	69.0	133

**Ford / Mazda - Engine Timing Tool Set**

- For the professional engine repair
- For locking the crank shaft or cam shaft
- For changing the timing belt
- Very high degree of accuracy
- In durable steel storage case

**Application range:** Ford and Mazda vehicles with 1.2 / 1.3 / 1.4 / 1.6 SOHC and 1.6 / 1.8 / 2.0 16V petrol engines, 1.8 / 1.9 D/TD / 1.9 TDi / 2.5 TDi diesel engines and Zetec engines

Please carry out an up-to-date cross reference test for the specific vehicle on [www.timingtools.de](http://www.timingtools.de)

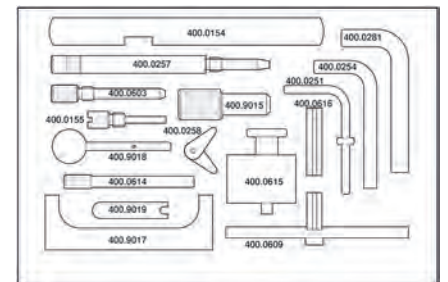
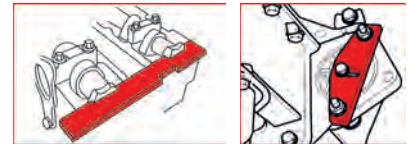

				1
400.0600	18 pcs	Ford / Mazda - Engine Timing Tool Set	1.48	

**consists of:**

			1
400.0154	Camshaft setting strap	150	
400.9018	Injection pump locking pin Ø 6.0 mm	20	
400.0155	Crankshaft timing pin	240	
400.0251	Injection pump locking pin Ø 6.0 mm	30	
400.0254	Locking pin Ø 9.5 mm	60	
400.0257	Crankshaft TDC locking pin	124	
400.0258	Shim tool (2)	3	
400.0281	Timing pin Ø 12,7 mm	569	
400.0603	Crankshaft timing pin	51	
400.0609	Flywheel locking tool	308	
400.0614	Locking pin, Ø 8.25 mm	40	
400.0615	Crankshaft pulley setting tool	190	
400.0616	Flywheel locking adaptor	74	
400.9015	Injection pump locking pin Ø 15.4 mm	126	
400.9019	Tensioner locking tool	20	
400.9017	Camshaft setting strap	120	

**Fiat / Ford / Opel /Suzuki - Engine Timing Tool Set**

- For the professional engine repair
- Especially for chain-driven engines
- For changing the steering chain
- Very high degree of accuracy
- In durable steel storage case

**Application range:** Fiat 1.3 JTD, Opel 1.3 CDTI, Ford 1.3 TDCi, Suzuki (engine code: Z13DT)

Please carry out an up-to-date cross reference test for the specific vehicle on [www.timingtools.de](http://www.timingtools.de)

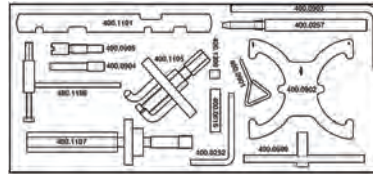
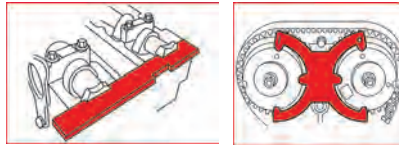
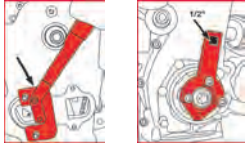

400.1200	14 pcs	Ford - Engine Timing Tool Set	2.26
----------	--------	-------------------------------	------

consists of:

400.0252	Camshaft locking pin 6.0 mm	26
400.1107	Chain cover alignment tool	497
400.1106	Fuel sprocket remover	80
400.1105	Camshaft sprocket puller	552
400.1101	Camshaft setting strap	140
400.0905	Crankshaft locking pin	33
400.0904	Camshaft/injection pump locking pin	26
400.0903	Crankshaft locking pin	85
400.0902	Camshaft locking tool	384
400.0901	Tensioning locking pin	4
400.0257	Crankshaft TDC locking pin	124
400.0609	Flywheel locking tool	308
400.0616	Flywheel locking adaptor	74
400.1309	Flywheel locking adaptor	13

**Ford - Engine Timing Tool Set**

- For the professional engine repair
- For locking the cam shaft
- For changing the cam belt or the chain
- Very high degree of accuracy
- In durable steel storage case

**Application range:** Ford vehicles with 1.8 TDDi / TDCi engines

Please carry out an up-to-date cross reference test for the specific vehicle on [www.timingtools.de](http://www.timingtools.de)

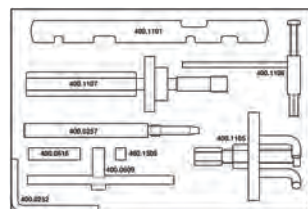

400.1100	9 pcs	Ford - Engine Timing Tool Set	2.00
----------	-------	-------------------------------	------

consists of:

400.0252	Camshaft locking pin 6.0 mm	26
400.1107	Chain cover alignment tool	497
400.1106	Fuel sprocket remover	80
400.1105	Camshaft sprocket puller	552
400.1101	Camshaft setting strap	140
400.0257	Crankshaft TDC locking pin	124
400.0609	Flywheel locking tool	308
400.0616	Flywheel locking adaptor	74
400.1309	Flywheel locking adaptor	13

**Ford - Engine Timing Tool Set**

- For the professional engine repair
- For locking the crank shaft or cam shaft
- For changing the timing belt
- Very high degree of accuracy
- In durable steel storage case

**Application range:** Ford vehicles with 1.6 / 1.8 / 2.5 diesel engines

Please carry out an up-to-date cross reference test for the specific vehicle on [www.timingtools.de](http://www.timingtools.de)

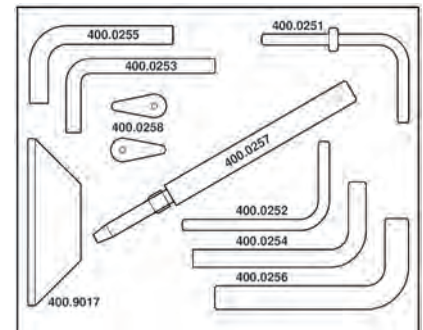
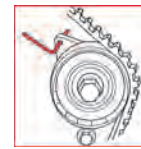

400.0250	10 pcs	Ford - Engine Timing Tool Set	590
----------	--------	-------------------------------	-----

consists of:

400.0251	Injection pump locking pin Ø 6.0 mm	30
400.0252	Camshaft locking pin 6.0 mm	26
400.0253	Locking pin Ø 8.0 mm	41
400.0254	Locking pin Ø 9.5 mm	60
400.0255	Locking pin Ø 10.0 mm	60
400.0256	Locking pin Ø 12.0 mm	120
400.0257	Crankshaft TDC locking pin	124
400.0258	Shim tool (2)	3
400.9017	Camshaft setting strap	120

400.2425	12 pcs	Fiat / Ford / Opel /Suzuki - Engine Timing Tool Set	1.12
----------	--------	---	------

consists of:

400.0580	Crankshaft locking pin Ø 8,0 mm	30
400.0727	Camshaft locking tool (2)	130
400.0779	Crankshaft locking tool	80
400.2426	Crankshaft pulley flange holding tool (4)	88
400.2427	Timing chain tensioning tool (3)	171
400.2428	Flywheel timing position tool	398

**Ford - Engine Timing Tool Set**

- For the professional engine repair
- Expansion set for use in connection with 400.0600
- For locking the crank shaft or cam shaft
- For changing the timing belt
- Very high degree of accuracy
- In durable steel storage case

**Application range:** Ford Focus, C-Max with 1.6 Ti VCT engines, Fiesta, Fusion with 1.4 / 1.6 TDCi engines, Mondeo, S-Max, Transit Connect, Tourneo Connect with 1.8 TDDi / TDCi and 2.0 TDCi engines (engine code: HXADA)

Please carry out an up-to-date cross reference test for the specific vehicle on [www.timingtools.de](http://www.timingtools.de)

### Ford - Engine Timing Tool Set

- For the professional engine repair
- For locking the cam shaft
- For changing the timing belt
- Very high degree of accuracy

**Application range:** Ford Focus, C-Max with 1.6 Ti-VCT and 2.0 TDCi engines (2003-2007) (engine code: HXDA / G6DA / G6DB / G6DC)

Please carry out an up-to-date cross reference test for the specific vehicle on [www.timingtools.de](http://www.timingtools.de)

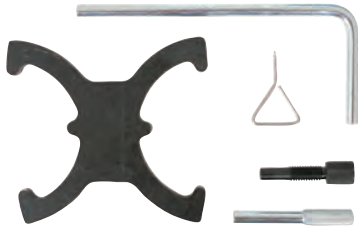
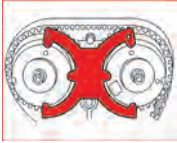

400.0900	5 pcs	Ford - Engine Timing Tool Set	1.16

consists of:

400.0901	Tensioning locking pin	4	
400.0902	Camshaft locking tool	384	
400.0903	Crankshaft locking pin	85	
400.0904	Camshaft/injection pump locking pin	26	
400.0905	Crankshaft locking pin	33	

### Ford / Volvo - Engine Timing Tool Set

- For the professional engine repair
- For locking the crank shaft and cam shaft
- For changing the timing belt
- Very high degree of accuracy

**Application range:** Ford B-Max (2012), C-Max (2010), Focus (2011), Galaxy (2010), Grand-C-Max (2010-2011), Mondeo (2010), S-Max (2010), Volvo S60 (2001), S80 (2010-2011), V60 (2011), V70 (2010-2011) with 1.6 Ti-VCT, 2.0 TDCI engines (engine code: IQJA / JQDA / JQDB / JQDA / JTDB / JQDA / JQDB / JTWA / JTWB / JQDA / JTDA / JTDB / JTBA / JTBB / B4164T3 / B4164T / B4164T2)

Please carry out an up-to-date cross reference test for the specific vehicle on [www.timingtools.de](http://www.timingtools.de)



400.4125	4 pcs	Ford / Volvo - Engine Timing Tool Set	498

consists of:

400.0902	Camshaft locking tool	384	
400.0905	Crankshaft locking pin	33	
400.4126	Crank shaft discs adjustment tool	50	
400.4127	Pin for chain tensioner	10	

### VAG - Engine Timing Tool Set

- For the professional engine repair
- For TDI pump injection engines
- For changing the timing belt
- Secure hold for changing the timing belt or engine repairs

**Application range:** universal usage for many VAG group vehicles, in particular Audi A3, A4, A6, Skoda Octavia 2, Fabia, Volkswagen Golf, Golf Plus, Jetta, Touran, Lupo, Fox, Bora, Beetle, Caddy, Sharan, Passat, Seat Leon, Toledo, Altea, Alhambra with 1.4 / 1.9 / 2.0 TDi engines

Please carry out an up-to-date cross reference test for the specific vehicle on [www.timingtools.de](http://www.timingtools.de)

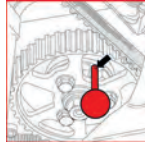

400.2700	7 pcs	VAG - Engine Timing Tool Set	455

consists of:

400.0615	Crankshaft pulley setting tool	190	
400.0901	Tensioning locking pin	4	
400.1415	Crankshaft pulley setting tool	192	
400.1425	Tensioning locking pin	11	
400.9018	Injection pump locking pin Ø 6.0 mm	20	

### Ford / Mazda - Engine Timing Tool Set

- For the professional engine repair
- For locking the crank shaft and cam shaft
- For changing the timing belt
- Very high degree of accuracy

**Application range:** Ford Mondeo with 1.8 engines and Mazda 3, 5, 6, CV7, MX5, MPV, Tribute with Zetec/Duratec or DISI engines

Please carry out an up-to-date cross reference test for the specific vehicle on [www.timingtools.de](http://www.timingtools.de)

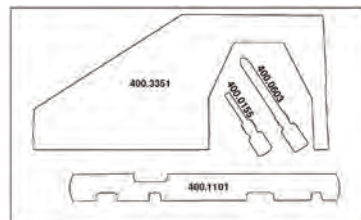
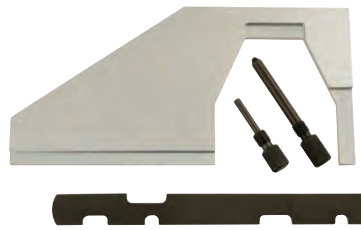
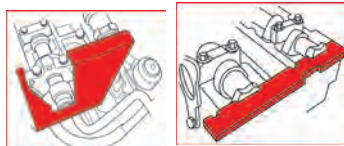

400.3350	4 pcs	Ford / Mazda - Engine Timing Tool Set	1.05

consists of:

400.0155	Crankshaft timing pin	240	
400.0603	Crankshaft timing pin	51	
400.1101	Camshaft setting strap	140	
400.3351	Camshaft Locking Plate	780	

### Ford / Volvo - Engine Timing Tool Set

- For the professional engine repair
- For locking the crank shaft or cam shaft
- For changing the timing belt
- Very high degree of accuracy

**Application range:** Ford, Volvo with petrol engines

Please carry out an up-to-date cross reference test for the specific vehicle on [www.timingtools.de](http://www.timingtools.de)

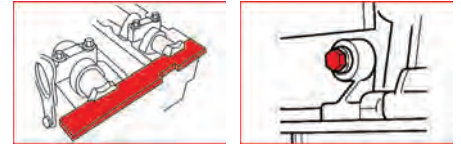

400.1525	4 pcs	Ford / Volvo - Engine Timing Tool Set	291

consists of:

400.0155	Crankshaft timing pin	240	
400.0603	Crankshaft timing pin	51	
400.0905	Crankshaft locking pin	33	
400.1101	Camshaft setting strap	140	

### Ford / Mazda - Engine Timing Tool Set

- For the professional engine repair
- For locking the crank shaft
- Especially for Ford 16V vehicles
- Very high degree of accuracy

**Application range:** Ford Fiesta 1.25 / 1.4 engines, Puma 1.4 / 1.7 engines, Mondeo 1.6 / 1.8 / 2.0 engines, Mazda 121 with 1.25 engines

Please carry out an up-to-date cross reference test for the specific vehicle on [www.timingtools.de](http://www.timingtools.de)

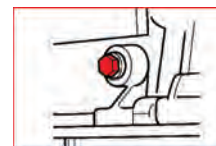

400.0175	2 pcs	Ford / Mazda - Engine Timing Tool Set	180

consists of:

400.0154	Camshaft setting strap	150	
400.0155	Crankshaft timing pin	240	



**Ford - Engine Timing Tool Set**

- For the professional engine repair
- Expansion set for Ford Duratorque engines
- For locking the crank shaft and cam shaft
- For changing the timing belt or the chain
- Very high degree of accuracy
- In durable steel storage case

**Application range:** Ford Duratorq-engines Fiesta and Fusion with 1.4 D/TDCi engines with timing belt, Mondeo, Transit 2.0 D/Di with timing chain, Puma, Transit with 2.4 D/Di/TDDi with timing chain, Mondeo with 2.0 / 2.2 TDCi with timing chain, Transit (2000-2008) with 2.0 / 2.2 TDCi, 2.4 TDi with timing chain

Please carry out an up-to-date cross reference test for the specific vehicle on [www.timingtools.de](http://www.timingtools.de)

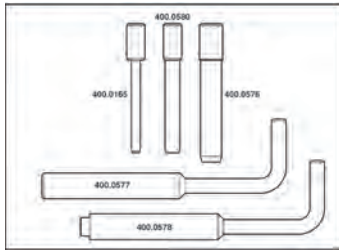
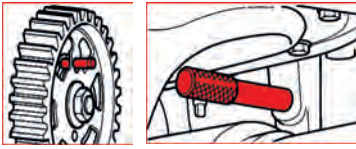

400.0575	5 pcs	Ford - Engine Timing Tool Set	319
----------	-------	-------------------------------	-----

consists of:

	X		
400.0165	2	Camshaft locking pin 5,0 mm	19
400.0576	1	Flywheel locking pin	64
400.0577	1	Flywheel locking tool	124
400.0578	1	Flywheel locking pin	122
400.0580	1	Crankshaft locking pin Ø 8,0 mm	30

**Ford - Engine Timing Tool Set**

- For the professional engine repair
- For locking the cam shaft
- For changing the timing belt or the chain
- Very high degree of accuracy
- In durable steel storage case

**Application range:** Ford vehicles with chain-driven 2.0 / 2.4 Duratorq engines (2002-2010), also for the belt change on 1.4 / 1.6 engines. Contains tool for the removal and exchanging of fuel injection pumps on Ford 2.0 / 2.4 Duratorq Di/TDDi and 2.2 / 2.4 Duratorq TDCi diesel engines

Please carry out an up-to-date test for the specific vehicle on [www.timingtool.de](http://www.timingtool.de)

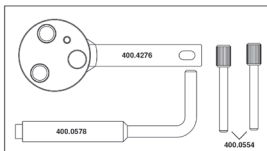

400.4275	4 pcs	Ford - Engine Timing Tool Set	415
----------	-------	-------------------------------	-----

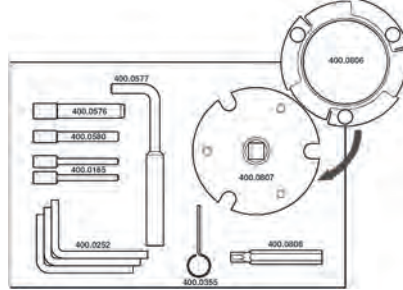
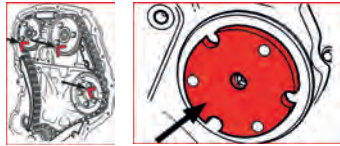

400.0800	11 pcs	Ford - Engine Timing Tool Set	956
----------	--------	-------------------------------	-----

consists of:

	X		
400.0165	2	Camshaft locking pin 5.0 mm	19
400.0252	2	Camshaft locking pin 6.0 mm	26
400.0355	1	Tensioner pushrod retension pin	1
400.0576	1	Flywheel locking pin	64
400.0577	1	Flywheel locking tool	124
400.0580	1	Crankshaft locking pin Ø 8,0 mm	30
400.0806	1	Locking tool	45
400.0807	1	Pump cover locking tool	2
400.0808	1	Key for TX45	31

**Ford - Engine Timing Tool Set**

- For the professional engine repair
- For locking the cam shaft
- For changing the timing belt
- Very high degree of accuracy

**Application range:** Ford Transit 2.2 TDCi engines (> 2006), including Econetic and HDT engines

Please carry out an up-to-date cross reference test for the specific vehicle on [www.timingtools.de](http://www.timingtools.de)

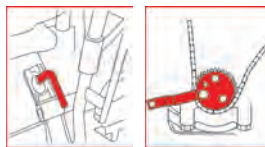

consists of:

	X		
400.0554	2	Locking pin Ø 6.0 mm	19
400.0578	1	Flywheel locking pin	122
400.4276	1	Crank shaft chain wheel holding tool	200

**Ford - Engine Timing Tool Set**

- For the professional engine repair
- For locking the crank shaft and cam shaft
- For changing the timing belt
- Very high degree of accuracy
- In durable steel storage case

**Application range:** Ford Galaxy (2010), Mondeo (2010), S Max (2010), Focus (2011) with 2.0 SCTI Ecoboost / Ti-VCT engines (engine code: TNWA / TNWB / TNBA / TPWA / MGDA / XQDA)

Please carry out an up-to-date cross reference test for the specific vehicle on [www.timingtools.de](http://www.timingtools.de)

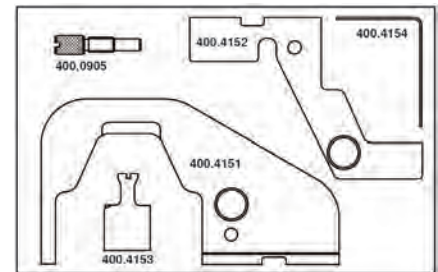
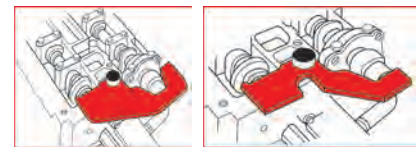

400.4150	5 pcs	Ford - Engine Timing Tool Set	2.18
----------	-------	-------------------------------	------

consists of:

	X		
400.0905	1	Crankshaft locking pin	33
400.4151	1	Cam shaft alignment plate	700
400.4152	1	Cam shaft alignment plate	250
400.4153	1	Pin for aligning the cam shaft	30
400.4154	1	Tension pin 2.0 mm	20

### Ford / Land Rover / PSA / Volvo - Engine Timing Tool Set

- For the professional engine repair
- For changing the timing belt
- Very high degree of accuracy

**Application range:** Ford, Land Rover, PSA, Volvo vehicles with 2,0 / 2,2 DOHC Common-Rail Diesel engines

Please carry out an up-to-date cross reference test for the specific vehicle on [www.timingtools.de](http://www.timingtools.de)

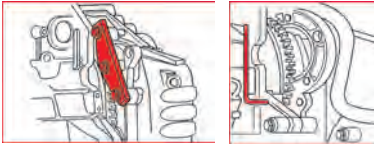

400.1625	3 pcs	Ford / Land Rover / PSA / Volvo - Engine Timing Tool Set	473
----------	-------	--	-----

consists of:

400.0580	Crankshaft locking pin Ø 8,0 mm	30
400.0609	Flywheel locking tool	308
400.0903	Crankshaft locking pin	85

### Fiat / Ford - Engine Timing Tool Set

- For the professional engine repair
- For locking the cam shaft
- For changing the timing belt
- Very high degree of accuracy
- In durable steel storage case

**Application range:** Fiat 500, Idea, Linea, Punto, Doblo, Panda, Ford Ka with 1.2 / 1.4 8V engines

Please carry out an up-to-date cross reference test for the specific vehicle on [www.timingtools.de](http://www.timingtools.de)

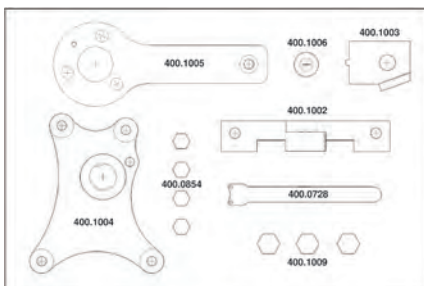
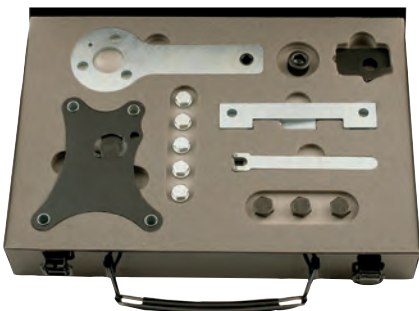

400.1000	13 pcs	Fiat / Ford - Engine Timing Tool Set	1.99
----------	--------	--------------------------------------	------

consists of:

X	g	
400.0728	1 Tensioner adjusting tool	30
400.0854	4 Screwn M6 x 30,0 mm	9
400.1002	1 Camshaft setting strap	80
400.1003	1 Camshaft locking tool M10	86
400.1004	1 Camshaft cover locking tool	300
400.1005	1 Crankshaft locking tool	7
400.1006	1 Screw M10 x 20,0 mm	22
400.1009	3 Locking screw M8 x 20,0 mm	11

### GM

### GM / Opel - Engine Timing Tool Set

- For the professional engine repair
- For locking the cam shaft or chain tensioner
- Very high degree of accuracy

**Application range:** Opel Astra-G, Vectra-B, Vectra-C, Signum, Zafira-A (engine code: Z22SE / Z22YH)

Please carry out an up-to-date cross reference test for the specific vehicle on [www.timingtools.de](http://www.timingtools.de)



400.2325	2 pcs	GM / Opel - Engine Timing Tool Set	787
----------	-------	------------------------------------	-----

consists of:

400.2326	Camshaft locking tool	786
400.2327	Timing chain tensioner locking pin	1

### GM / Isuzu / Opel / Saab - Engine Timing Tool Set

- For the professional engine repair
- Especially for chain-driven vehicles
- For locking dual cam shafts
- Very high degree of accuracy
- In durable steel storage case

**Application range:** Opel Agila, Astra-G, Astra-H, Combo-C, Corsa-B, Corsa-C, Corsa-D, Meriva-A, Tigra-B (1993-2010) with 1.0 12V / 1.2 16V engines (engine code: X10XE / Z10XE / Z10 XEP / X12XE / Z12XE / Z12 XEP / Z14XEL / Z14XEA) and similar Isuzu- and Saab-engines

Please carry out an up-to-date cross reference test for the specific vehicle on [www.timingtools.de](http://www.timingtools.de)

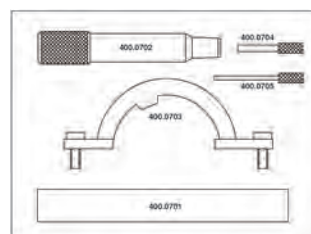
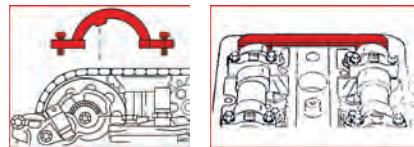

400.0700	5 pcs	GM / Isuzu / Opel / Saab - Engine Timing Tool Set	446
----------	-------	---	-----

consists of:

400.0701	Camshaft timing tool	404
400.0702	Flywheel TDC locking pin	205
400.0703	Camshaft position (CMP) sensor disc setting tool	102
400.0704	Tensioner retaining pin	4
400.0705	Tensioner retaining pin	5

### GM / Opel - Engine Timing Tool Set

- For the professional engine repair
- Expansion set
- For engines without thread attachment bore holes
- Very high degree of accuracy

**Application range:** Opel Astra-F, Astra-G, Cavalier, Vectra-A (1997 - 2001) with 1.7 engines (engine code: 17DR / X17DT / DTL)

Please carry out an up-to-date cross reference test for the specific vehicle on [www.timingtools.de](http://www.timingtools.de)



400.0650	5 pcs	GM / Opel - Engine Timing Tool Set	380
----------	-------	------------------------------------	-----

consists of:

400.0651	Camshaft locking tool (3)	169
400.0652	Flywheel TDC indicator	80
400.0653	Flywheel locking pin	79

### Alfa Romeo / Fiat / GM / Opel - Engine Timing Tool Set

- For the professional engine repair
- For changing the timing belt
- Very high degree of accuracy

**Application range:** Chevrolet Cruze, Orlando with 1.4 / 1.6 / 1.8 engines, Opel Astra-G, Astra-H, Corsa-D, Insignia, Meriva, Signum, Vectra-C, Zafira-B, Fiat Croma, Alfa Romeo 159 (engine code: Z / A / 939A.000)

Please carry out an up-to-date cross reference test for the specific vehicle on [www.timingtools.de](http://www.timingtools.de)

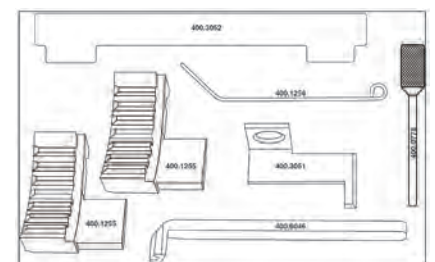
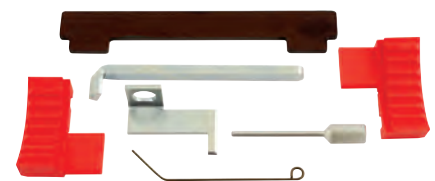
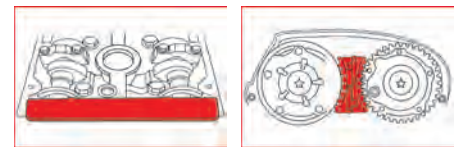

400.3050	7 pcs	Alfa Romeo / Fiat / GM / Opel - Engine Timing Tool Set	424
----------	-------	--	-----

consists of:

400.0778	Locking pin	20
400.1255	Camshaft locking tool (2)	56
400.1256	Tensioner locking pin	3
400.3051	Flywheel holding tool	32
400.3052	Camshaft Locking Bar	148
400.9046	Flywheel locking tool	80

**GM / Opel Fly wheel locking tool**

- For locking the fly wheels
- For easily attaching to one of the small fixing pins next to the fly wheel
- Special steel

**Application range:** for all Opel and GM 4 and 6 cylinder CIH, 24V and OHC engines

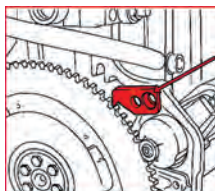

400.9045	GM / Opel Fly wheel locking tool	80
----------	----------------------------------	----

**HONDA**

**Honda - Engine Timing Tool Set**

- For the professional engine repair
- For locking the belt drive on twin-cam, dual-cam shaft engines
- Very high degree of accuracy

**Application range:** Honda Civic, Accord, Prelude, Shuttle, Odyssey (engine code: F18A3 / F18B2 / F18B4 / F20AF / F20B3 / F20B5 / F20B6 / F20B7 / F20Z1 / F20Z2 / F22Z2 / F22B5 / F22B8 / F22A2 / H22A5 / H22A7 / H22A8 / F23A7 / F23Z5 / H23A2 / H23A3 / J30A1 / B16A2 / F18A3)

**Please carry out an up-to-date cross reference test for the specific vehicle on [www.timingtools.de](http://www.timingtools.de)**



400.2525	6 pcs	Honda - Engine Timing Tool Set	194
----------	-------	--------------------------------	-----

consists of:

400.0165	Camshaft locking pin 5.0 mm	19
400.0753	Locking screw M6 x 30.0 mm	10
400.2526	Tensioner locking pin tool	60
400.2527	Balance shaft locking tool	46

**HYUNDAI**

**Hyundai / Mitsubishi / Volvo - Engine Timing Tool Set**

- For the professional engine repair
- For actuating belt tensioners
- Very high degree of accuracy

**Application range:** universal usage on many Hyundai, Mitsubishi, Volvo vehicles

**Please carry out an up-to-date cross reference test for the specific vehicle on [www.timingtools.de](http://www.timingtools.de)**



400.0075	2 pcs	Hyundai / Mitsubishi / Volvo - Engine Timing Tool Set	131
----------	-------	---	-----

consists of:

400.0076	Tensioning locking pin	630
400.0077	Belt tensioner wrench	210

**Hyundai cam shaft locking tool**

- For the professional engine repair
- Clamping device for a secure hold to change the timing belt
- Special plastic
- Very high degree of accuracy

**Application range:** Hyundai Sontana from 1999 onwards

**Please carry out an up-to-date test for the specific vehicle on [www.timingtool.de](http://www.timingtool.de)**

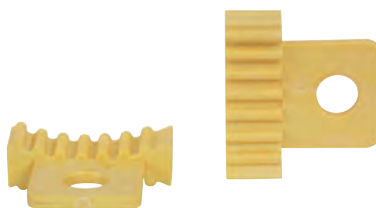

150.3058	1	Hyundai cam shaft locking tool	30
----------	---	--------------------------------	----



**ISUZU**

**Isuzu / GM / Opel / Saab - Engine Timing Tool Set**

- For the professional engine repair
- For changing the timing belt
- Very high degree of accuracy
- In durable steel storage case

**Application range:** Opel Agila, Ascona, Astra-F, Astra-G, Corsa-B, Corsa-C, Frontera, Kadett-E, Midi, Monterey, Omega-B, Sintra, Vectra-A, Vectra-B, Vectra-C, Zafira and similar Isuzu and Saab vehicles

**Please carry out an up-to-date cross reference test for the specific vehicle on [www.timingtools.de](http://www.timingtools.de)**

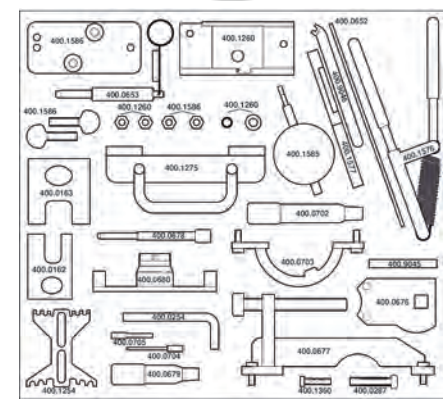
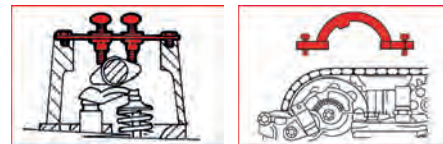

400.1575	33 pcs	Isuzu / GM / Opel / Saab - Engine Timing Tool Set	3.91
----------	--------	---	------

consists of:

400.0162	Opel / Saab Camshaft locking tool	186
400.0163	Camshaft locking tool	143
400.0254	Locking pin Ø 9.5 mm	60
400.0287	Screw M8 x 40,0 mm	18
400.0652	Flywheel TDC indicator	80
400.0653	Flywheel locking pin	79
400.0676	Camshaft turning tool	7
400.0677	Bracket for timing adjustment wrench	111
400.0678	Injection pump locking pin	41
400.0679	Flywheel TDC locking pin	160
400.0680	Camshaft locking tool	322
400.0702	Flywheel TDC locking pin	205
400.0703	Camshaft position (CMP) sensor disc setting tool	102
400.0704	Tensioner retaining pin	4
400.0705	Tensioner retaining pin	5
400.1254	Flywheel locking tool	23
400.1260	Camshaft locking tool (5)	9
400.1275	Camshaft setting strap (TDC)	404
400.1360	Flywheel locking tool	82
400.1576	Belt tensioner adjuster	297
400.1577	Camshaft setting strap	99
400.1585	Dial gauge Ø 51 (10 x 0.01 mm)	154
400.1586	Camshaft position locking tool (5)	170
400.9045	Flywheel locking tool	80
400.9046	Flywheel locking tool	80

### GM / Isuzu / Opel / Saab - Engine Timing Tool Set

- For the professional engine repair
- For locking the cam shaft
- For changing the timing belt
- Very high degree of accuracy
- In durable steel storage case

**Application range:** Opel Agila, Ascona, Astra-F, Astra-G, Astramax, Belmont, Cavalier, Corsa-B, Corsa-C, Frontera, Kadett-E, Midi, Monterey, Omega-B, Sintra, Vectra-A, Vectra-B, Vectra-C, Zafira with petrol and diesel engines including Eco-Tec engines and similar **Isuzu** and **Saab** engines

Please carry out an up-to-date cross reference test for the specific vehicle on [www.timingtools.de](http://www.timingtools.de)

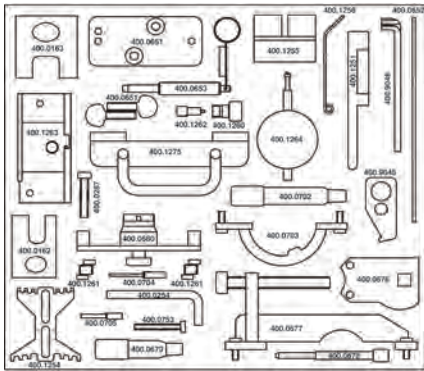
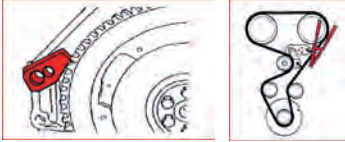

			9
400.1250	36 pcs	GM / Isuzu / Opel / Saab - Engine Timing Tool Set	6.18

consists of:

			9
X			
400.0162	1	Opel / Saab Camshaft locking tool	186
400.0163	1	Camshaft locking tool	143
400.0254	1	Locking pin Ø 9.5 mm	60
400.0287	1	Screw M8 x 40,0 mm	18
400.0651	1	Camshaft locking tool (3)	169
400.0652	1	Flywheel TDC indicator	80
400.0653	1	Flywheel locking pin	79
400.0676	1	Camshaft turning tool	7
400.0677	1	Bracket for timing adjustment wrench	111
400.0678	1	Injection pump locking pin	41
400.0679	1	Flywheel TDC locking pin	160
400.0680	1	Camshaft locking tool	322
400.0702	1	Flywheel TDC locking pin	205
400.0703	1	Camshaft position (CMP) sensor disc setting tool	102
400.0704	1	Tensioner retaining pin	4
400.0705	1	Tensioner retaining pin	5
400.0753	1	Locking screw M6 x 30,0 mm	10
400.1251	1	Camshaft locking tool	118
400.1254	1	Flywheel locking tool	23
400.1255	1	Camshaft locking tool (2)	56

consists of:

			9
X			
400.1256	1	Tensioner locking pin	3
400.1260	1	Camshaft locking tool (5)	9
400.1261	4	Locking screw M6 x 10,0 mm	4
400.1262	1	Special tip	10
400.1263	1	Mounting bracket assy	330
400.1264	1	Dial gauge Ø 51 (10 x 0,01 mm)	161
400.1275	1	Camshaft setting strap (TDC)	404
400.9045	1	Flywheel locking tool	80
400.9046	1	Flywheel locking tool	80

### GM / Isuzu / Opel / Saab - Engine Timing Tool Set

- For the professional engine repair
- Especially for chain-driven vehicles
- For locking dual cam shafts
- Very high degree of accuracy
- In durable steel storage case

**Application range:** Opel Agila, Astra-G, Astra-H, Combo-C, Corsa-B, Corsa-C, Corsa-D, Meriva-A, Tigra-B (1993-2010) with 1.0 12V / 1.2 16V engines (engine code: X10XE / Z10XE / Z10 XEP / X12XE / Z12XE / Z12 XEP / Z14XEL / Z14XEA) and similar **Isuzu**- and **Saab**-engines

Please carry out an up-to-date cross reference test for the specific vehicle on [www.timingtools.de](http://www.timingtools.de)

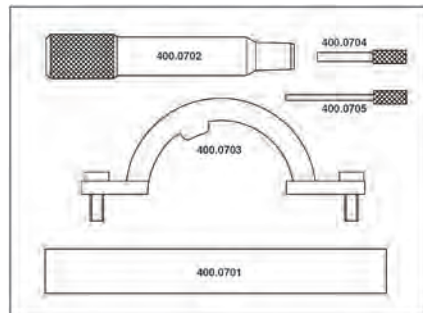
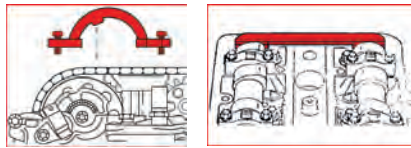

			9
400.0700	5 pcs	GM / Isuzu / Opel / Saab - Engine Timing Tool Set	446

consists of:

			9
X			
400.0701		Camshaft timing tool	404
400.0702		Flywheel TDC locking pin	205
400.0703		Camshaft position (CMP) sensor disc setting tool	102
400.0704		Tensioner retaining pin	4
400.0705		Tensioner retaining pin	5

### GM / Isuzu / Opel / Saab - Camshaft locking tool

- For the professional engine repair
- Clamping device for a secure hold to change the timing belt
- Aluminium
- Very high degree of accuracy

**Application range:** Opel Tigra 2004 - 2008 (engine code: Z18XE) with 1.8 engines, Frontera, Frontera-B and Sintra-A, Omega-B 1995 - 2004 (engine code: X22SE, X33XE, YEESE, Y22XE Z22XE) with 2.2 16V engines. **Saab** 9-3 1996 - 2005 with 1.8 engines (engine code: Z18XE) and similar **Isuzu** and **Saab** engines

Please carry out an up-to-date cross reference test for the specific vehicle on [www.timingtools.de](http://www.timingtools.de)



			9
X			
400.0162	1	GM / Isuzu / Opel / Saab - Camshaft locking tool	186

### IVECO

#### Diesel fuel pump timing set

- For the professional engine repair
- Precise measuring device for the upper entry hole
- For resetting the injection time on diesel engines
- Very high degree of accuracy
- In durable steel storage case

**Application range:** Alfa Romeo, Audi, BMW, Daihatsu, Fiat, Ford, Isuzu, Iveco, Lancia, Land Rover, Mazda, Mitsubishi, Nissan, PSA (XUD), Renault, Rover, Volkswagen vehicles with Bosch, EP/VE Rotary, Niki, Nippon Denso, CAV RotoDiesel, Top injection fuel pumps

Please carry out an up-to-date cross reference test for the specific vehicle on [www.timingtools.de](http://www.timingtools.de)

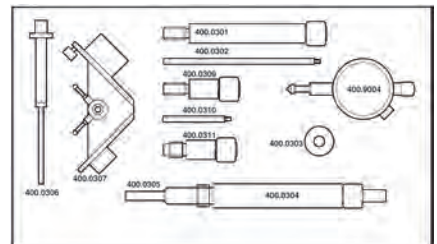

			9
400.0300	11 pcs	Diesel fuel pump timing set	710

consists of:

			9
X			
400.0301		Dial gauge adapter M8 (Bosch), long	71
400.0302		Dial gauge extension, long 99 mm	9
400.0303		Converter M8 x M12	12

consists of:

400.0304	TDC determining pin / dial indicator bracket M14 x 2.0 mm	135
400.0305	Extension	460
400.0306	Dial gauge probe for Lukas-CAV-Roto	17
400.0307	Dial gauge assy for Lukas-CAV-Roto	125
400.0309	Dial gauge adapter M8 (Bosch) short, silver	37
400.0310	Dial gauge extension short	4
400.0311	Dial gauge adapter M10 (Bosch) short, black	40
400.9004	Precision-dial indicator gauge 0 - 10 mm	78

**Diesel fuel pump timing set**

- For the professional engine repair
- Precise measuring device
- Very high degree of accuracy
- In durable steel storage case

**Application range:** Alfa Romeo, Audi, BMW, Daihatsu, Fiat, Ford, Isuzu, Iveco, Lancia, Land Rover, Mazda, Mitsubishi, Nissan, Renault, Rover and Volkswagen vehicles with Bosch, Kikki, Nippon Denso injection pumps with threads of M8, M10 and M12, with new M10 Adapter in particular for Ford Transit

Please carry out an up-to-date cross reference test for the specific vehicle on [www.timingtools.de](http://www.timingtools.de)

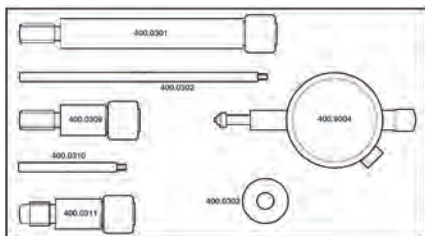
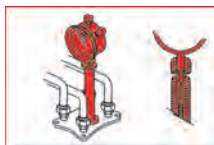

400.0325	7 pcs Diesel fuel pump timing set	301
----------	-----------------------------------	-----

consists of:

400.0301	Dial gauge adapter M8 (Bosch), long	71
400.0302	Dial gauge extension, long 99 mm	9
400.0303	Convertor M8 x M12	12
400.9004	Precision-dial indicator gauge 0 - 10 mm	78
400.0309	Dial gauge adapter M8 (Bosch) short, silver	37
400.0310	Dial gauge extension short	4
400.0311	Dial gauge adapter M10 (Bosch) short, black	40

**Fiat / Iveco - Engine Timing Tool Set**

- For the professional engine repair
- For locking the crank shaft and cam shaft
- For changing the timing belt
- Very high degree of accuracy

**Application range:** Fiat Ducato, Iveco Daily with 2.3 / 3.0 JTF engines (engine code: F1AE0481C, F1AE0481D, F1AE0481N, F1CE0481D)

Please carry out an up-to-date cross reference test for the specific vehicle on [www.timingtools.de](http://www.timingtools.de)

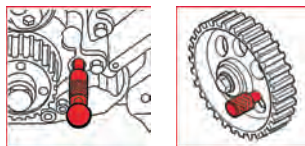

400.0400	5 pcs Fiat / Iveco - Engine Timing Tool Set	518
----------	---	-----

consists of:

400.0161	Crankshaft TDC locking pin	75
400.0165	Camshaft locking pin 5.0 mm	19
400.0401	Camshaft aligning tool (2)	70
400.0402	Crankshaft timing pin	200

**Fiat / Iveco / PSA - Engine Timing Tool Set**

- For the professional engine repair
- For locking the cam shaft or fly wheels
- Very high degree of accuracy
- In durable steel storage case

**Application range:** Fiat Ducato 2.8 TD, JTD, Iveco 2.8 D, TDI, Citroën Relay, Jumper, Peugeot Boxer, Boxer II (engine code: 8140.43 / 8140.43N / 8140.43S / 8140.63)

Please carry out an up-to-date cross reference test for the specific vehicle on [www.timingtools.de](http://www.timingtools.de)



400.3000	6 pcs Fiat / Iveco / PSA - Engine Timing Tool Set	200
----------	---	-----

consists of:

400.0165	Camshaft locking pin 5.0 mm	19
400.1377	Tensioning locking pin	35
400.1388	Tensioner adjuster	41
400.3001	Flywheel holding tool (2)	106

**JAGUAR**

**Land Rover / Jaguar - Engine Timing Tool Set**

- For the professional engine repair
- For locking the cam shaft
- For changing the timing belt
- Very high degree of accuracy
- In durable steel storage case

**Application range:** Land Rover Discovery, Range Rover Sport with 2.7 TDV6 engines and Jaguar S Type with TDV6 engines, including fly wheel locking tool for automatic and manual transmissions (engine code: 276D T)

Please carry out an up-to-date cross reference test for the specific vehicle on [www.timingtools.de](http://www.timingtools.de)

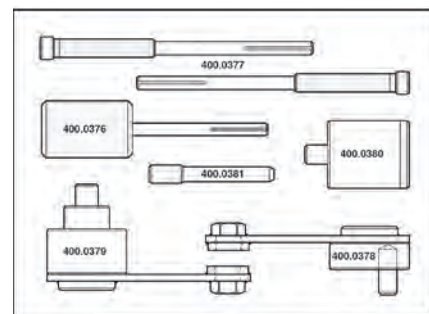

400.0375	7 pcs Land Rover / Jaguar - Engine Timing Tool Set	912
----------	--	-----

consists of:

400.0376	Camshaft sprocket locking tool	165
400.0377	Camshaft sprocket locking pin (2)	68
400.0378	Flywheel locking tool - automatic tensioner	195
400.0379	Flywheel locking tool - manual tensioner	268
400.0380	Flywheel locking tool	222
400.0381	Coolant Pump tensioning locking pin	30



### Jaguar / Land Rover - Engine Timing Tool Set

- For the professional engine repair
- Especially for chain-driven vehicles
- Very high degree of accuracy
- In durable steel storage case

**Application range:** Jaguar and Daimler V8, Sport 4.0 / 3.2 / 4.2 / 3.5, S-Type, XJ8, XJR, XK8, XKR (< 2010) with 4.0 / 4.2 V8 engines (engine code: BC / LB / LC / GC / AC / KC / DC / CC / CE / NC / EG / PA / HB / 1B / RB / SB / TB / 3B / PC / NB), Land Rover Discovery3, Range Rover 4.2, Supercharged 4.4 (engine code: 4PN / 428PS)

Please carry out an up-to-date cross reference test for the specific vehicle on [www.timingtools.de](http://www.timingtools.de)

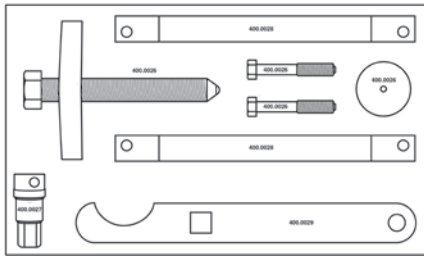
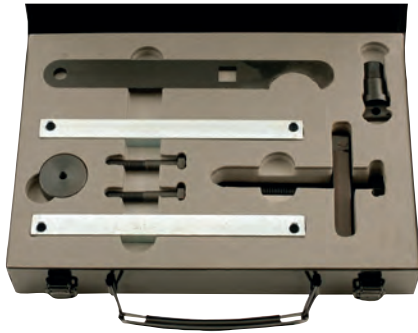
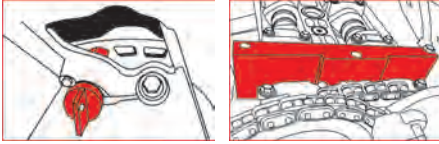

400.0025	9 pcs	Jaguar / Land Rover - Engine Timing Tool Set	3.51
----------	-------	--	------

consists of:

400.0026	Crankshaft pulley puller (4)	530
400.0027	Crankshaft locking tool	70
400.0028	Camshaft locking tool (2)	740
400.0029	Timing chain wrench	200

### KIA

#### KIA cam shaft locking tool

- For the professional engine repair
- Clamping device for a secure hold to change the timing belt
- Special plastic
- Very high degree of accuracy

**Application range:** Kia Clarus 1.6 - 1.8 from 1997 onwards

Please carry out an up-to-date cross reference test for the specific vehicle on [www.timingtools.de](http://www.timingtools.de)

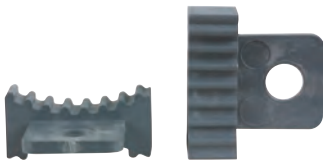

150.3055	1	KIA cam shaft locking tool	40
----------	---	----------------------------	----

### KIA cam shaft locking tool

- For the professional engine repair
- Clamping device for a secure hold to change the timing belt
- Special plastic
- Very high degree of accuracy

**Application range:** Kia Carnival Diesel from 1998 onwards

Please carry out an up-to-date cross reference test for the specific vehicle on [www.timingtools.de](http://www.timingtools.de)

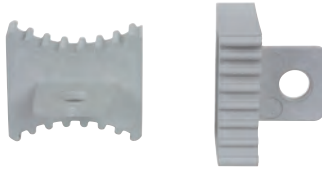

X			
150.3056	1	KIA cam shaft locking tool	80

### LANCIA

#### Alfa Romeo / Fiat / Lancia - Engine Timing Tool Set

- For the professional engine repair
- For locking the crank shaft and cam shaft
- Suitable for pre-tensioning timing belt tensioner on the automatic pulley
- For changing the timing belt
- Very high degree of accuracy
- In durable steel storage case

**Application range:** universal usage on many Italian vehicles, in particular Alfa Romeo, Fiat, Lancia vehicles with 1.4 / 1.6 / 1.8 / 2.0 / Twinspark 1.2 / 1.4 / 1.6 / 1.8 16 V petrol engines 1.6 / 1.8 / 1.9D / TD / 2.0 / 2.1 12V / 2.4 diesel engines

Please carry out an up-to-date cross reference test for the specific vehicle on [www.timingtools.de](http://www.timingtools.de)

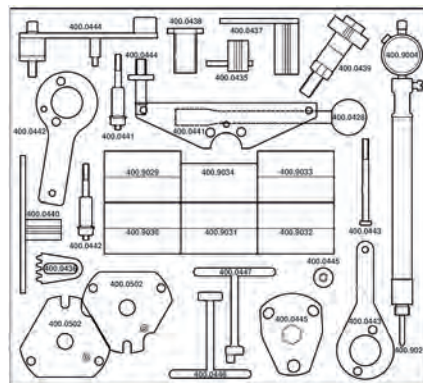
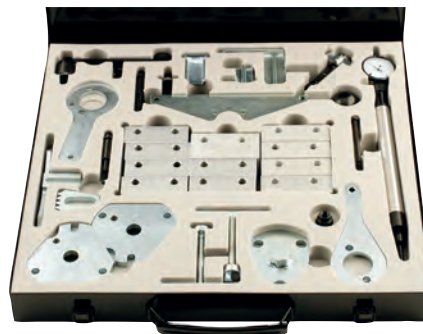
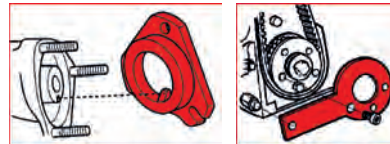

400.0425	34 pcs	Alfa Romeo / Fiat / Lancia - Engine Timing Tool Set	7.57
----------	--------	---	------

consists of:

400.0428	Tensioning tool - pry	170
400.0435	Flywheel locking tool	57
400.0436	Flywheel locking tool	135
400.0437	Flywheel locking tool	100
400.0438	Flywheel locking tool	51
400.0439	Flywheel locking tool	317
400.0440	Flywheel locking tool	136
400.0441	Crankshaft timing tool (2)	154
400.0442	Crankshaft timing tool (2)	154
400.0443	Crankshaft timing tool (3)	160
400.0444	Tensioning tool	240
400.0445	Camshaft locking tool (2)	530
400.0446	Balancer shaft belt tensioning tool	97
400.0447	Tensioning tool - pry	70
400.0502	Camshaft locking tool (2)	400
400.9004	Precision-dial indicator gauge 0 - 10 mm	78
400.9027	TDC determining pin Ø 5,0 mm / dial indicator bracket M14 x 1.25	288
400.9029	Camshaft locking tool (2)	276
400.9030	Camshaft locking tool (2)	251
400.9031	Camshaft locking tool (2)	272
400.9032	Camshaft locking tool (2)	269
400.9033	Camshaft locking tool (2)	276
400.9034	Crankshaft timing tool	178

#### Alfa Romeo / Fiat / Lancia - Engine Timing Tool Set

- For the professional engine repair
- Especially for chain-driven engines
- Very high degree of accuracy
- In durable steel storage case

**Application range:** Fiat Panda, Punto, 500, 500c, Alfa Romeo Mito, Lancia Ypsilon (engine code: 313A2.000)

Please carry out an up-to-date cross reference test for the specific vehicle on [www.timingtools.de](http://www.timingtools.de)

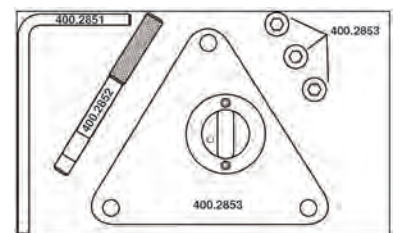

400.2850	6 pcs	Alfa Romeo / Fiat / Lancia - Engine Timing Tool Set	1.60
----------	-------	---	------

consists of:

400.2851	Flywheel locking tool	460	
400.2852	Pulley locking pin	550	
400.2853	Camshaft Locking Plate with screws	490	

**Alfa Romeo / Fiat / Lancia - Engine Timing Tool Set**

- For the professional engine repair
- For locking the crank shaft
- For changing the timing belt
- Very high degree of accuracy
- In durable steel storage case

**Application range:** Alfa Romeo Mito, Giulietta MultiAir 105, MultiAir Turbo 135, 163 / 170 (2009-2013) Fiat Punto Evo, Punto, Bravo (2009-2013) Lancia Delta (2010-2013) - (engine code: 955A6.000 / 955A7.000 / 955A8.000 / 955A2.000 / 940A2.000)

Please carry out an up-to-date cross reference test for the specific vehicle on [www.timingtools.de](http://www.timingtools.de)

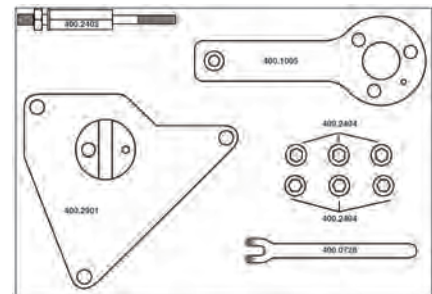
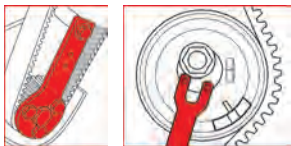

400.2900	10 pcs Alfa Romeo / Fiat / Lancia - Engine Timing Tool Set	1.40	

consists of:

400.0728	Tensioner adjusting tool	30	
400.1005	Crankshaft locking tool	7	
400.2403	Stud assembly	33	
400.2404	Socket head screw M8 x 20 mm	13	
400.2901	Tensioner adjusting tool	504	

**Alfa Romeo / Fiat / Lancia - Engine Timing Tool Set**

- For the professional engine repair
- For changing the timing belt
- Very high degree of accuracy
- In durable steel storage case

**Application range:** Alfa Romeo Giulietta, MiTo Fiat 500, Brava, Bravo, Grande Punto, Marea, Marea Weekend, Marengo, Palio Weekend Panda, Punto, Punto Classic, Ritmo, Stilo, Idea Lancia Delta, Musa, Ypsilon

Please carry out an up-to-date cross reference test for the specific vehicle on [www.timingtools.de](http://www.timingtools.de)

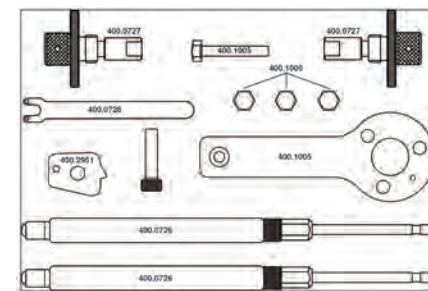

400.2950	12 pcs Alfa Romeo / Fiat / Lancia - Engine Timing Tool Set	1.22	

consists of:

	X		
400.0726	1 Piston height gauge (2)	250	
400.0727	1 Camshaft locking tool (2)	130	
400.0728	1 Tensioner adjusting tool	30	
400.1005	5 Crankshaft locking tool	7	
400.2951	1 Camshaft pulley holding tool(2)	126	

**Alfa Romeo / Fiat / Lancia camshaft alignment tools**

- For the professional engine repair
- For locking the cam shaft wheels (TDC position)
- Secure hold thanks to optimal positioning
- Very high degree of accuracy

Please carry out an up-to-date cross reference test for the specific vehicle on [www.timingtools.de](http://www.timingtools.de)



	X	Suitable for	
400.9034	1	Brava, Bravo 1.4 12v (> 1995) Lancia Ypsilon 1.4 12v (1996 - 1999)	178
400.9035	2	Lancia Kappa 2.0 2.4 20v (1994 - 1997), Stilo 2.4 20v (> 2001)	269

**LAND ROVER**

**Land Rover / MG / Rover - Engine Timing Tool Set**

- For the professional engine repair
- For locking the cam shaft of all KV6 variants
- For changing the timing belt
- Very high degree of accuracy
- In durable steel storage case

**Application range:** Rover 825, 45, 75, Land Rover Freelander 2.5, MG ZS, ZT, ZT-T 160, 180, 190 with 2.0 / 2.5 V6 Quad-Cam petrol engines

Please carry out an up-to-date cross reference test for the specific vehicle on [www.timingtools.de](http://www.timingtools.de)

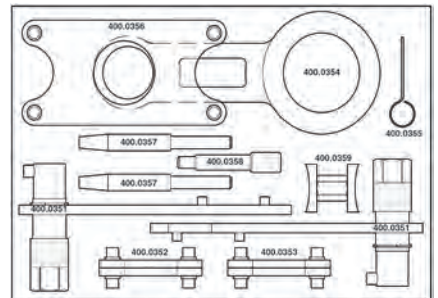

400.0350	12 pcs Land Rover / MG / Rover - Engine Timing Tool Set	3.62	

consists of:

400.0351	Crankshaft timing tool (2)	500	
400.0352	Camshaft locking adaptor set, 2.0 L (2)	76	
400.0353	Camshaft locking adaptor set, 2.5 L (2)	80	
400.0354	Rear camshaft sprocket setting tool	480	
400.0355	Tensioner pushrod retension pin	1	
400.0356	Rear camshaft sprocket setting tool	390	
400.0357	Rear camshaft sprocket guide pin	50	
400.0358	Crankshaft locking pin	40	
400.0359	Rear cam sprocket spreader	80	

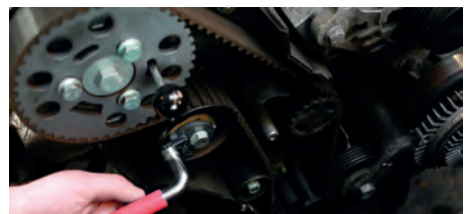

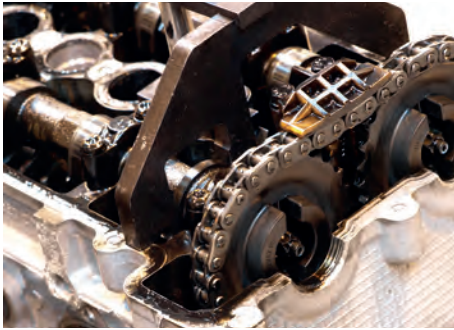

### Land Rover / Jaguar - Engine Timing Tool Set

- For the professional engine repair
- For locking the cam shaft
- For changing the timing belt
- Very high degree of accuracy
- In durable steel storage case

**Application range:** Land Rover Discovery, Range Rover Sport with 2.7 TDV6 engines and Jaguar S Type with TDV6 engines, including fly wheel locking tool for automatic and manual transmissions (engine code: 276D T)

Please carry out an up-to-date cross reference test for the specific vehicle on [www.timingtools.de](http://www.timingtools.de)

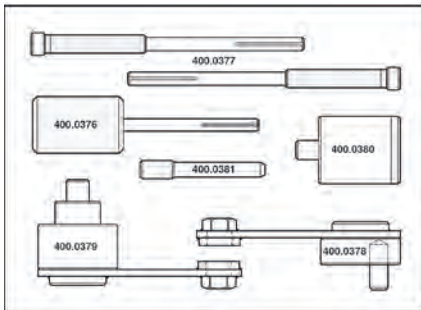

400.0375	7 pcs	Land Rover / Jaguar - Engine Timing Tool Set	912

consists of:

400.0376	Camshaft sprocket locking tool	165	
400.0377	Camshaft sprocket locking pin (2)	68	
400.0378	Flywheel locking tool - automatic tensioner	195	
400.0379	Flywheel locking tool - manual tensioner	268	
400.0380	Flywheel locking tool	222	
400.0381	Coolant Pump tensioning locking pin	30	

### BMW / Land Rover / Rover - Engine Timing Tool Set

- For the professional engine repair
- For locking the crank shaft or cam shaft
- For changing the timing belt or the timing chain
- Very high degree of accuracy
- In durable steel storage case

**Application range:** BMW 1, 3, 5, X3, Land Rover Freelander, Rover 75 (engine code: M47)

Please carry out an up-to-date cross reference test for the specific vehicle on [www.timingtools.de](http://www.timingtools.de)

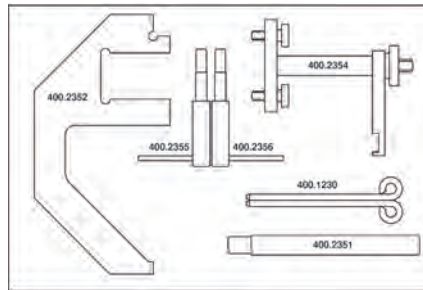

400.2350	7 pcs	BMW / Land Rover / Rover - Engine Timing Tool Set	1.03

consists of:

400.1230	Tensioning locking pin (2)	14	
400.2351	Crankshaft TDC locking pin	108	
400.2352	Camshaft locking tool	461	
400.2354	Camshaft locking holding tool	240	
400.2355	Crankshaft timing tool	52	
400.2356	Crankshaft timing tool	55	

### Land Rover / Rover - Engine Timing Tool Set

- For the professional engine repair
- For locking the crank shaft or fly disc
- For changing the timing belt
- Very high degree of accuracy

**Application range:** Land Rover Freelander 1.8, Rover Metro, 214, 216, 218 16V, 414, 416 16V, 216, 416 GTI, Rover Diesel 218, 418

Please carry out an up-to-date cross reference test for the specific vehicle on [www.timingtools.de](http://www.timingtools.de)



400.2600	3 pcs	Land Rover / Rover - Engine Timing Tool Set	1.50

consists of:

400.2601	Flywheel locking tool	470	
400.2602	Flywheel locking tool	480	
400.2603	Flywheel locking tool	460	

### Jaguar / Land Rover - Engine Timing Tool Set

- For the professional engine repair
- Especially for chain-driven vehicles
- Very high degree of accuracy
- In durable steel storage case

**Application range:** Jaguar and Daimler V8, Sport 4.0 / 3.2 / 4.2 / 3.5, S-Type, XJ8, XJR, XK8, XKR (< 2010) with 4.0 / 4.2 V8 engines (engine code: BC / LB / LC / GC / AC / KC / DC / CC / CE / NC / EG / PA / HB / 1B / RB / SB / TB / 3B / PC / NB), Land Rover Discovery3, Range Rover 4.2, Supercharged 4.4 (engine code: 4PN / 428PS)

Please carry out an up-to-date cross reference test for the specific vehicle on [www.timingtools.de](http://www.timingtools.de)

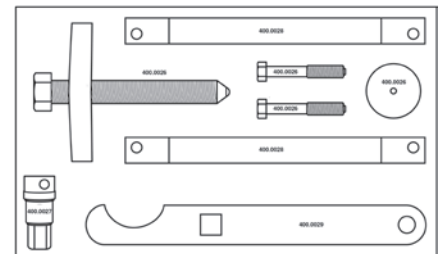
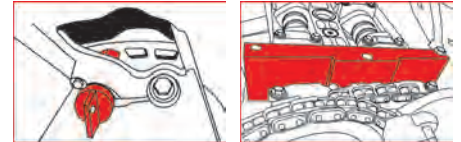

400.0025	9 pcs	Jaguar / Land Rover - Engine Timing Tool Set	3.51

consists of:

400.0026	Crankshaft pulley puller (4)	530	
400.0027	Crankshaft locking tool	70	
400.0028	Camshaft locking tool (2)	740	
400.0029	Timing chain wrench	200	



**Ford / Land Rover / PSA / Volvo - Engine Timing Tool Set**

- For the professional engine repair
- For changing the timing belt
- Very high degree of accuracy

**Application range:** Ford, Land Rover, PSA, Volvo vehicles with 2,0 / 2,2 DOHC Common-Rail Diesel engines

Please carry out an up-to-date cross reference test for the specific vehicle on [www.timingtools.de](http://www.timingtools.de)

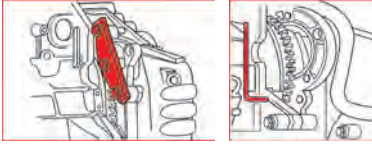

400.1625	3 pcs	Ford / Land Rover / PSA / Volvo - Engine Timing Tool Set	473
----------	-------	--	-----

consists of:

400.0580	Crankshaft locking pin Ø 8,0 mm	30
400.0609	Flywheel locking tool	308
400.0903	Crankshaft locking pin	85

**Land Rover fan hub wrench set**

- For counter holding the Visco coupling drive shaft
- Makes it possible to secure the pulley wheel of the water pump and at the same time release the heating filter
- Also suitable for the removal of the viscous connecting socket on the cooler ventilator
- Special steel

**Application range:** Land Rover Discovery II, Range Rover, Defender 1990-2006 with Td5 or V8 engines

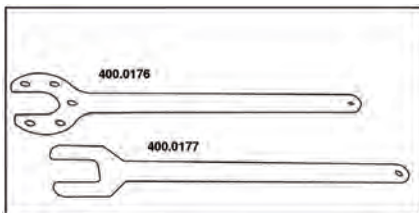

400.4175	2 pcs	Land Rover fan hub wrench set	18.29
----------	-------	-------------------------------	-------

consists of:

400.0176	Holding wrench for Visco fan for Land Rover	1.05
400.0177	Visco fan wrench 36.0 mm for Land Rover	14.78

**MAZDA**

**Ford / Mazda - Engine Timing Tool Set**

- For the professional engine repair
- For locking the crank shaft and cam shaft
- For changing the timing belt
- Very high degree of accuracy

**Application range:** Ford Mondeo with 1.8 engines and Mazda 3, 5, 6, CV7, MX5, MPV, Tribute with Zetec/Duratec or DISI engines

Please carry out an up-to-date cross reference test for the specific vehicle on [www.timingtools.de](http://www.timingtools.de)

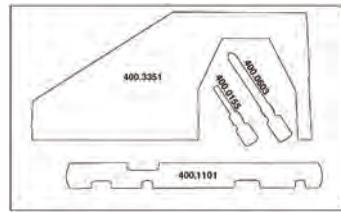
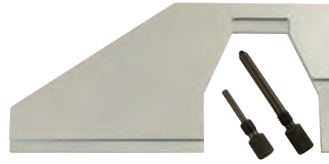
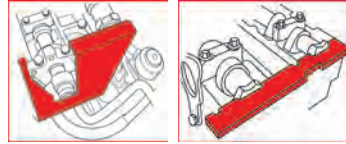

400.3350	4 pcs	Ford / Mazda - Engine Timing Tool Set	1.05
----------	-------	---------------------------------------	------

consists of:

400.0155	Crankshaft timing pin	240
400.0603	Crankshaft timing pin	51
400.1101	Camshaft setting strap	140
400.3351	Camshaft Locking Plate	780

**Ford / Mazda - Engine Timing Tool Set**

- For the professional engine repair
- For locking the crank shaft
- Especially for Ford 16V vehicles
- Very high degree of accuracy

**Application range:** Ford Fiesta 1.25 / 1.4 engines, Puma 1.4 / 1.7 engines, Mondeo 1.6 / 1.8 / 2.0 engines, Mazda 121 with 1.25 engines

Please carry out an up-to-date cross reference test for the specific vehicle on [www.timingtools.de](http://www.timingtools.de)

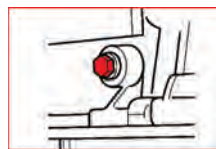

400.0175	2 pcs	Ford / Mazda - Engine Timing Tool Set	180
----------	-------	---------------------------------------	-----

consists of:

400.0154	Camshaft setting strap	150
400.0155	Crankshaft timing pin	240

**Ford / Mazda - Engine Timing Tool Set**

- For the professional engine repair
- For locking the crank shaft or cam shaft
- For changing the timing belt
- Very high degree of accuracy
- In durable steel storage case

**Application range:** Ford and Mazda vehicles with 1.2 / 1.3 / 1.4 / 1.6 SOHC and 1.6 / 1.8 / 2.0 16V petrol engines, 1.8 / 1.9 D/TD / 1.9 TDi / 2.5 TDi diesel engines and Zetec engines

Please carry out an up-to-date cross reference test for the specific vehicle on [www.timingtools.de](http://www.timingtools.de)

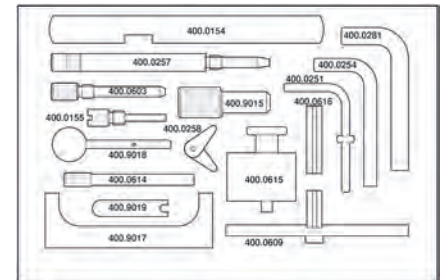
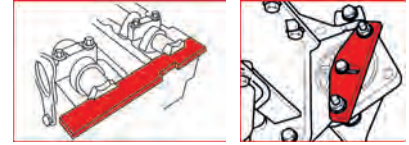

400.0600	18 pcs	Ford / Mazda - Engine Timing Tool Set	1.48
----------	--------	---------------------------------------	------

consists of:

400.0154	Camshaft setting strap	150
400.9018	Injection pump locking pin Ø 6.0 mm	20
400.0155	Crankshaft timing pin	240
400.0251	Injection pump locking pin Ø 6.0 mm	30
400.0254	Locking pin Ø 9.5 mm	60
400.0257	Crankshaft TDC locking pin	124
400.0258	Shim tool (2)	3
400.0281	Timing pin Ø 12,7 mm	569
400.0603	Crankshaft timing pin	51
400.0609	Flywheel locking tool	308
400.0614	Locking pin, Ø 8.25 mm	40
400.0615	Crankshaft pulley setting tool	190
400.0616	Flywheel locking adaptor	74
400.9015	Injection pump locking pin Ø 15.4 mm	126
400.9019	Tensioner locking tool	20
400.9017	Camshaft setting strap	120

### Mazda cam shaft locking tool

- For the professional engine repair
- Clamping device for a secure hold to change the timing belt
- Special plastic
- Very high degree of accuracy

**Application range:** Mazda 626 from 1992 / 323 from 1998, Premacy from 1999 onwards

Please carry out an up-to-date cross reference test for the specific vehicle on [www.timingtools.de](http://www.timingtools.de)



X			
150.3050	1	Mazda cam shaft locking tool	50

### MERCEDES

### Chrysler / Mercedes - Engine Timing Tool Set

- For the professional engine repair
- For locking the cam shaft
- For changing the timing chain
- Very high degree of accuracy
- In durable steel storage case

**Application range:** Mercedes vehicles with 2.2 / 2.7 CRD engines, Chrysler PT Cruiser with 2.2 CRD engines, Jeep Grand Cherokee with 2.7 CRD engines

Please carry out an up-to-date cross reference test for the specific vehicle on [www.timingtools.de](http://www.timingtools.de)

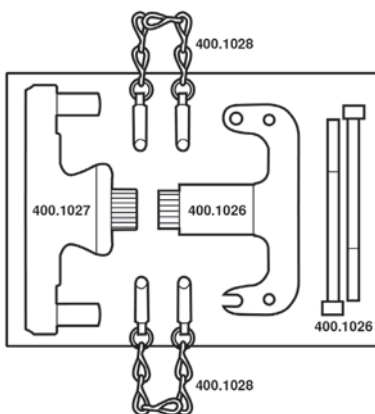
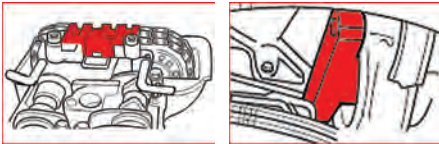

400.1025	6 pcs	Chrysler / Mercedes - Engine Timing Tool Set	1.46

consists of:

400.1026	Flywheel locking tool (3)	197	
400.1027	Flywheel locking tool	436	
400.1028	Camshaft locking tool (2)	36	

### Mercedes cam shaft locking tool

- For the professional engine repair
- For locking the cam shaft wheels when removing the cylinder head
- Secure hold thanks to optimal positioning
- Very high degree of accuracy

**Application range:** for Mercedes A-, B-, C-, CLC-, CLK-, CLS-, E-, G-, GL-, M-, R-, S-, SLK-, V classes, Sprinter, Vito and Viano with petrol engines (engine code: M104, M111, M112, M119, M120, M272, M273) and diesel engines with 4 valve technology (engine code: OM605, OM606, OM611, OM612, OM613, OM614, OM628, OM629, OM640, OM642, OM643, OM646, OM646 EVO, OM647, OM648, OM649)

Please carry out an up-to-date cross reference test for the specific vehicle on [www.timingtools.de](http://www.timingtools.de)



Suitable for		Ø	Length		
		mm	mm		
550.1193	Mercedes	5,8 x 6,0	212,0	38	

### MINI

### BMW / Mini - Engine Timing Tool Set

- For the professional engine repair
- For locking the cam shaft
- For changing the timing chain
- Very high degree of accuracy

**Application range:** BMW Mini (2001-2006) (engine code: W10B16AA/BA)

Please carry out an up-to-date cross reference test for the specific vehicle on [www.timingtools.de](http://www.timingtools.de)

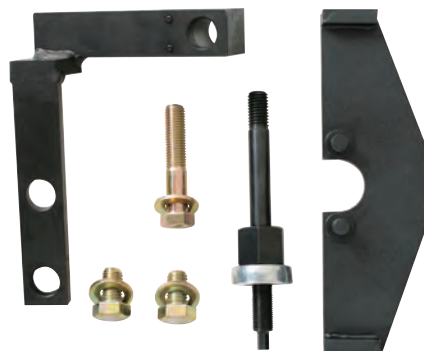
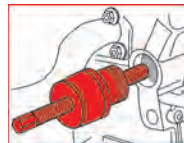

400.9090	7 pcs	BMW / Mini - Engine Timing Tool Set	1.93

consists of:

400.9091	Camshaft locking tool	575	
400.9092	Engine support bracket (4)	615	
400.9093	Timing chain pre-tensioning tool	215	

### BMW / Mini - Engine Timing Tool Set

- For the professional engine repair
- For locking the cam shaft
- For changing the timing chain
- Very high degree of accuracy
- In durable steel storage case

**Application range:** BMW Mini One, Cooper, Cooper S with 1.6 petrol engines (engine code: W10816AA / W10816BA / W11816AA)

Please carry out an up-to-date cross reference test for the specific vehicle on [www.timingtools.de](http://www.timingtools.de)

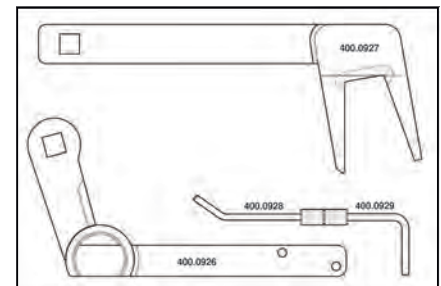

400.0925	4 pcs	BMW / Mini - Engine Timing Tool Set	2.02

consists of:

400.0926	Serpentine belt tensioner	441	
400.0927	Camshaft pulley loosening tools	421	
400.0928	Tensioning locking pin	19	
400.0929	Locking pin	20	

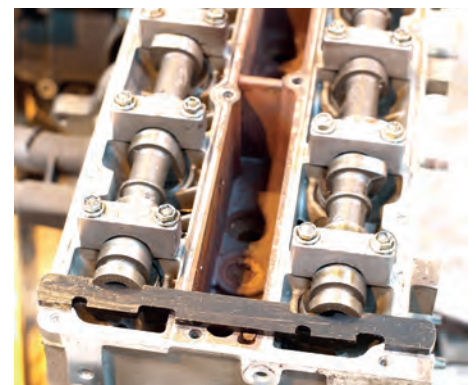

**BMW / Mini / PSA - Engine Timing Tool Set**

- For the professional engine repair
- For locking the cam shaft
- For changing the timing chain
- Very high degree of accuracy
- In durable steel storage case

**Application range:** BMW Mini with 1.6 engines (engine code: N14 / R56), Peugeot 207, 308 with 1.6 engines (engine code: EP6 / EP6DT / DTS), Citroën with 1.6 engines (engine code: EP6 / EP6DT / DTS)

Please carry out an up-to-date cross reference test for the specific vehicle on [www.timingtools.de](http://www.timingtools.de)

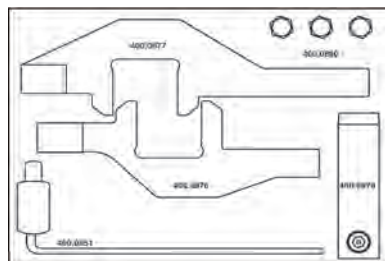
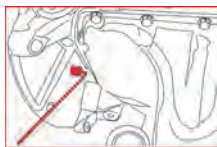

KS TOOLS			
400.0875	7 pcs	BMW / Mini / PSA - Engine Timing Tool Set	1.49

consists of:

KS TOOLS			
400.0851		Crankshaft timing pin	52
400.0876		Camshaft alignment tool (inlet)	270
400.0877		Camshaft alignment tool (exhaust)	423
400.0878		Support clamp	93
400.0880		Screw M6 x 30,0 mm (3)	7

**BMW / Mini / PSA - Engine Timing Tool Set**

- For the professional engine repair
- For locking the cam shaft
- For changing the timing chain
- Very high degree of accuracy

**Application range:** BMW Mini with 1.4 / 1.6 Valvetronic engines (engine code: N12), Peugeot 207, 308 with 1.4 / 1.6 engines (engine code: EP3 / EP6), Citroën with 1.4 / 1.6 engines (engine code: EP3 / EP6)

Please carry out an up-to-date cross reference test for the specific vehicle on [www.timingtools.de](http://www.timingtools.de)

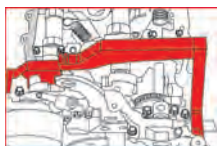

KS TOOLS			
400.0850	7 pcs	BMW / Mini / PSA - Engine Timing Tool Set	1.40

consists of:

KS TOOLS			
X			
400.0851	1	Crankshaft timing pin	52
400.0852	1	Camshaft locking tool inlet (2)	812
400.0853	1	Camshaft locking tool (EX)	358
400.0854	3	Screwn M6 x 30,0 mm	9

**BMW / Mini - Engine Timing Tool Set**

- For the professional engine repair
- For changing the timing belt
- Very high degree of accuracy

**Application range:** BMW Mini with 16V engines (engine code: W16D)

Please carry out an up-to-date cross reference test for the specific vehicle on [www.timingtools.de](http://www.timingtools.de)



KS TOOLS			
400.2475	7 pcs	BMW / Mini - Engine Timing Tool Set	126

consists of:

KS TOOLS			
400.0165		Camshaft locking pin 5.0 mm	19
400.0580		Crankshaft locking pin Ø 8,0 mm	30
400.2476		Flywheel locking pin, BMW-Mini (3)	40

**MITSUBISHI**

**Hyundai / Mitsubishi / Volvo - Engine Timing Tool Set**

- For the professional engine repair
- For actuating belt tensioners
- Very high degree of accuracy

**Application range:** universal usage on many Hyundai, Mitsubishi, Volvo vehicles

Please carry out an up-to-date cross reference test for the specific vehicle on [www.timingtools.de](http://www.timingtools.de)



KS TOOLS			
400.0075	2 pcs	Hyundai / Mitsubishi / Volvo - Engine Timing Tool Set	131

consists of:

KS TOOLS			
400.0076		Tensioning locking pin	630
400.0077		Belt tensioner wrench	210

**Mitsubishi cam shaft locking tool**

- For the professional engine repair
- Clamping device for a secure hold to change the timing belt
- Special plastic
- Very high degree of accuracy

**Application range:** Mitsubishi Space Wagon 1997 onwards

Please carry out an up-to-date cross reference test for the specific vehicle on [www.timingtools.de](http://www.timingtools.de)



KS TOOLS			
150.3051	1	Mitsubishi cam shaft locking tool	30

**Mitsubishi cam shaft locking tool**

- For the professional engine repair
- Clamping device for a secure hold to change the timing belt
- Special plastic
- Very high degree of accuracy

**Application range:** Mitsubishi Carisma from 1996 onwards, Space Star from 1997 onwards, Galant 2.0GTI from 1991 onwards

Please carry out an up-to-date cross reference test for the specific vehicle on [www.timingtools.de](http://www.timingtools.de)



KS TOOLS			
150.3052	2	Mitsubishi cam shaft locking tool	60

**Mitsubishi cam shaft locking tool**

- For the professional engine repair
- Clamping device for a secure hold to change the timing belt
- Special plastic
- Very high degree of accuracy

**Application range:** Mitsubishi 24V Galant 2.5 from 1997 onwards, 24V Sigma 3.0 from 1991 onwards, Galant 4 x 4 from 1991 onwards

Please carry out an up-to-date cross reference test for the specific vehicle on [www.timingtools.de](http://www.timingtools.de)



KS TOOLS			
150.3053	2	Mitsubishi cam shaft locking tool	60

**Mitsubishi cam shaft locking tool**

- For the professional engine repair
- Clamping device for a secure hold to change the timing belt
- Special plastic
- Very high degree of accuracy

**Application range:** Mitsubishi Pajero 3500 from 1998 onwards

Please carry out an up-to-date cross reference test for the specific vehicle on [www.timingtools.de](http://www.timingtools.de)



KS TOOLS			
150.3054	2	Mitsubishi cam shaft locking tool	70

## NISSAN

### Diesel fuel pump timing set

- For the professional engine repair
- Precise measuring device for the upper entry hole
- For resetting the injection time on diesel engines
- Very high degree of accuracy
- In durable steel storage case

**Application range:** Alfa Romeo, Audi, BMW, Daihatsu, Fiat, Ford, Isuzu, Iveco, Lancia, Land Rover, Mazda, Mitsubishi, Nissan, PSA (XUD), Renault, Rover, Volkswagen vehicles with Bosch, EP/VE Rotary, Niki, Nippon Denso, CAV RotoDiesel, Top injection fuel pumps

Please carry out an up-to-date cross reference test for the specific vehicle on [www.timingtools.de](http://www.timingtools.de)

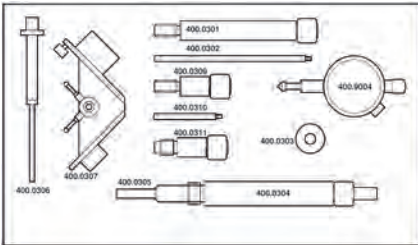

400.0300	11 pcs	Diesel fuel pump timing set	710
----------	--------	-----------------------------	-----

#### consists of:

400.0301	Dial gauge adapter M8 (Bosch), long	71
400.0302	Dial gauge extension, long 99 mm	9
400.0303	Converter M8 x M12	12
400.0304	TDC determining pin / dial indicator bracket M14 x 2.0 mm	135
400.0305	Extension	460
400.0306	Dial gauge probe for Lukas-CAV-Roto	17
400.0307	Dial gauge assy for Lukas-CAV-Roto	125
400.0309	Dial gauge adapter M8 (Bosch) short, silver	37
400.0310	Dial gauge extension short	4
400.0311	Dial gauge adapter M10 (Bosch) short, black	40
400.9004	Precision-dial indicator gauge 0 - 10 mm	78

### Diesel fuel pump timing set

- For the professional engine repair
- Precise measuring device
- Very high degree of accuracy
- In durable steel storage case

**Application range:** Alfa Romeo, Audi, BMW, Daihatsu, Fiat, Ford, Isuzu, Iveco, Lancia, Land Rover, Mazda, Mitsubishi, Nissan, Renault, Rover and Volkswagen vehicles with Bosch, Kikki, Nippon Denso injection pumps with threads of M8, M10 and M12, with new M10 Adapter in particular for Ford Transit

Please carry out an up-to-date cross reference test for the specific vehicle on [www.timingtools.de](http://www.timingtools.de)

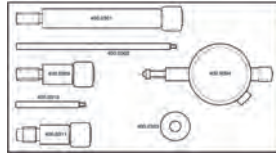
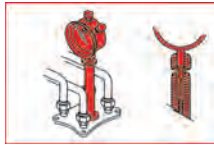

400.0325	7 pcs	Diesel fuel pump timing set	301
----------	-------	-----------------------------	-----

#### consists of:

400.0301	Dial gauge adapter M8 (Bosch), long	71
400.0302	Dial gauge extension, long 99 mm	9
400.0303	Converter M8 x M12	12
400.9004	Precision-dial indicator gauge 0 - 10 mm	78
400.0309	Dial gauge adapter M8 (Bosch) short, silver	37
400.0310	Dial gauge extension short	4
400.0311	Dial gauge adapter M10 (Bosch) short, black	40

### Nissan / Opel / Renault - Engine Timing Tool Set

- For the professional engine repair
- For locking the cam shaft
- For changing the timing belt
- Very high degree of accuracy
- In durable steel storage case

**Application range:** Renault Clio 1.5 / 1.9 / 2.3 / 2.5 dCi, Laguna II, Espace, Trafic, Master with 2.2 DTI (2000-2005) G9 engines, Opel Movano 2.2 Tdi, Nissan Kubistar, Primastar, Interstar and Micra with 1.5 / 2.2 / 2.5 dCi engines

Please carry out an up-to-date cross reference test for the specific vehicle on [www.timingtools.de](http://www.timingtools.de)

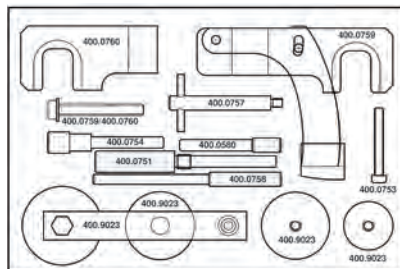
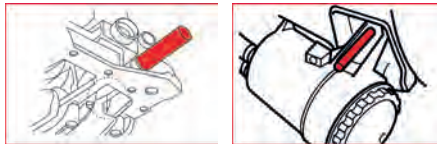

400.0750	13 pcs	Nissan / Opel / Renault - Engine Timing Tool Set	1.69
----------	--------	--	------

#### consists of:

400.0580	Crankshaft locking pin Ø 8,0 mm	30
400.0751	Crankshaft locking pin	102
400.0753	Locking screw M6 x 30,0 mm	10
400.0754	Camshaft locking pin	51
400.0757	Hi-Pressure pump locking pin	43
400.0758	Flywheel locking pin	55
400.0759	Camshaft setting tool (exhaust) (2)	20
400.0760	Camshaft setting tool (inlet)	223
400.9023	Renault cam belt tensioning tool	669

### Nissan / Renault - Engine Timing Tool Set

- For the professional engine repair
- For locking the cam shaft
- For changing the timing chain
- Very high degree of accuracy
- In durable steel storage case

**Application range:** Renault Megane, Vel Satis, Espace, Scenic, Trafic, Laguna, Koleos, Nissan Qashqai, Opel Vivaro with 2.0 dCi engine (engine code: M9R)

Please carry out an up-to-date cross reference test for the specific vehicle on [www.timingtools.de](http://www.timingtools.de)

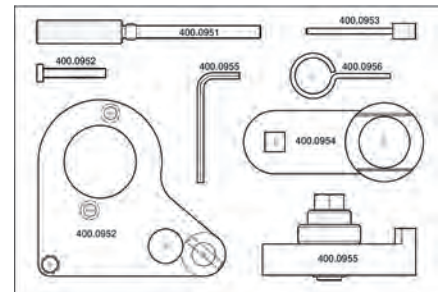
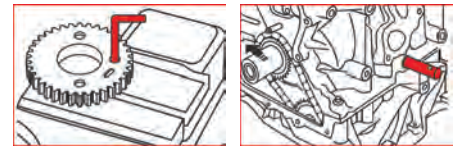

400.0950	8 pcs	Nissan / Renault - Engine Timing Tool Set	2.73
----------	-------	---	------

#### consists of:

400.0951	Crankshaft locking pin	103
400.0952	Camshaft locking tool	398
400.0953	Auxilliary drive belt tensioning locking pin	13
400.0954	Crankshaft pulley holding tool	424
400.0955	Camshaft gear alignment tool (2)	593
400.0956	Locking pin Ø 2,96 mm	6

**Nissan fixing pin injection pump wheel**

- For the professional engine repair
- Ideally suited to securing the injection pump
- Simple handling
- Special steel
- Very high degree of accuracy

**Application range:** Nissan Almera, Almera Tino, Cabstar, Navara, Pathfinder, Primera, X-Trail with 2.2 and 2.5 Diesel engines

Please carry out an up-to-date cross reference test for the specific vehicle on [www.timingtools.de](http://www.timingtools.de)



400.9047	Nissan fixing pin injection pump wheel	18
----------	--	----

**Diesel pump adjustment tool**

- Secure stand for the pump wheel when assembling and disassembling the high pressure pump
- exact positioning of the pump wheel
- no need to disassemble the tooth belt
- saves work of making further adjustments to the pump
- Saves a lot of time
- Special steel

**Application range:** Diesel engines F9Q for Opel, Renault, and Nissan vehicles



400.9051	Diesel pump adjustment tool	420
----------	-----------------------------	-----

**OPEL**

**GM / Opel - Engine Timing Tool Set**

- For the professional engine repair
- For locking the cam shaft or chain tensioner
- Very high degree of accuracy

**Application range:** Opel Astra-G, Vectra-B, Vectra-C, Signum, Zafira-A (engine code: Z22SE / Z22YH)

Please carry out an up-to-date cross reference test for the specific vehicle on [www.timingtools.de](http://www.timingtools.de)



400.2325	2 pcs GM / Opel - Engine Timing Tool Set	787
----------	--	-----

consists of:

400.2326	Camshaft locking tool	786
400.2327	Timing chain tensioner locking pin	1

**Fiat / Ford / Opel /Suzuki - Engine Timing Tool Set**

- For the professional engine repair
- Especially for chain-driven engines
- For changing the steering chain
- Very high degree of accuracy
- In durable steel storage case

**Application range:** Fiat 1.3 JTD, Opel 1.3 CDTI, Ford 1.3 TDCi, Suzuki (engine code: Z13DT)

Please carry out an up-to-date cross reference test for the specific vehicle on [www.timingtools.de](http://www.timingtools.de)

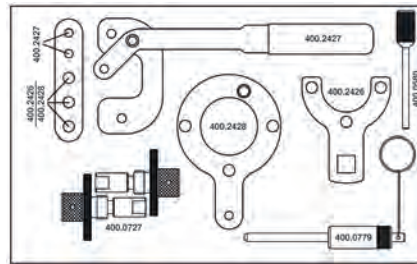
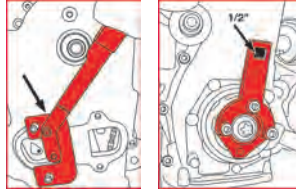

400.2425	12 pcs Fiat / Ford / Opel /Suzuki - Engine Timing Tool Set	1.12
----------	--	------

consists of:

400.0580	Crankshaft locking pin Ø 8,0 mm	30
400.0727	Camshaft locking tool (2)	130
400.0779	Crankshaft locking tool	80
400.2426	Crankshaft pulley flange holding tool (4)	88
400.2427	Timing chain tensioning tool (3)	171
400.2428	Flywheel timing position tool	398



**GM / Opel / Saab - Engine Timing Tool Set**

- For the professional engine repair
- For locking the cam shaft
- For changing the timing belt or the chain
- Very high degree of accuracy
- In durable steel storage case

**Application range:** Opel Agila, Corsa-C, Combo-C (2003-2007), Tigra-B, Meriva, Astra-H (2004-2007), Corsa-D (2006-2007) with 1.3 CDTi engines (engine code: Z13DT / Z13DTH / Z13DTJ), Opel Astra-H, Vectra-C, Signum, Zafira-B with 1.9 CDTi engines (engine code: Z19DT / Z19DTL), Saab 9-3, 905 with 1.9 CDTi engines (engine code: Z19DT / Z19DTH)

Please carry out an up-to-date cross reference test for the specific vehicle on [www.timingtools.de](http://www.timingtools.de)

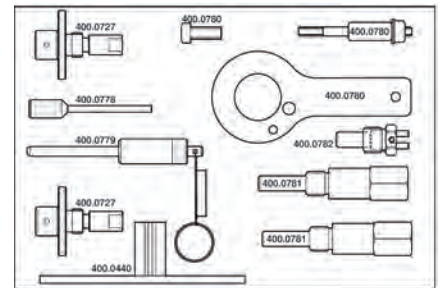
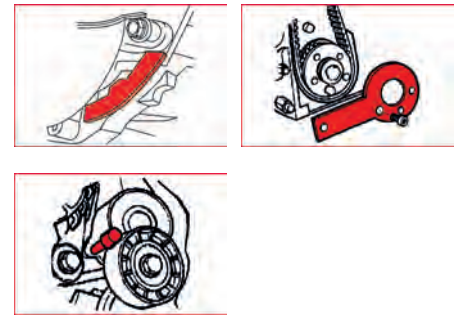

400.0775	11 pcs GM / Opel / Saab - Engine Timing Tool Set	1.29
----------	--	------

consists of:

400.0440	Flywheel locking tool	136
400.0727	Camshaft locking tool (2)	130
400.0778	Locking pin	20
400.0779	Crankshaft locking tool	80
400.0780	Crankshaft pulley setting tool (3)	260
400.0781	Camshaft timing pin set (2)	180
400.0782	Camshaft alignment screw	40

### GM / Opel / Saab - Engine Timing Tool Set

- For the professional engine repair
- For locking the cam shaft
- For changing the timing belt or the chain
- Very high degree of accuracy
- In durable steel storage case

**Application range:** Opel Astra-G (1998-2006), Vectra-B, Vectra-C (1997 - 2005), Signum (2003-2005), Omega-B (1998-2003), Zafira-A (1999-2005), Sintra (1998-1999), Frontera-B (1998-2004) with 2.0 / 2.2 DTi engines (engine code: Z20DTH / Z20DTL / Z22DTH / Z22DTR) and Saab 9-3 (1998-2004) with 2.2 TID, 9-5 (2002-2007) with 2.2 TID engines (engine code: D223L)

Please carry out an up-to-date cross reference test for the specific vehicle on [www.timingtools.de](http://www.timingtools.de)

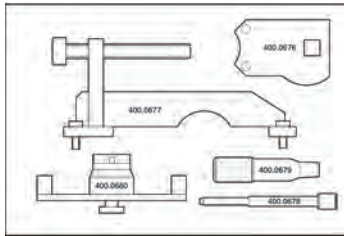

400.0675	5 pcs	GM / Opel / Saab - Engine Timing Tool Set	1.36
----------	-------	---	------

consists of:

400.0676	Camshaft turning tool	7	
400.0677	Bracket for timing adjustment wrench	111	
400.0678	Injection pump locking pin	41	
400.0679	Flywheel TDC locking pin	160	
400.0680	Camshaft locking tool	322	

### GM / Opel / Saab - Engine Timing Tool Set

- For the professional engine repair
- For engines with bevel on the automatic pulley
- Very high degree of accuracy
- In durable steel storage case

**Application range:** Opel Vectra-B, Omega-B, Sintra, Calibra with 2.5 / 2.6 / 3.0 V6 engines (1998-2003) (engine code: X25XE, X30XE, Y26SE, Y32SE), Saab 9-5 with 3.0 V6 engines (engine code: B308E)

Please carry out an up-to-date cross reference test for the specific vehicle on [www.timingtools.de](http://www.timingtools.de)

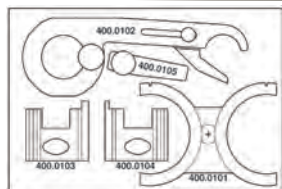

400.0100	5 pcs	GM / Opel / Saab - Engine Timing Tool Set	2.44
----------	-------	---	------

consists of:

400.0101	Crankshaft locking tool	812	
400.0102	Camshaft locking tool	585	
400.0103	Opel Camshaft locking tool (right)	119	
400.0104	Camshaft locking tool left	120	
400.0105	Belt holding wedge	100	

### Isuzu / GM / Opel / Saab - Engine Timing Tool Set

- For the professional engine repair
- For changing the timing belt
- Very high degree of accuracy
- In durable steel storage case

**Application range:** Opel Agila, Ascona, Astra-F, Astra-G, Corsa-B, Corsa-C, Frontera, Kadett-E, Midi, Monterey, Omega-B, Sintra, Vectra-A, Vectra-B, Vectra-C, Zafira and similar Isuzu and Saab vehicles

Please carry out an up-to-date cross reference test for the specific vehicle on [www.timingtools.de](http://www.timingtools.de)

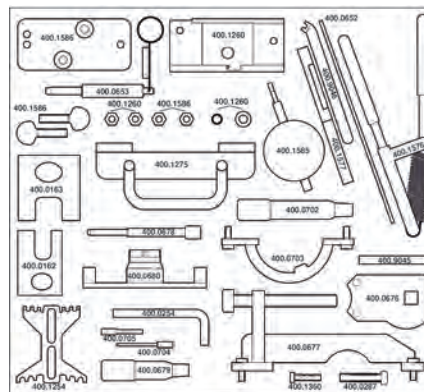
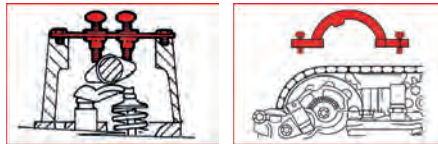

consists of:

X		
400.1262	1 Special tip	10
400.1263	1 Mounting bracket assy	330
400.1264	1 Dial gauge Ø 51 (10 x 0.01 mm)	161
400.1275	1 Camshaft setting strap (TDC)	404
400.9045	1 Flywheel locking tool	80
400.9046	1 Flywheel locking tool	80

**GM / Opel - Engine Timing Tool Set**

- For the professional engine repair
- For locking the cam shaft
- For changing the timing belt
- Very high degree of accuracy

**Application range:** Opel Antara, Chevrolet Captiva, Curze, Epica, Lacetti with 2.0 SOHC 16V Common-Rail diesel engine (engine code: Z20DM / Z20DMH / LLWZ20DMH / RA420 / Z20SI / Z20S3 / Z20S4 / Z20S5)

Please carry out an up-to-date cross reference test for the specific vehicle on [www.timingtools.de](http://www.timingtools.de)

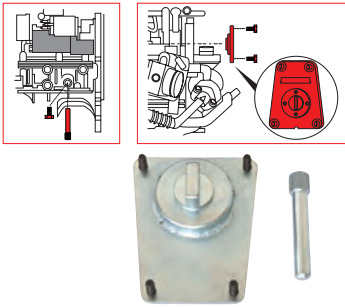

400.0050	6 pcs GM / Opel - Engine Timing Tool Set	748

consists of:

400.0051	Crankshaft locking pin	70
400.0052	Camshaft locking tool	650
400.0053	Screw M6 x 20,0 mm (4)	6

**GM / Isuzu / Opel / Saab - Engine Timing Tool Set**

- For the professional engine repair
- Especially for chain-driven vehicles
- For locking dual cam shafts
- Very high degree of accuracy
- In durable steel storage case

**Application range:** Opel Agila, Astra-G, Astra-H, Combo-C, Corsa-B, Corsa-C, Corsa-D, Meriva-A, Tigra-B (1993-2010) with 1.0 12V / 1.2 16V engines (engine code: X10XE / Z10XE / Z10 XEP / X12XE / Z12XE / Z12 XEP / Z14XEL / Z14XEA) and similar Isuzu- and Saab-engines

Please carry out an up-to-date cross reference test for the specific vehicle on [www.timingtools.de](http://www.timingtools.de)

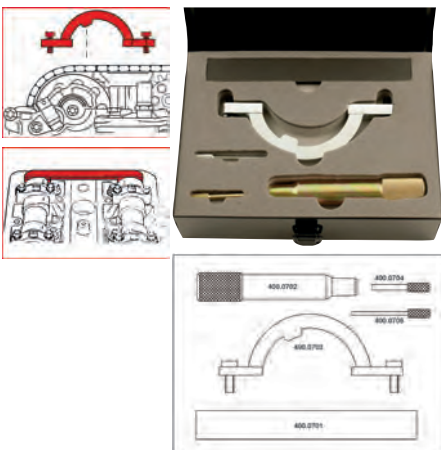

400.0700	5 pcs GM / Isuzu / Opel / Saab - Engine Timing Tool Set	446

consists of:

400.0701	Camshaft timing tool	404
400.0702	Flywheel TDC locking pin	205
400.0703	Camshaft position (CMP) sensor disc setting tool	102
400.0704	Tensioner retaining pin	4
400.0705	Tensioner retaining pin	5

**Nissan / Opel / Renault - Engine Timing Tool Set**

- For the professional engine repair
- For locking the cam shaft
- For changing the timing belt
- Very high degree of accuracy
- In durable steel storage case

**Application range:** Renault Clio 1.5 / 1.9 / 2.3 / 2.5 dCi, Laguna II, Espace, Trafic, Master with 2.2 DTI (2000-2005) G9 engines, Opel Movano 2.2 Tdi, Nissan Kubistar, Primastar, Interstar and Micra with 1.5 / 2.2 / 2.5 dCi engines

Please carry out an up-to-date cross reference test for the specific vehicle on [www.timingtools.de](http://www.timingtools.de)

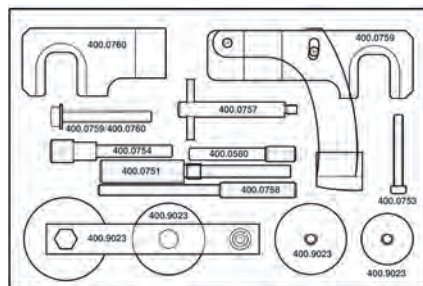
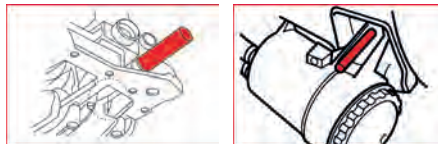

400.0750	13 pcs Nissan / Opel / Renault - Engine Timing Tool Set	1.69

consists of:

400.0580	Crankshaft locking pin Ø 8,0 mm	30
400.0751	Crankshaft locking pin	102
400.0753	Locking screw M6 x 30,0 mm	10
400.0754	Camshaft locking pin	51
400.0757	Hi-Pressure pump locking pin	43
400.0758	Flywheel locking pin	55
400.0759	Camshaft setting tool (exhaust) (2)	20
400.0760	Camshaft setting tool (inlet)	223
400.9023	Renault cam belt tensioning tool	669

**GM / Opel - Engine Timing Tool Set**

- For the professional engine repair
- Expansion set
- For engines without thread attachment bore holes
- Very high degree of accuracy

**Application range:** Opel Astra-F, Astra-G, Cavalier, Vectra-A (1997 - 2001) with 1.7 engines (engine code: 17DR / X17DT / DTL)

Please carry out an up-to-date cross reference test for the specific vehicle on [www.timingtools.de](http://www.timingtools.de)



400.0650	5 pcs GM / Opel - Engine Timing Tool Set	380

consists of:

400.0651	Camshaft locking tool (3)	169
400.0652	Flywheel TDC indicator	80
400.0653	Flywheel locking pin	79



**Fiat / GM / Opel / PSA / Renault - Engine Timing Tool Set**

- For the professional engine repair
- For changing the timing belt
- Very high degree of accuracy

**Application range:** Fiat, PSA, Renault, Opel vehicles with 2.5 / 2.8D engines

Please carry out an up-to-date cross reference test for the specific vehicle on [www.timingtools.de](http://www.timingtools.de)

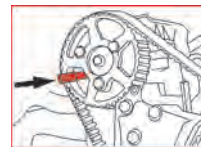

400.1775	4 pcs Fiat / GM / Opel / PSA / Renault - Engine Timing Tool Set	143

consists of:

400.0165	Camshaft locking pin 5.0 mm	19
400.0754	Camshaft locking pin	51
400.1388	Tensioner adjuster	41

### GM / Opel - Engine Timing Tool Set

- For the professional engine repair
- For locking the crank shaft and cam shaft
- For changing the timing belt
- Very high degree of accuracy
- In durable steel storage case

**Application range:** Opel Adam, Ampera, Astra-J, Aveo, Corsa-D, Insignia, Meriva-B, Mokka, Zafira-C Tourer with 1.0 / 1.2 / 1.4 engines (engine code: LWD / L2Z / LDD / LUU/A14XFL / LDD/A14XER / LDD/A14XEL / LUJ/A14NET / LUJ/A14NEL / A10XEP / A12XEL / A12XER / A14XEL / A14XER / A14NEL / LUJ/A14NET / LDD/A14XER / LUJ/A14NET / LUH/A14NEL / LUJ/A14NET / LUJ/A14NEL / L2Q/A12XEL / LDC/A12XER / LWD/A12XEL / LDD/A14XEL / LDD/A14XER)

Please carry out an up-to-date cross reference test for the specific vehicle on [www.timingtools.de](http://www.timingtools.de)

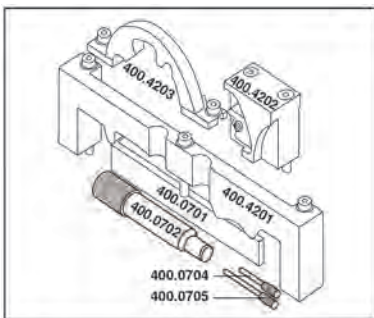
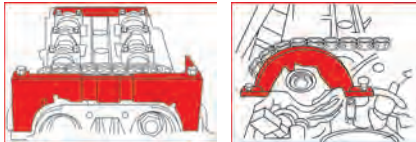

400.4200	7 pcs	GM / Opel - Engine Timing Tool Set	2.18

consists of:

400.0701		Camshaft timing tool	404
400.0702		Flywheel TDC locking pin	205
400.0704		Tensioner retaining pin	4
400.0705		Tensioner retaining pin	5
400.4201		Cam shaft sensor disc adjustment tool	340
400.4202		Camshaft adjustment tool (inlet)	340
400.4203		Cam shaft sensor locking tool	180



### Alfa Romeo / Fiat / GM / Opel - Engine Timing Tool Set

- For the professional engine repair
- For changing the timing belt
- Very high degree of accuracy

**Application range:** Chevrolet Cruze, Orlando with 1.4 / 1.6 / 1.8 engines, Opel Astra-G, Astra-H, Corsa-D, Insignia, Meriva, Signum, Vectra-C, Zafira-B, Fiat Croma, Alfa Romeo 159 (engine code: Z / A / 939A.4.000)

Please carry out an up-to-date cross reference test for the specific vehicle on [www.timingtools.de](http://www.timingtools.de)

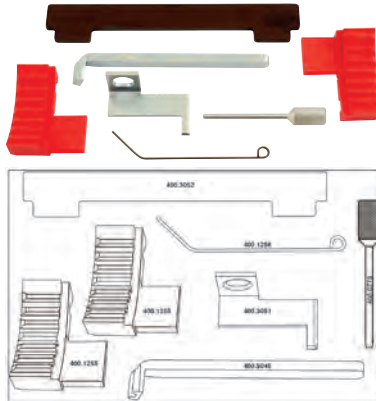

400.3050	7 pcs	Alfa Romeo / Fiat / GM / Opel - Engine Timing Tool Set	424

consists of:

400.0778		Locking pin	20
400.1255		Camshaft locking tool (2)	56
400.1256		Tensioner locking pin	3
400.3051		Flywheel holding tool	32
400.3052		Camshaft Locking Bar	148
400.9046		Flywheel locking tool	80

### GM / Opel Fly wheel locking tool

- For locking the fly wheels
- For easily attaching to one of the small fixing pins next to the fly wheel
- Special steel

**Application range:** for all Opel and GM 4 and 6 cylinder CIH, 24V and OHC engines

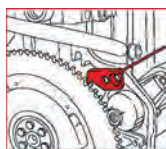

400.9045		GM / Opel Fly wheel locking tool	80

### GM / Opel / Saab Fly wheel locking tool

- For locking the fly wheels
- Secure hold thanks to optimal positioning
- Special steel

**Application range:** Opel and Saab vehicles (1996 - 2005, engine code: Z18XE)

Please carry out an up-to-date cross reference test for the specific vehicle on [www.timingtools.de](http://www.timingtools.de)



400.9046		GM / Opel / Saab Fly wheel locking tool	80

### Flywheel holding key

- To lock the flywheel
- Required for the removal and installation of disc flywheels, clutch pressure plates and belt pulleys
- Sturdy design

**Application range:** Opel with front-wheel drive

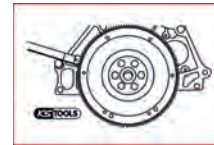

Suitable for	Length mm	Width mm	Total depth mm		
150.2438	Opel	255.0	26.0	26.0	500

### Universal fly wheel locking tool set

- For the professional engine repair
- For locking the fly wheels
- Secure hold thanks to optimal positioning
- Special plastic
- Very high degree of accuracy

**A Fly wheel Locking device for: Citroën:** Synergie 2.0/Turbo.ZX 1.9D/TD, Xantia 1.9D/TD, Berlingo 1.9D, Dispatch 1.9D/TD, Synergie1.9D, Relay 1.9D/TD, Fiat: Ulysse, 2.0/Turbo Ducato 2.0, FSO: 1.9D, LDV: 200 1.9D, Pilot 1.9D, Peugeot: 205 1.6/1.9, 305 1.6/1.9, 309 1.6/1.9, 405 1.6/1.9, 405 1.8/2.0 (92-), 605 2.0, Boxer 2.0, c205 1.8/1.9D, 305 1.8/1.9D, 306 1.8/1.9D/TD, 309 1.8/1.9D 1.8TD, 405 1.8TD, 405 1.9D, 406 1.9D, Partner 1.9D, Talbot / Horizon / Solara 1.9D, J5/Talbot Express 1.9D, 605D/TD, 806 1.9TD, Expert 1.9D, Boxer 1.9D/TD, Renault: R5, 1.6D, R9 1.6D, 411 1.6D Express/Extra 1.6D-F8M diesel engines, Clio, Express/Extra, 1.9D earlier F8Q diesel engines, Espace 2.1D, R21 2.1D, R25 2.1D, Trafic/Master 2.1D-J8S diesel engines, Clio 1.2/1.4, Express/Extra, R19 1.4, Megane/Scenic 1.4/1.6-E7F/E7J petrol engines, R5 1.7, Clio 1.7/1.8, R19 1.7, R21 1.7 1.7 Megane/Scenic 2.0, Laguna 1.8/2.0, Trafic 1.7-F3N/F3P/F2R petrol engines, Clio, Williams, R19, Megane 2.0 16V Twin-Cam F7P/F7R engines, Laguna/ Safrane 2.0 16V Twin-Cam N7Q/N7U engines

**B Fly wheel Locking device for: Renault:** Clio, Twingo, Kangoo, Megane/Scenic, 1.2/1.6 D7F + K7M Petrol engine, Megane/Scenic, Kangoo 1.9D FBQ + F9Q Diesel engine (direct injection)

**C Fly wheel Locking device for: Citroën:** Xsara, Xantia 1.8/2.0XU7 JP/JB petrol engines, Xsara 1.8 16V XU7 JP4 twin cam shaft engines, ZX.Xantia, XM2.0 16V XU10J4 twin cam shaft engines, Xantia 1.9D/TD XUD9BTF diesel engines, Xantia, XM2.1TD XUD 11BTE diesel engines, Peugeot: 406, 1.8/2.0 XU7 JP/JB Petrol engine, 406 1.8 16V XU7 JP4 Double cam shaft engines, 306, 405, 605 2.0 16V XU10J4 Double cam shaft engines, 406, 1.9D/TD XUD9BTF Diesel engines, 406, 605 2.1 TD XUD 11BTE Diesel engines

**D Fly wheel Locking device for Vauxhall/Opel:** 1.2, 1.4, 1.6, 1.8, 2.0 OHC Petrol engines, 1.6D & 1.7, OHC Diesel engines, 1.5 & 1.7 OHE Diesel (Isuzu)-Engines

Please carry out an up-to-date cross reference test for the specific vehicle on [www.timingtools.de](http://www.timingtools.de)

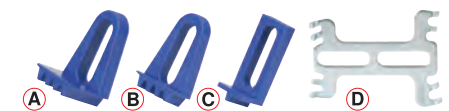

150.3025	4 pcs	Universal fly wheel locking tool set	30



**Counter hold wrench, 39.0 mm**

- For turning the water pump
- To tighten / depressurize the drive belt
- Burnished
- Special steel

**Application range:** Opel/Vauxhall, GM OHC engines



1/2"

	mm	Length mm	g
516.1004	39	90.0	100

**Counter hold wrench, 41.0 mm**

- For turning the water pump
- To tighten / depressurize the drive belt
- Burnished
- Special steel

**Application range:** Opel/Vauxhall, GM OHC engines 1.2, 1.3, 1.4 and 1.6 l

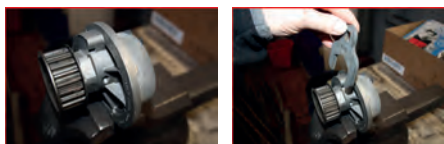

1/2"

	mm	Length mm	g
516.1002	41	90.0	110

**Counter hold wrench, 46.0 mm**

- For turning the water pump
- To tighten / depressurize the drive belt
- Burnished
- Special steel

**Application range:** Suitable for Opel and GM OHC engines

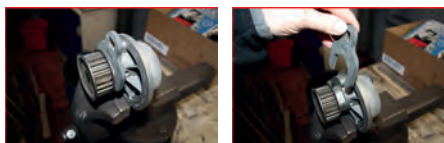

1/2"

	mm	Length mm	g
516.1001	46	90.0	120

**GM / Isuzu / Opel / Saab - Camshaft locking tool**

- For the professional engine repair
- Clamping device for a secure hold to change the timing belt
- Aluminium
- Very high degree of accuracy

**Application range:** Opel Tigra 2004 - 2008 (engine code: Z18XE) with 1.8 engines, Frontera, Frontera-B and Sintra-A, Omega-B 1995 - 2004 (engine code: X22SE, X33XE, YEESE, Y22XE Z22XE) with 2.2 16V engines. Saab 9-3 1996 - 2005 with 1.8 engines (engine code: Z18XE) and similar Isuzu and Saab engines

Please carry out an up-to-date cross reference test for the specific vehicle on [www.timingtools.de](http://www.timingtools.de)

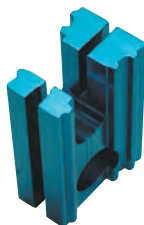

	X	g
400.0162	1 GM / Isuzu / Opel / Saab - Camshaft locking tool	186

**GM / Opel Camshaft locking tool (left)**

- For the professional engine repair
- Clamping device for a secure hold to change the timing belt
- Aluminium
- Very high degree of accuracy

**Application range:** Opel Vectra-B, Omega-B, Sintra, Calibra (engine code: X25XE, X30XE, Y26SE, Y32SE)

Please carry out an up-to-date cross reference test for the specific vehicle on [www.timingtools.de](http://www.timingtools.de)

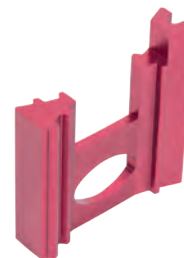

	X	g
400.0104	1 GM / Opel Camshaft locking tool (left)	120

**GM / Opel Camshaft locking tool**

- For the professional engine repair
- Clamping device for a secure hold to change the timing belt
- Aluminium
- Very high degree of accuracy

**Application range:** Opel Omega-B 1995 - 2004 (engine code: X22SE, X22XE, Y22SE, Y22XE, Z22XE) with 2.2 16V and Astra-G 2.0 16V and Vectra 1.8/2.0 16V 1995 - 2000 (engine code: X18XE, C20SEL, X20XE)

Please carry out an up-to-date cross reference test for the specific vehicle on [www.timingtools.de](http://www.timingtools.de)



	X	g
400.0163	1 GM / Opel Camshaft locking tool	143

**GM / Opel Camshaft locking tool (right)**

- For the professional engine repair
- Clamping device for a secure hold to change the timing belt
- Aluminium
- Very high degree of accuracy

**Application range:** Opel Vectra-B, Omega-B, Sintra, Calibra (engine code: X25XE, X30XE, Y26SE, Y32SE)

Please carry out an up-to-date cross reference test for the specific vehicle on [www.timingtools.de](http://www.timingtools.de)



	X	g
400.0103	1 GM / Opel Camshaft locking tool (right)	119

**GM / Opel Camshaft locking tool**

- For the professional engine repair
- Clamping device for a secure hold to change the timing belt
- Aluminium
- Very high degree of accuracy

**Application range:** Opel Astra G, Astra H, Meriva, Zafira 2003 - 2007 (engine code: Z16LET, Z16XEP) with 1.6 16V engines

Please carry out an up-to-date cross reference test for the specific vehicle on [www.timingtools.de](http://www.timingtools.de)



	X	g
400.2800	2 GM / Opel Camshaft locking tool	590

**GM / Opel cam shaft locking tool**

- For the professional engine repair
- Clamping device for a secure hold to change the timing belt
- Special plastic
- Very high degree of accuracy

**Application range:** Opel Ecotec 1.4 - 1.6 - 16V from 1993 onwards, Corsa B - Tigra - Astra F - Vectra

Please carry out an up-to-date cross reference test for the specific vehicle on [www.timingtools.de](http://www.timingtools.de)



	X	g
150.3059	1 GM / Opel cam shaft locking tool	30

### GM / Opel cam shaft locking tool

- For the professional engine repair
- Clamping device for a secure hold to change the timing belt
- Special plastic
- Very high degree of accuracy

**Application range:** Opel Ecotec 1.8 - 2.0 - 2.2 - 16V from 1995 onwards, Astra, Frontera, Sintra, Omega, Vectra

Please carry out an up-to-date cross reference test for the specific vehicle on [www.timingtools.de](http://www.timingtools.de)



X			
150.3061	1	GM / Opel cam shaft locking tool	30

### GM / Opel cam shaft locking tool

- For the professional engine repair
- Clamping device for a secure hold to change the timing belt
- Special plastic
- Very high degree of accuracy

**Application range:** Opel with small cam shaft wheels 1.8 - 2.0 - 16V from 1993 onwards, Astra, Calibra, Omega 1.4 - 1.6

Please carry out an up-to-date cross reference test for the specific vehicle on [www.timingtools.de](http://www.timingtools.de)



X			
150.3062	1	GM / Opel cam shaft locking tool	30

### GM / Opel cam shaft locking tool

- For the professional engine repair
- Clamping device for a secure hold to change the timing belt
- Special plastic
- Very high degree of accuracy

**Application range:** Opel right 2.5i - 2.0i - 16V from 1994 onwards / Vectra - Omega, Saab 900 - 9000

Please carry out an up-to-date cross reference test for the specific vehicle on [www.timingtools.de](http://www.timingtools.de)



X			
150.3063	1	GM / Opel cam shaft locking tool	30

### GM / Opel cam shaft locking tool

- For the professional engine repair
- Clamping device for a secure hold to change the timing belt
- Special plastic
- Very high degree of accuracy

**Application range:** Opel Left 2.5i - 3.0i - 16V from 1994 onwards/ Vectra - Omega, Saab 900 - 9000

Please carry out an up-to-date cross reference test for the specific vehicle on [www.timingtools.de](http://www.timingtools.de)

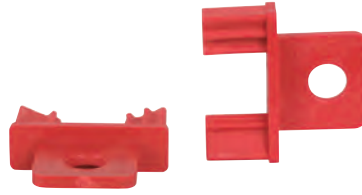

X			
150.3064	1	GM / Opel cam shaft locking tool	30

### GM / Opel cam shaft locking tool

- For the professional engine repair
- Clamping device for a secure hold to change the timing belt
- Special plastic
- Very high degree of accuracy

**Application range:** Opel engines Z16XEP and Z18XER Astra, Zafira, Vectra

Please carry out an up-to-date cross reference test for the specific vehicle on [www.timingtools.de](http://www.timingtools.de)

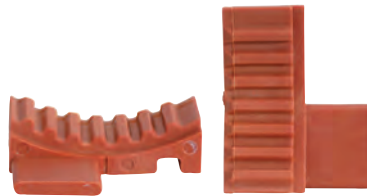

X			
150.3068	2	GM / Opel cam shaft locking tool	60



### PEUGEOT

#### PSA - Engine Timing Tool Set

- For the professional engine repair
- For changing the timing belt
- Very high degree of accuracy
- In durable steel storage case

**Application range:** Citroën, Peugeot vehicles with HPI and HDI engines

Please carry out an up-to-date cross reference test for the specific vehicle on [www.timingtools.de](http://www.timingtools.de)

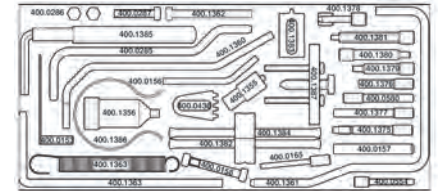
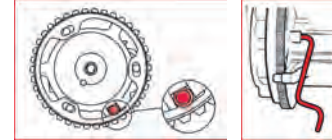

400.1650	34 pcs	PSA - Engine Timing Tool Set	2.17

#### consists of:

400.0153	Tensioner adjuster, square 8.0 mm	6	
400.0156	Crankshaft timing pin Ø 6,0 mm	23	
400.0157	Crankshaft locking pin Ø 6,0 mm, short (2)	101	
400.0158	Crankshaft locking pin (2)	30	
400.0165	Camshaft locking pin 5.0 mm	19	
400.0285	Crankshaft locking pin Ø 8,0 mm	97	
400.0286	Screw M8 x 35 mm (2)	16	
400.0436	Flywheel locking tool	135	
400.0554	Locking pin Ø 6.0 mm	19	
400.0580	Crankshaft locking pin Ø 8,0 mm	30	
400.1355	Flywheel locking pin	80	
400.1356	Flywheel locking tool	252	
400.1360	Flywheel locking tool	82	
400.1361	Flywheel locking tool	146	
400.1362	Locking screw M8 x 70.0 mm	31	
400.1363	Flywheel locking pin with spring	126	
400.1375	Injection pump timing pin, M8	32	
400.1376	Camshaft locking pin	24	
400.1377	Tensioning locking pin	35	
400.1378	Camshaft locking pin (2)	21	
400.1379	Camshaft locking pin	37	
400.1380	Camshaft locking pin	43	
400.1381	Camshaft locking pin (VTC)	50	
400.1382	Tensioner adjuster	115	
400.1383	Flywheel locking tool	30	
400.1384	Tensioner adjuster	118	
400.1385	Tensioner adjuster, hex Ø 8.0 mm	177	
400.1386	Belt retaining tool	50	
400.1387	Crankshaft pulley remover	153	

**PSA - Engine Timing Tool Set**

- For the professional engine repair
- For changing the timing belt
- Very high degree of accuracy
- In durable steel storage case

**Application range:** PSA vehicles including 2nd generation with EW 16V and 2.5 / 2.7 / 2.8 diesel engines

Please carry out an up-to-date cross reference test for the specific vehicle on [www.timingtools.de](http://www.timingtools.de)

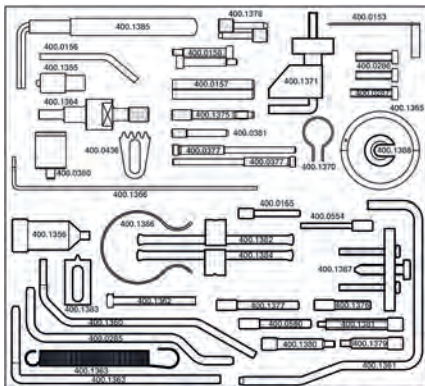
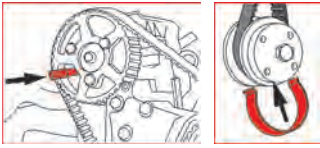

400.1350	45 pcs	PSA - Engine Timing Tool Set	5.93
----------	--------	------------------------------	------

consists of:

X		Q
400.0153	1 Tensioner adjuster, square 8.0 mm	6
400.0156	1 Crankshaft timing pin Ø 6,0 mm	23
400.0157	1 Crankshaft locking pin Ø 6,0 mm, short (2)	101
400.0158	1 Crankshaft locking pin (2)	30
400.0165	2 Camshaft locking pin 5.0 mm	19
400.0285	1 Crankshaft locking pin Ø 8,0 mm	97
400.0286	1 Screw M8 x 35 mm (2)	16
400.0287	1 Screw M8 x 40,0 mm	18
400.0377	1 Camshaft sprocket locking pin (2)	68
400.0380	1 Flywheel locking tool	222
400.0381	1 Coolant Pump tensioning locking pin	30
400.0436	1 Flywheel locking tool	135
400.0554	1 Locking pin Ø 6.0 mm	19
400.0580	1 Crankshaft locking pin Ø 8,0 mm	30
400.1355	1 Flywheel locking pin	80
400.1356	1 Flywheel locking tool	252
400.1360	1 Flywheel locking tool	82
400.1361	1 Flywheel locking tool	146
400.1362	1 Locking screw M8 x 70.0 mm	31
400.1363	1 Flywheel locking pin with spring	126
400.1364	1 Flywheel locking pin	215
400.1365	1 Tensioner pulley adjusting tool	330
400.1366	1 Tensioner adjuster, square, 6.0 mm	44
400.1370	1 Crankshaft sprocket centraliser	2
400.1371	1 Belt retaining tool	99
400.1375	1 Injection pump timing pin, M8	32

consists of:

X		Q
400.1376	1 Camshaft locking pin	24
400.1377	1 Tensioning locking pin	35
400.1378	1 Camshaft locking pin (2)	21
400.1379	1 Camshaft locking pin	37
400.1380	1 Camshaft locking pin	43
400.1381	1 Camshaft locking pin (VTC)	50
400.1382	1 Tensioner adjuster	115
400.1383	1 Flywheel locking tool	30
400.1384	1 Tensioner adjuster	118
400.1385	1 Tensioner adjuster, hex Ø 8.0 mm	177
400.1386	1 Belt retaining tool	50
400.1387	1 Crankshaft pulley remover	153
400.1388	1 Tensioner adjuster	41

**PSA - Engine Timing Tool Set**

- For the professional engine repair
- For changing the timing belt
- Very high degree of accuracy
- In durable steel storage case

**Application range:** Citroën Xsara, Picasso, C5, C4, Evasion, Synergie, C8, Jumpy, Dispatch, Peugeot 206, 307, 406, 607, 806, 807, Expert (engine code: EW12J4(3FC) / EW10D-HPI(RLZ) / EW10J4S(RFK) / EW10J4(RFN/RFR) / EW7J4(6FZ)

Please carry out an up-to-date cross reference test for the specific vehicle on [www.timingtools.de](http://www.timingtools.de)

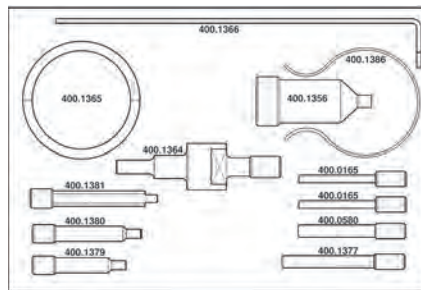
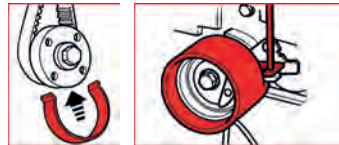

400.1750	12 pcs	PSA - Engine Timing Tool Set	1.26
----------	--------	------------------------------	------

consists of:

X		Q
400.1356	1 Flywheel locking tool	252
400.1752	1 Flywheel locking pin	215
400.1753	1 Tensioner adjusting tool	330
400.1754	1 Tensioner adjuster	18
400.1755	1 Camshaft locking pin, Ø 5 mm, 2 pcs	19
400.1756	1 Crankshaft locking pin	31
400.1757	1 Tensioning locking pin	35
400.1758	1 Camshaft locking pin	37
400.1759	1 Camshaft locking pin	43
400.1760	1 Camshaft locking pin (VTC) inlet	50
400.1386	1 Belt retaining tool	50

**PSA crank shaft locking tool set**

- For the professional engine repair
- For fixing the crank shaft
- Contains special square wrench for adjusting the timing belt on the automatic pulley
- For changing the timing belt
- Secure hold for changing the timing belt or engine repairs
- Very high degree of accuracy

**Application range:** Citroën AX with 1.0/1.1 and 1.4 engines, BX 16, BX 19, BX 16 valve, Peugeot 106, 205, 405 with 1.0/1.1 and 1.4 engines, Peugeot 205, 305, 309, 405 with 1.6 and 1.9 engines, 309 GTI, 405 Mi1,6

Please carry out an up-to-date cross reference test for the specific vehicle on [www.timingtools.de](http://www.timingtools.de)

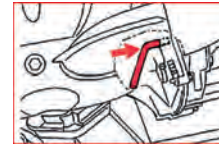

400.0200	6 pcs	PSA crank shaft locking tool set	235
----------	-------	----------------------------------	-----

consists of:

X		Q
400.0153	1 Tensioner adjuster, square 8.0 mm	6
400.0156	1 Crankshaft timing pin Ø 6,0 mm	23
400.0157	1 Crankshaft locking pin Ø 6.0 mm, short (2)	101
400.0158	1 Crankshaft locking pin (2)	30

**Fiat / GM / Opel / PSA / Renault - Engine Timing Tool Set**

- For the professional engine repair
- For changing the timing belt
- Very high degree of accuracy

**Application range:** Fiat, PSA, Renault, Opel vehicles with 2.5 / 2.8D engines

Please carry out an up-to-date cross reference test for the specific vehicle on [www.timingtools.de](http://www.timingtools.de)

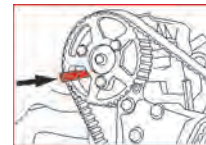

400.1775	4 pcs	Fiat / GM / Opel / PSA / Renault - Engine Timing Tool Set	143
----------	-------	---	-----

consists of:

X		Q
400.0165	1 Camshaft locking pin 5.0 mm	19
400.0754	1 Camshaft locking pin	51
400.1388	1 Tensioner adjuster	41

1  
2  
3  
4  
5  
6  
7  
8  
9  
10  
11  
12  
13  
14  
15  
16  
17  
18  
19  
20  
21  
22  
23  
24  
25  
26

### PSA - Valve spring compressor

- For the professional engine repair
- For retaining the valve springs
- Universal usage
- Includes 8 screws with pressure cone and 2 locking screws
- Chrome vanadium
- Very high degree of accuracy

**Application range:** Citroën Berlingo, Xsara petrol engines with 1.0, 1.1, 1.4, 1.6l, and Peugeot 106, 205, 206, 306, 307, 405 with petrol engines

Please carry out an up-to-date cross reference test for the specific vehicle on [www.timingtools.de](http://www.timingtools.de)

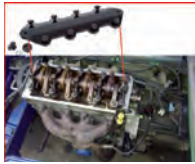

Suitable for		Length mm	
400.9001	PSA	390.0	2.50

### Fiat / PSA - Engine Timing Tool Set

- For the professional engine repair
- For adjusting the valve controls
- For twin cam shaft systems with timing belt/chain combinations
- Very high degree of accuracy
- In durable steel storage case

**Application range:** Citroën and Fiat with 2.0 / 2.2 SOHC and DOHC engines (engine code: DW10 / DW12)

Please carry out an up-to-date cross reference test for the specific vehicle on [www.timingtools.de](http://www.timingtools.de)

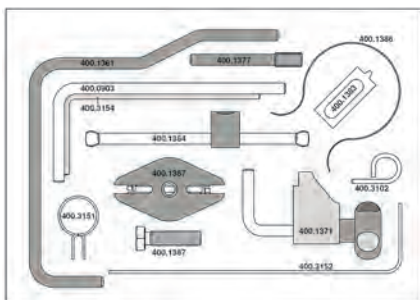
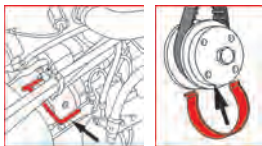

400.3150	12 pcs Fiat / PSA - Engine Timing Tool Set	814

consists of:

400.0903	Crankshaft locking pin	85
400.1361	Flywheel locking tool	146
400.1371	Belt retaining tool	99
400.1377	Tensioning locking pin	35
400.1383	Flywheel locking tool	30
400.1384	Tensioner adjuster	118
400.1386	Belt retaining tool	50
400.1387	Crankshaft pulley remover	153
400.3102	Tensioner locking pin	4
400.3151	Crankshaft pulley centralisation tool	2
400.3152	Tensioner locking pin	7
400.3154	Auxiliary drive belt tensioner locking pin Ø 4.0 mm	18



### PSA - Engine Timing Tool Set

- For the professional engine repair
- For locking the crank shaft or cam shaft
- For changing the timing belt
- Very high degree of accuracy

**Application range:** PSA vehicles with 1.4 8V and 16V engines (engine code: KFV)

Please carry out an up-to-date cross reference test for the specific vehicle on [www.timingtools.de](http://www.timingtools.de)

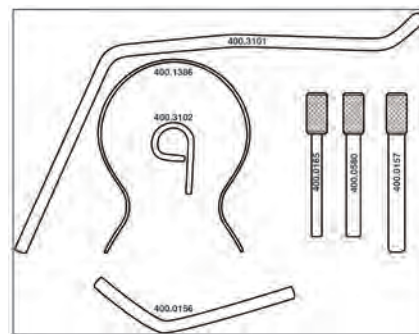
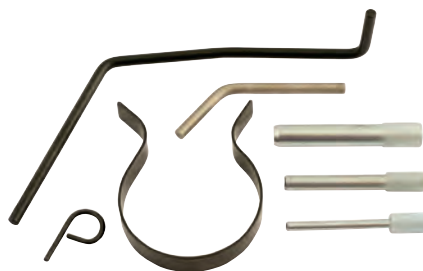

400.3100	9 pcs PSA - Engine Timing Tool Set	362

consists of:

400.0156	Crankshaft timing pin Ø 6,0 mm	23
400.0157	Crankshaft locking pin Ø 6,0 mm, short (2)	101
400.0165	Camshaft locking pin 5,0 mm	19
400.0580	Crankshaft locking pin Ø 8,0 mm	30
400.1386	Belt retaining tool	50
400.3101	Flywheel locking pin Ø 6,0 mm, long	58
400.3102	Tensioner locking pin	4

### BMW / Mini / PSA - Engine Timing Tool Set

- For the professional engine repair
- For locking the cam shaft
- For changing the timing chain
- Very high degree of accuracy

**Application range:** BMW Mini with 1.4 / 1.6 Valvetronic engines (engine code: N12), Peugeot 207, 308 with 1.4 / 1.6 engines (engine code: EP3 / EP6), Citroën with 1.4 / 1.6 engines (engine code: EP3 / EP6)

Please carry out an up-to-date cross reference test for the specific vehicle on [www.timingtools.de](http://www.timingtools.de)

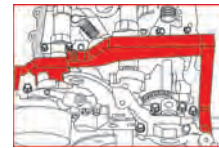

400.0850	7 pcs BMW / Mini / PSA - Engine Timing Tool Set	1.40

consists of:

		X	
400.0851	1	Crankshaft timing pin	52
400.0852	1	Camshaft locking tool inlet (2)	812
400.0853	1	Camshaft locking tool (EX)	358
400.0854	3	Screw M6 x 30,0 mm	9

### PSA / Renault - Engine Timing Tool Set

- For the professional engine repair
- For changing the timing belt
- Very high degree of accuracy
- In durable steel storage case

**Application range:** Citroën XM, Peugeot 605, Renault Safrane, Espace (engine code: L7X 700 / 701 / 713 / 727 / 731 / XFZ / ES9J4)

Please carry out an up-to-date cross reference test for the specific vehicle on [www.timingtools.de](http://www.timingtools.de)

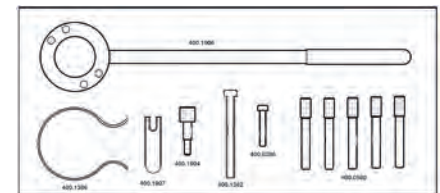
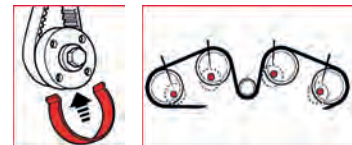

400.1900	11 pcs PSA / Renault - Engine Timing Tool Set	2.31

consists of:

		X	
400.0286	1	Screw M8 x 35 mm (2)	16
400.0580	5	Crankshaft locking pin Ø 8,0 mm	30
400.1362	1	Locking screw M8 x 70,0 mm	31
400.1386	1	Belt retaining tool	50
400.1904	1	Gauge pin	14
400.1906	1	Camshaft locking tool	896

**Ford / Land Rover / PSA / Volvo - Engine Timing Tool Set**

- For the professional engine repair
- For changing the timing belt
- Very high degree of accuracy

**Application range:** Ford, Land Rover, PSA, Volvo vehicles with 2,0 / 2,2 DOHC Common-Rail Diesel engines

Please carry out an up-to-date cross reference test for the specific vehicle on [www.timingtools.de](http://www.timingtools.de)

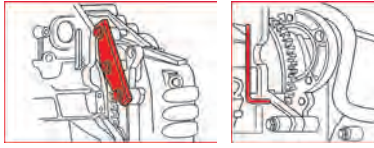

400.1625	3 pcs	Ford / Land Rover / PSA / Volvo - Engine Timing Tool Set	473
----------	-------	--	-----

consists of:

400.0580	Crankshaft locking pin Ø 8,0 mm	30
400.0609	Flywheel locking tool	308
400.0903	Crankshaft locking pin	85

**PSA timing belt tensioning tool**

- For the professional engine repair
- 8.0 mm square
- Suitable for pre-tensioning timing belt tensioner on the automatic pulley
- Chrome vanadium
- Very high degree of accuracy

**Application range:** universal usage on many Peugeot vehicles

Please carry out an up-to-date cross reference test for the specific vehicle on [www.timingtools.de](http://www.timingtools.de)



150.3014	PSA	157.0	100
----------	-----	-------	-----

**PSA / Toyota timing belt tensioning tool**

- For the professional engine repair
- 7.0 mm square
- Suitable for pre-tensioning timing belt tensioner on the automatic pulley
- Chrome vanadium
- Very high degree of accuracy

**Application range:** universal usage on many Peugeot and Toyota vehicles

Please carry out an up-to-date cross reference test for the specific vehicle on [www.timingtools.de](http://www.timingtools.de)



150.3011	PSA, Toyota	157.0	80
----------	-------------	-------	----

**Universal fly wheel locking tool set**

- For the professional engine repair
- For locking the fly wheels
- Secure hold thanks to optimal positioning
- Special plastic
- Very high degree of accuracy

**A Fly wheel Locking device for: Citroën:** Synergie 2.0/ Turbo.ZX 1.9D/TD, Xantia 1.9D/TD, Berlingo 1.9D, Dispatch 1.9D/TD, Synergie 1.9D, Relay 1.9D/TD, **Fiat:** Ulysse, 2.0/Turbo Ducato 2.0, FSO: 1.9D, LDV: 200 1.9D, Pilot 1.9D, **Peugeot:** 205 1.6/1.9, 305 1.6/1.9, 309 1.6/1.9, 405 1.6/1.9, 405 1.8/2.0 (92-), 605 2.0, Boxer 2.0, c205 1.8/1.9D, 305 1.8/1.9D, 306 1.8/1.9D/TD, 309 1.8/1.9D 1.8TD, 405 1.8TD, 405 1.9D, 406 1.9D, Partner 1.9D, Talbot / Horizon / Solara 1.9D, J5/Talbot Express 1.9D, 605D/TD, 806 1.9TD, Expert 1.9D, Boxer 1.9D/TD, **Renault:** R5, 1.6D, R9 1.6D, 411 1.6D Express/Extra 1.6D-F8M diesel engines, Clio, Express/Extra, 1.9D earlier F8Q diesel engines, Espace 2.1D, R21 2.1D, R25 2.1D, Trafic/ Master 2.1D-J8S diesel engines, Clio 1.2/1.4, Express/Extra, R19 1.4, Megane/Scenic 1.4/1.6-E7F/E7J petrol engines, R5 1.7, Clio 1.7/1.8, R19 1.7, R21 1.7 1.7 Megane/Scenic 2.0, Laguna 1.8/2.0, Trafic 1.7-F3N/F3P/F2R petrol engines, Clio, Williams, R19, Megane 2.0 16V Twin-Cam F7P/F7R engines, Laguna/ Safrane 2.0 16V Twin-Cam N7Q/N7U engines

**B Fly wheel Locking device for: Renault:** Clio, Twingo, Kangoo, Megane/Scenic, 1.2/1.6 D7F + K7M Petrol engine, Megane/Scenic, Kangoo 1.9D FBQ + F9Q Diesel engine (direct injection)

**C Fly wheel Locking device for: Citroën:** Xsara, Xantia 1.8/2.0XU7 JP/JB petrol engines, Xsara 1.8 16V XU7 JP4 twin cam shaft engines, ZX.Xantia, XM2.0 16V XU10J4 twin cam shaft engines, Xantia 1.9D/TD XUD9BTF diesel engines, Xantia, XM2.1TD XUD 11BTE diesel engines, **Peugeot:** 406, 1.8/2.0 XU7 JP/JB Petrol engine, 406 1.8 16V XU7 JP4 Double cam shaft engines, 306, 405, 605 2.0 16V XU10J4 Double cam shaft engines, 406, 1.9D/TD XUD9BTF Diesel engines, 406, 605 2.1 TD XUD 11BTE Diesel engines

**D Fly wheel Locking device for Vauxhall/Opel:** 1.2, 1.4, 1.6, 1.8, 2.0 OHC Petrol engines, 1.6D & 1.7, OHC Diesel engines, 1.5 & 1.7 OHE Diesel(Isuzu)-Engines

Please carry out an up-to-date cross reference test for the specific vehicle on [www.timingtools.de](http://www.timingtools.de)

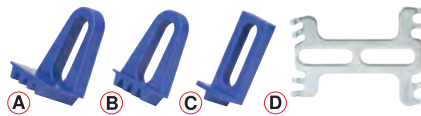

150.3025	4 pcs	Universal fly wheel locking tool set	30
----------	-------	--------------------------------------	----



**PSA**

**PSA - Engine Timing Tool Set**

- For the professional engine repair
- For changing the timing belt
- Very high degree of accuracy
- In durable steel storage case

**Application range:** Citroën, Peugeot vehicles with HPI and HDI engines

Please carry out an up-to-date cross reference test for the specific vehicle on [www.timingtools.de](http://www.timingtools.de)

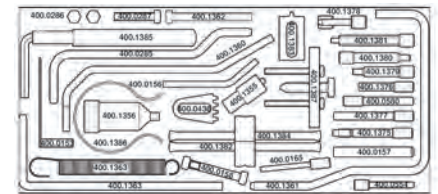
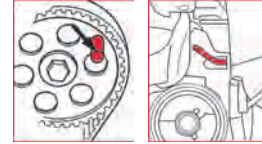

400.1650	34 pcs	PSA - Engine Timing Tool Set	2.17
----------	--------	------------------------------	------

consists of:

400.0153	Tensioner adjuster, square 8.0 mm	6
400.0156	Crankshaft timing pin Ø 6,0 mm	23
400.0157	Crankshaft locking pin Ø 6,0 mm, short (2)	101
400.0158	Crankshaft locking pin (2)	30
400.0165	Camshaft locking pin 5.0 mm	19
400.0285	Crankshaft locking pin Ø 8,0 mm	97
400.0286	Screw M8 x 35 mm (2)	16
400.0436	Flywheel locking tool	135
400.0554	Locking pin Ø 6.0 mm	19
400.0580	Crankshaft locking pin Ø 8,0 mm	30
400.1355	Flywheel locking pin	80
400.1356	Flywheel locking tool	252
400.1360	Flywheel locking tool	82
400.1361	Flywheel locking tool	146
400.1362	Locking screw M8 x 70.0 mm	31
400.1363	Flywheel locking pin with spring	126
400.1375	Injection pump timing pin, M8	32
400.1376	Camshaft locking pin	24
400.1377	Tensioning locking pin	35
400.1378	Camshaft locking pin (2)	21
400.1379	Camshaft locking pin	37
400.1380	Camshaft locking pin	43
400.1381	Camshaft locking pin (VTC)	50
400.1382	Tensioner adjuster	115
400.1383	Flywheel locking tool	30
400.1384	Tensioner adjuster	118
400.1385	Tensioner adjuster, hex Ø 8.0 mm	177
400.1386	Belt retaining tool	50
400.1387	Crankshaft pulley remover	153

### PSA - Engine Timing Tool Set

- For the professional engine repair
- For changing the timing belt
- Very high degree of accuracy
- In durable steel storage case

**Application range:** PSA vehicles including 2nd generation with EW 16V and 2.5 / 2.7 / 2.8 diesel engines

Please carry out an up-to-date cross reference test for the specific vehicle on [www.timingtools.de](http://www.timingtools.de)

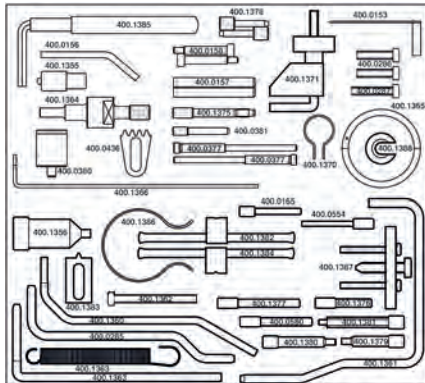
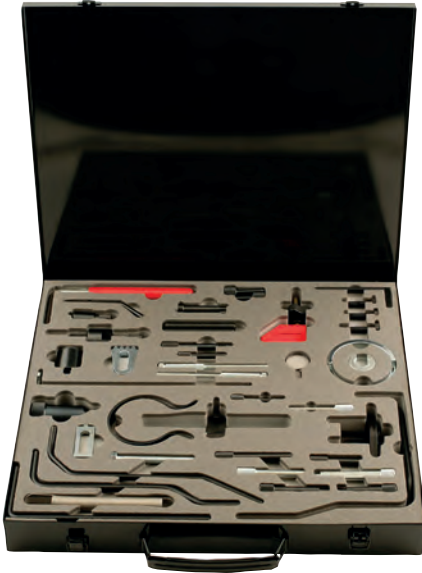
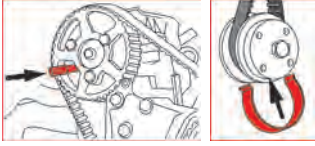

		kg
400.1350	45 pcs PSA - Engine Timing Tool Set	5.93

consists of:

X		kg
400.0153	1 Tensioner adjuster, square 8.0 mm	6
400.0156	1 Crankshaft timing pin Ø 6,0 mm	23
400.0157	1 Crankshaft locking pin Ø 6,0 mm, short (2)	101
400.0158	1 Crankshaft locking pin (2)	30
400.0165	2 Camshaft locking pin 5.0 mm	19
400.0285	1 Crankshaft locking pin Ø 8,0 mm	97
400.0286	1 Screw M8 x 35 mm (2)	16
400.0287	1 Screw M8 x 40,0 mm	18
400.0377	1 Camshaft sprocket locking pin (2)	68
400.0380	1 Flywheel locking tool	222
400.0381	1 Coolant Pump tensioning locking pin	30
400.0436	1 Flywheel locking tool	135
400.0554	1 Locking pin Ø 6,0 mm	19
400.0580	1 Crankshaft locking pin Ø 8,0 mm	30
400.1355	1 Flywheel locking pin	80
400.1356	1 Flywheel locking tool	252
400.1360	1 Flywheel locking tool	82

consists of:

X		kg
400.1361	1 Flywheel locking tool	146
400.1362	1 Locking screw M8 x 70,0 mm	31
400.1363	1 Flywheel locking pin with spring	126
400.1364	1 Flywheel locking pin	215
400.1365	1 Tensioner pulley adjusting tool	330
400.1366	1 Tensioner adjuster, square, 6,0 mm	44
400.1370	1 Crankshaft sprocket centraliser	2
400.1371	1 Belt retaining tool	99
400.1375	1 Injection pump timing pin, M8	32
400.1376	1 Camshaft locking pin	24
400.1377	1 Tensioning locking pin	35
400.1378	1 Camshaft locking pin (2)	21
400.1379	1 Camshaft locking pin	37
400.1380	1 Camshaft locking pin	43
400.1381	1 Camshaft locking pin (VTC)	50
400.1382	1 Tensioner adjuster	115
400.1383	1 Flywheel locking tool	30
400.1384	1 Tensioner adjuster	118
400.1385	1 Tensioner adjuster, hex Ø 8,0 mm	177
400.1386	1 Belt retaining tool	50
400.1387	1 Crankshaft pulley remover	153
400.1388	1 Tensioner adjuster	41

### PSA - Engine Timing Tool Set

- For the professional engine repair
- For changing the timing belt
- Very high degree of accuracy
- In durable steel storage case

**Application range:** Citroën Xsara, Picasso, C5, C4, Evasion, Synergie, C8, Jumpy, Dispatch, Peugeot 206, 307, 406, 607, 806, 807, Expert (engine code: EW12J4(3FC) / EW10D-HPI(RLZ) / EW10J4S(RFK) / EW10J4(RFN/RFR) / EW7J4(6FZ)

Please carry out an up-to-date cross reference test for the specific vehicle on [www.timingtools.de](http://www.timingtools.de)

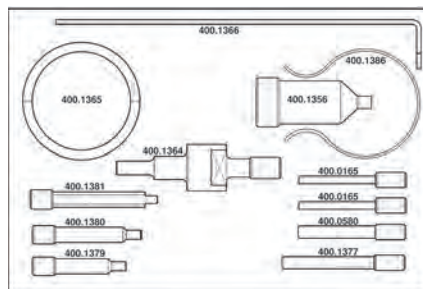
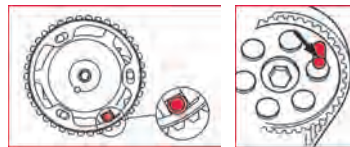

		kg
400.1750	12 pcs PSA - Engine Timing Tool Set	1.26

consists of:

X		kg
400.1356	1 Flywheel locking tool	252
400.1752	1 Flywheel locking pin	215
400.1753	1 Tensioner adjusting tool	330
400.1754	1 Tensioner adjuster	18
400.1755	1 Camshaft locking pin, Ø 5 mm, 2 pcs	19
400.1756	1 Crankshaft locking pin	31
400.1757	1 Tensioning locking pin	35
400.1758	1 Camshaft locking pin	37
400.1759	1 Camshaft locking pin	43
400.1760	1 Camshaft locking pin (VTC) inlet	50
400.1386	1 Belt retaining tool	50

### BMW / Mini / PSA - Engine Timing Tool Set

- For the professional engine repair
- For locking the cam shaft
- For changing the timing chain
- Very high degree of accuracy
- In durable steel storage case

**Application range:** BMW Mini with 1.6 engines (engine code: N14 / R56), Peugeot 207, 308 with 1.6 engines (engine code: EP6 / EP6DT / DTS), Citroën with 1.6 engines (engine code: EP6 / EP6DT / DTS)

Please carry out an up-to-date cross reference test for the specific vehicle on [www.timingtools.de](http://www.timingtools.de)

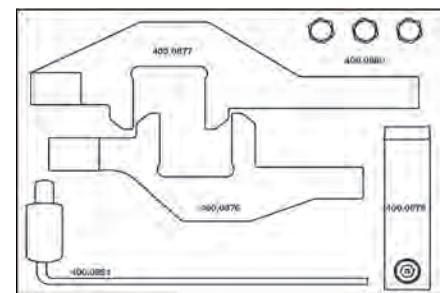
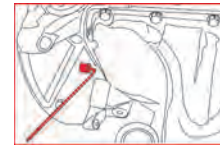

		kg
400.0875	7 pcs BMW / Mini / PSA - Engine Timing Tool Set	1.49

consists of:

X		kg
400.0851	1 Crankshaft timing pin	52
400.0876	1 Camshaft alignment tool (inlet)	270
400.0877	1 Camshaft alignment tool (exhaust)	423
400.0878	1 Support clamp	93
400.0880	1 Screw M6 x 30,0 mm (3)	7

**PSA crank shaft locking tool set**

- For the professional engine repair
- For fixing the crank shaft
- Contains special square wrench for adjusting the timing belt on the automatic pulley
- For changing the timing belt
- Secure hold for changing the timing belt or engine repairs
- Very high degree of accuracy

**Application range:** Citroën AX with 1.0/1.1 and 1.4 engines, BX 16, BX 19, BX 16 valve, Peugeot 106, 205, 405 with 1.0/1.1 and 1.4 engines, Peugeot 205, 305, 309, 405 with 1.6 and 1.9 engines, 309 GTI, 405 Mi1,6

Please carry out an up-to-date cross reference test for the specific vehicle on [www.timingtools.de](http://www.timingtools.de)

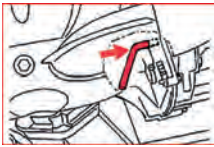

400.0200	6 pcs	PSA crank shaft locking tool set	235

consists of:

400.0153	Tensioner adjuster, square 8.0 mm	6	
400.0156	Crankshaft timing pin Ø 6.0 mm	23	
400.0157	Crankshaft locking pin Ø 6.0 mm, short (2)	101	
400.0158	Crankshaft locking pin (2)	30	

**Fiat / GM / Opel / PSA / Renault - Engine Timing Tool Set**

- For the professional engine repair
- For changing the timing belt
- Very high degree of accuracy

**Application range:** Fiat, PSA, Renault, Opel vehicles with 2.5 / 2.8D engines

Please carry out an up-to-date cross reference test for the specific vehicle on [www.timingtools.de](http://www.timingtools.de)

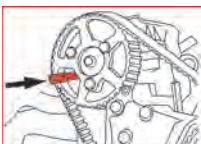

400.1775	4 pcs	Fiat / GM / Opel / PSA / Renault - Engine Timing Tool Set	143

consists of:

400.0165	Camshaft locking pin 5.0 mm	19	
400.0754	Camshaft locking pin	51	
400.1388	Tensioner adjuster	41	

**PSA - Valve spring compressor**

- For the professional engine repair
- For retaining the valve springs
- Universal usage
- Includes 8 screws with pressure cone and 2 locking screws
- Chrome vanadium
- Very high degree of accuracy

**Application range:** Citroën Berlingo, Xsara petrol engines with 1.0, 1.1, 1.4, 1.6l, and Peugeot 106, 205, 206, 306, 307, 405 with petrol engines

Please carry out an up-to-date cross reference test for the specific vehicle on [www.timingtools.de](http://www.timingtools.de)



		Suitable for	Length mm	
400.9001		PSA	390.0	2.50

**Fiat / PSA - Engine Timing Tool Set**

- For the professional engine repair
- For adjusting the valve controls
- For twin cam shaft systems with timing belt/chain combinations
- Very high degree of accuracy
- In durable steel storage case

**Application range:** Citroën and Fiat with 2.0 / 2.2 SOHC and DOHC engines (engine code: DW10 / DW12)

Please carry out an up-to-date cross reference test for the specific vehicle on [www.timingtools.de](http://www.timingtools.de)

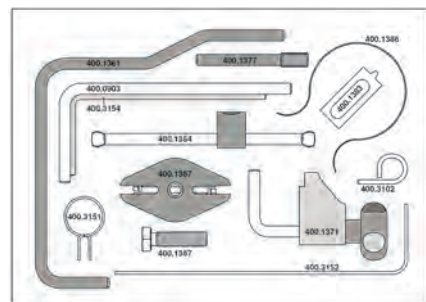
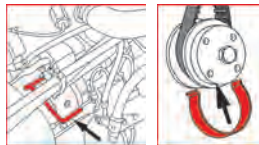

400.3150	12 pcs	Fiat / PSA - Engine Timing Tool Set	814

consists of:

400.0903	Crankshaft locking pin	85	
400.1361	Flywheel locking tool	146	
400.1371	Belt retaining tool	99	
400.1377	Tensioning locking pin	35	
400.1383	Flywheel locking tool	30	
400.1384	Tensioner adjuster	118	
400.1386	Belt retaining tool	50	
400.1387	Crankshaft pulley remover	153	
400.3102	Tensioner locking pin	4	
400.3151	Crankshaft pulley centralisation tool	2	
400.3152	Tensioner locking pin	7	
400.3154	Auxiliary drive belt tensioner locking pin Ø 4.0 mm	18	

**PSA - Engine Timing Tool Set**

- For the professional engine repair
- For locking the crank shaft or cam shaft
- For changing the timing belt
- Very high degree of accuracy

**Application range:** PSA vehicles with 1.4 8V and 16V engines (engine code: KFU)

Please carry out an up-to-date cross reference test for the specific vehicle on [www.timingtools.de](http://www.timingtools.de)

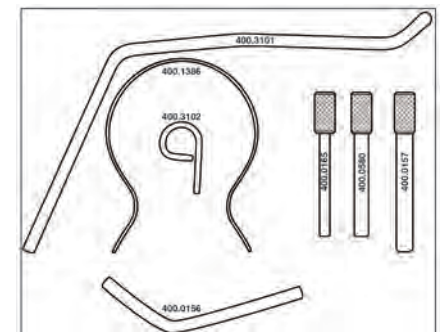
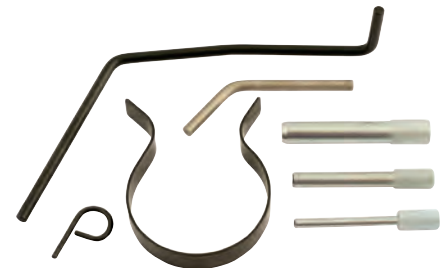

400.3100	9 pcs	PSA - Engine Timing Tool Set	362

consists of:

400.0156	Crankshaft timing pin Ø 6,0 mm	23	
400.0157	Crankshaft locking pin Ø 6.0 mm, short (2)	101	
400.0165	Camshaft locking pin 5.0 mm	19	
400.0580	Crankshaft locking pin Ø 8,0 mm	30	
400.1386	Belt retaining tool	50	
400.3101	Flywheel locking pin Ø 6.0 mm, long	58	
400.3102	Tensioner locking pin	4	

### BMW / Mini / PSA - Engine Timing Tool Set

- For the professional engine repair
- For locking the cam shaft
- For changing the timing chain
- Very high degree of accuracy

**Application range:** BMW Mini with 1.4 / 1.6 Valvetronic engines (engine code: N12), Peugeot 207, 308 with 1.4 / 1.6 engines (engine code: EP3 / EP6), Citroën with 1.4 / 1.6 engines (engine code: EP3 / EP6)

Please carry out an up-to-date cross reference test for the specific vehicle on [www.timingtools.de](http://www.timingtools.de)

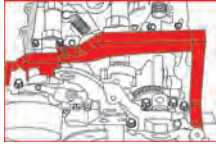

400.0850	7 pcs	BMW / Mini / PSA - Engine Timing Tool Set	1.40
----------	-------	---	------

consists of:

X			
400.0851	1	Crankshaft timing pin	52
400.0852	1	Camshaft locking tool inlet (2)	812
400.0853	1	Camshaft locking tool (EX)	358
400.0854	3	Screw M6 x 30,0 mm	9

### PSA / Renault - Engine Timing Tool Set

- For the professional engine repair
- For changing the timing belt
- Very high degree of accuracy
- In durable steel storage case

**Application range:** Citroën XM, Peugeot 605, Renault Safrane, Espace (engine code: L7X 700 / 701 / 713 / 727 / 731 / XFZ / ES9J4)

Please carry out an up-to-date cross reference test for the specific vehicle on [www.timingtools.de](http://www.timingtools.de)

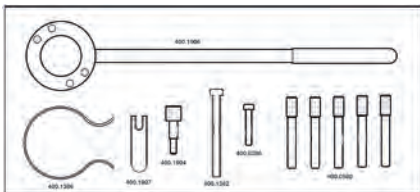
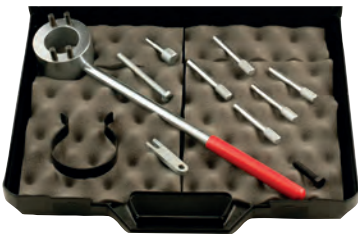
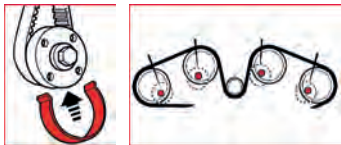

400.1900	11 pcs	PSA / Renault - Engine Timing Tool Set	2.31
----------	--------	--	------

consists of:

X			
400.0286	1	Screw M8 x 35 mm (2)	16
400.0580	5	Crankshaft locking pin Ø 8,0 mm	30
400.1362	1	Locking screw M8 x 70,0 mm	31
400.1386	1	Belt retaining tool	50
400.1904	1	Gauge pin	14
400.1906	1	Camshaft locking tool	896

### Ford / Land Rover / PSA / Volvo - Engine Timing Tool Set

- For the professional engine repair
- For changing the timing belt
- Very high degree of accuracy

**Application range:** Ford, Land Rover, PSA, Volvo vehicles with 2.0 / 2.2 DOHC Common-Rail Diesel engines

Please carry out an up-to-date cross reference test for the specific vehicle on [www.timingtools.de](http://www.timingtools.de)

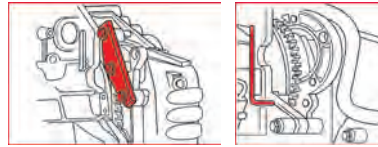

400.1625	3 pcs	Ford / Land Rover / PSA / Volvo - Engine Timing Tool Set	473
----------	-------	--	-----

consists of:

X			
400.0580	5	Crankshaft locking pin Ø 8,0 mm	30
400.0609	1	Flywheel locking tool	308
400.0903	1	Crankshaft locking pin	85

### PSA timing belt tensioning tool

- For the professional engine repair
- 8.0 mm square
- Suitable for pre-tensioning timing belt tensioner on the automatic pulley
- Chrome vanadium
- Very high degree of accuracy

**Application range:** universal usage on many Peugeot vehicles

Please carry out an up-to-date cross reference test for the specific vehicle on [www.timingtools.de](http://www.timingtools.de)



150.3014	PSA	Length mm	157,0	100
----------	-----	-----------	-------	-----

### PSA / Toyota timing belt tensioning tool

- For the professional engine repair
- 7.0 mm square
- Suitable for pre-tensioning timing belt tensioner on the automatic pulley
- Chrome vanadium
- Very high degree of accuracy

**Application range:** universal usage on many Peugeot and Toyota vehicles

Please carry out an up-to-date cross reference test for the specific vehicle on [www.timingtools.de](http://www.timingtools.de)



150.3011	PSA, Toyota	Length mm	157,0	80
----------	-------------	-----------	-------	----



### Universal fly wheel locking tool set

- For the professional engine repair
- For locking the fly wheels
- Secure hold thanks to optimal positioning
- Special plastic
- Very high degree of accuracy

**A Fly wheel Locking device for:** Citroën: Synergie 2.0/ Turbo.ZX 1.9D/TD, Xantia 1.9D/TD, Berlingo 1.9D, Dispatch 1.9D/TD, Synergie 1.9D, Relay 1.9D/TD, Fiat: Ulysse, 2.0/Turbo Ducato 2.0, FSO: 1.9D, LDV: 200 1.9D, Pilot 1.9D, Peugeot: 205 1.6/1.9, 305 1.6/1.9, 309 1.6/1.9, 405 1.6/1.9, 405 1.8/2.0 (92-), 605 2.0, Boxer 2.0, c205 1.8/1.9D, 305 1.8/1.9D, 306 1.8/1.9D/TD, 309 1.8/1.9D 1.8TD, 405 1.8TD, 405 1.9D, 406 1.9D, Partner 1.9D, Talbot / Horizon / Solara 1.9D, J5/Talbot Express 1.9D, 605D/TD, 806 1.9TD, Expert 1.9D, Boxer 1.9D/TD, Renault: R5, 1.6D, R9 1.6D, 411 1.6D Express/Extra 1.6D-F8M diesel engines, Clio, Express/Extra, 1.9D earlier F8Q diesel engines, Espace 2.1D, R21 2.1D, R25 2.1D, Trafic/ Master 2.1D-J8S diesel engines, Clio 1.2/1.4, Express/Extra, R19 1.4, Megane/Scenic 1.4/1.6-E7F/E7J petrol engines, R5 1.7, Clio 1.7/1.8, R19 1.7, R21 1.7, 1.7 Megane/Scenic 2.0, Laguna 1.8/2.0, Trafic 1.7-F3N/F3P/F2R petrol engines, Clio, Williams, R19, Megane 2.0 16V Twin-Cam F7P/F7R engines, Laguna/ Safrane 2.0 16V Twin-Cam N7Q/N7U engines

**B Fly wheel Locking device for:** Renault: Clio, Twingo, Kangoo, Megane/Scenic, 1.2/1.6 D7F + K7M Petrol engine, Megane/Scenic, Kangoo 1.9D FBQ + F9Q Diesel engine (direct injection)

**C Fly wheel Locking device for:** Citroën: Xsara, Xantia 1.8/2.0XU7 JP/JPB petrol engines, Xsara 1.8 16V XU7 JP4 twin cam shaft engines, Xantia 1.9D/TD XUD9BTF diesel engines, Xantia, XM2.1TD XUD 11BTE diesel engines, Peugeot: 406, 1.8/2.0 XU7 JP/JPB Petrol engine, 406 1.8 16V XU7 JP4 Double cam shaft engines, 306, 405, 605 2.0 16V XU10J4 Double cam shaft engines, 406, 1.9D/TD XUD9BTF Diesel engines, 406, 605 2.1 TD XUD 11BTE Diesel engines

**D Fly wheel Locking device for:** Vauxhall/Opel: 1.2, 1.4, 1.6, 1.8, 2.0 OHC Petrol engines, 1.6D & 1.7, OHC Diesel engines, 1.5 & 1.7 OHE Diesel (Isuzu)-Engines

Please carry out an up-to-date cross reference test for the specific vehicle on [www.timingtools.de](http://www.timingtools.de)

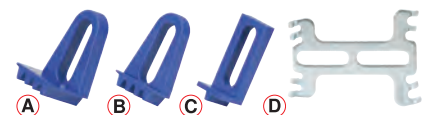

150.3025	4 pcs	Universal fly wheel locking tool set	30
----------	-------	--------------------------------------	----



RENAULT

Renault - Engine Timing Tool Set

- For the professional engine repair
- For changing the timing belt
- Very high degree of accuracy
- In durable steel storage case

**Application range:** Renault with 1.2 / 1.4 / 1.6 / 1.7 / 1.8 / 2.0 16V / 2.2 8V / 2.5 20V petrol engines and 1.2 / 1.4 / 1.7 / 1.4 / 1.6 / 1.8 / 2.0 16V / 2.2 8V / 2.5 20V diesel engines

Please carry out an up-to-date cross reference test for the specific vehicle on [www.timingtools.de](http://www.timingtools.de)

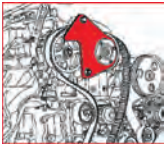

consists of:

400.1811	Tensioner adjuster	239
400.1812	Camshaft locking tool (3)	498
400.1813	Tensioner adjuster	188
400.1814	Camshaft timing tool	897
400.1815	Tensioner adjuster	138
400.9021	Tensioner adjuster	168
400.9022	Camshaft locking tool	592

Renault - Engine Timing Tool Set

- For the professional engine repair
- Expansion set for use in connection with 400.1800
- For changing the timing belt
- Very high degree of accuracy
- In durable steel storage case

**Application range:** Renault vehicles with dCi engines

Please carry out an up-to-date cross reference test for the specific vehicle on [www.timingtools.de](http://www.timingtools.de)

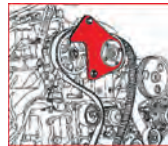

consists of:

400.0760	Camshaft setting tool (inlet)	223
400.1925	Renault - Engine Timing Tool Set , 2 pcs	567
400.9016	Injection pump wheel fixing tool	166
400.9023	Renault cam belt tensioning tool	669
400.9024	Tensioning device additional adapter	182
400.9025	Camshaft wheel fixing tool	840

Nissan / Opel / Renault - Engine Timing Tool Set

- For the professional engine repair
- For locking the cam shaft
- For changing the timing belt
- Very high degree of accuracy
- In durable steel storage case

**Application range:** Renault Clio 1.5 / 1.9 / 2.3 / 2.5 dCi, Laguna II, Espace, Trafic, Master with 2.2 DTI (2000-2005) G9 engines, Opel Movano 2.2 Tdi, Nissan Kubistar, Primastar, Interstar and Micra with 1.5 / 2.2 / 2.5 dCi engines

Please carry out an up-to-date cross reference test for the specific vehicle on [www.timingtools.de](http://www.timingtools.de)

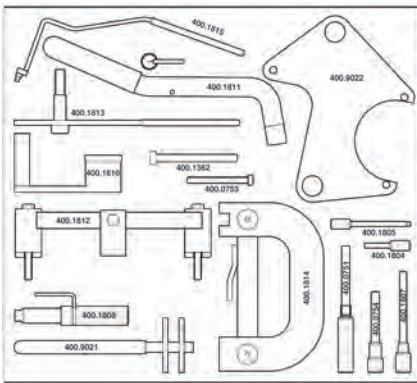
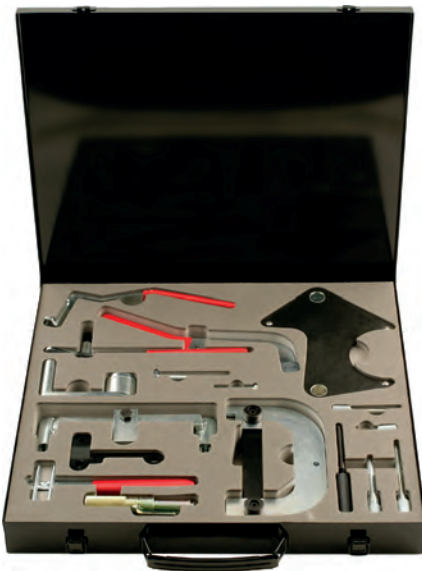
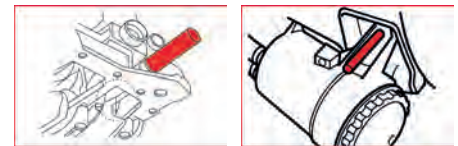

400.1800	18 pcs	Renault - Engine Timing Tool Set	4.01

consists of:

400.0751	Crankshaft locking pin	102
400.0753	Locking screw M6 x 30.0 mm	10
400.0754	Camshaft locking pin	51
400.1362	Locking screw M8 x 70.0 mm	31
400.1804	Flywheel locking pin	16
400.1805	Injection pump locking pin	20
400.1807	Flywheel locking pin	57
400.1808	Flywheel locking pin	225
400.1810	Tensioner adjuster	50

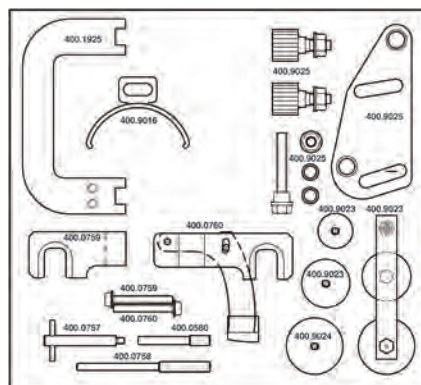

400.1450	14 pcs	Renault - Engine Timing Tool Set	5.82

consists of:

400.0580	Crankshaft locking pin Ø 8,0 mm	30
400.0757	Hi-Pressure pump locking pin	43
400.0758	Flywheel locking pin	55
400.0759	Camshaft setting tool (exhaust) (2)	20

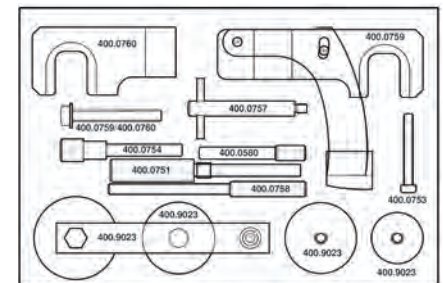

400.0750	13 pcs	Nissan / Opel / Renault - Engine Timing Tool Set	1.69

consists of:

400.0580	Crankshaft locking pin Ø 8,0 mm	30
400.0751	Crankshaft locking pin	102
400.0753	Locking screw M6 x 30.0 mm	10
400.0754	Camshaft locking pin	51
400.0757	Hi-Pressure pump locking pin	43
400.0758	Flywheel locking pin	55
400.0759	Camshaft setting tool (exhaust) (2)	20
400.0760	Camshaft setting tool (inlet)	223
400.9023	Renault cam belt tensioning tool	669

### BMW / Mini / PSA - Engine Timing Tool Set

- For the professional engine repair
- For locking the cam shaft
- For changing the timing chain
- Very high degree of accuracy
- In durable steel storage case

**Application range:** BMW Mini with 1.6 engines (engine code: N14 / R56), Peugeot 207, 308 with 1.6 engines (engine code: EP6 / EP6DT / DTS), Citroën with 1.6 engines (engine code: EP6 / EP6DT / DTS)

Please carry out an up-to-date cross reference test for the specific vehicle on [www.timingtools.de](http://www.timingtools.de)

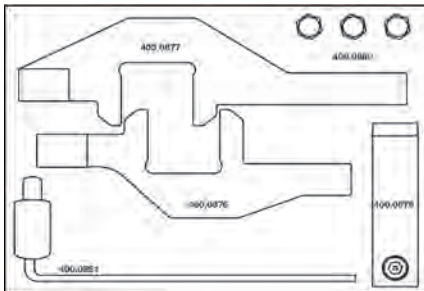
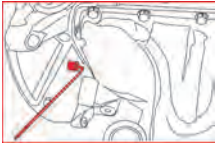

400.0875	7 pcs	BMW / Mini / PSA - Engine Timing Tool Set	1.49

consists of:

400.0851		Crankshaft timing pin	52
400.0876		Camshaft alignment tool (inlet)	270
400.0877		Camshaft alignment tool (exhaust)	423
400.0878		Support clamp	93
400.0880		Screw M6 x 30,0 mm (3)	7

### Nissan / Renault - Engine Timing Tool Set

- For the professional engine repair
- For locking the cam shaft
- For changing the timing chain
- Very high degree of accuracy
- In durable steel storage case

**Application range:** Renault Megane, Vel Satis, Espace, Scenic, Trafic, Laguna, Koleos, Nissan Qashqai, Opel Vivaro with 2.0 dCi engine (engine code: M9R)

Please carry out an up-to-date cross reference test for the specific vehicle on [www.timingtools.de](http://www.timingtools.de)

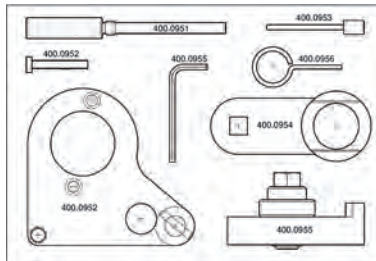
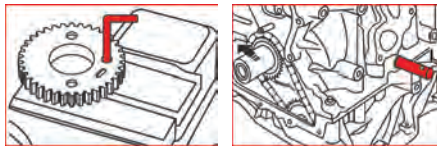

400.0950	8 pcs	Nissan / Renault - Engine Timing Tool Set	2.73

consists of:

400.0951		Crankshaft locking pin	103
400.0952		Camshaft locking tool	398
400.0953		Auxiliary drive belt tensioning locking pin	13
400.0954		Crankshaft pulley holding tool	424
400.0955		Camshaft gear alignment tool (2)	593
400.0956		Locking pin Ø 2,96 mm	6

### PSA / Renault - Engine Timing Tool Set

- For the professional engine repair
- For changing the timing belt
- Very high degree of accuracy
- In durable steel storage case

**Application range:** Citroën XM, Peugeot 605, Renault Safrane, Espace (engine code: L7X 700 / 701 / 713 / 727 / 731 / XFZ / ES9J4)

Please carry out an up-to-date cross reference test for the specific vehicle on [www.timingtools.de](http://www.timingtools.de)

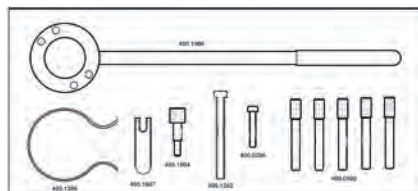

400.1900	11 pcs	PSA / Renault - Engine Timing Tool Set	2.31

consists of:

400.0286	1	Screw M8 x 35 mm (2)	16
400.0580	5	Crankshaft locking pin Ø 8,0 mm	30
400.1362	1	Locking screw M8 x 70,0 mm	31
400.1386	1	Belt retaining tool	50
400.1904	1	Gauge pin	14
400.1906	1	Camshaft locking tool	896

### Renault - Engine Timing Tool Set

- For the professional engine repair
- For changing the timing belt
- Very high degree of accuracy
- In durable steel storage case

**Application range:** Renault vehicles (engine code: K4J / K4M / F4P / F4R)

Please carry out an up-to-date cross reference test for the specific vehicle on [www.timingtools.de](http://www.timingtools.de)

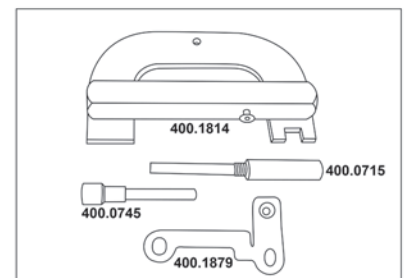

400.1875	4 pcs	Renault - Engine Timing Tool Set	1.20

consists of:

400.0751		Crankshaft locking pin	102
400.0754		Camshaft locking pin	51
400.1814		Camshaft timing tool	897
400.1879		Mounting bracket	80

**Renault - Engine Timing Tool Set**

- For the professional engine repair
- For locking the cam shaft
- Very high degree of accuracy

**Application range:** Renault Laguna, Megane (engine code: F5R)

Please carry out an up-to-date cross reference test for the specific vehicle on [www.timingtools.de](http://www.timingtools.de)



400.1925	2 pcs	Renault - Engine Timing Tool Set	567

consists of:

400.0754	Camshaft locking pin	51	
400.1926	Camshaft timing tool	459	

**Fiat / GM / Opel / PSA / Renault - Engine Timing Tool Set**

- For the professional engine repair
- For changing the timing belt
- Very high degree of accuracy

**Application range:** Fiat, PSA, Renault, Opel vehicles with 2.5 / 2.8D engines

Please carry out an up-to-date cross reference test for the specific vehicle on [www.timingtools.de](http://www.timingtools.de)

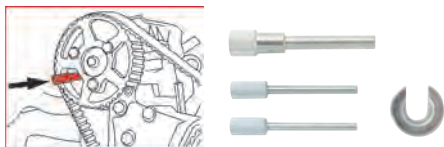

400.1775	4 pcs	Fiat / GM / Opel / PSA / Renault - Engine Timing Tool Set	143

consists of:

400.0165	Camshaft locking pin 5.0 mm	19	
400.0754	Camshaft locking pin	51	
400.1388	Tensioner adjuster	41	

**Renault cam belt tensioning tool**

- For the professional engine repair
- Contains adapter and tensioning device
- For adjusting the belt tension
- For putting on the crank shaft wheel
- Very high degree of accuracy

**Application:** Renault Mégane, Laguna, Laguna II and Espace with 1.9 dCi engines

Please carry out an up-to-date cross reference test for the specific vehicle on [www.timingtools.de](http://www.timingtools.de)



400.9023	Renault cam belt tensioning tool	669	

**Renault expansion sleeve for cam belt tensioning tool**

- For the professional engine repair
- Adapter for expanding the use for the sets 400.9023 and 400.0750
- For adjusting the belt tension
- For putting on the crank shaft wheel
- Very high degree of accuracy

**Application:** Renault Kangoo, Clio II, Megane II, Scenic II, Laguna, Laguna II, Espace III, Espace IV, Acanthime, Trafic II, Master II (engine code: F9Q, X56, X64, X65, X66-J66, X66-J66/F9Q, X70, X74, X76, X81, X83 and X84)

Please carry out an up-to-date cross reference test for the specific vehicle on [www.timingtools.de](http://www.timingtools.de)

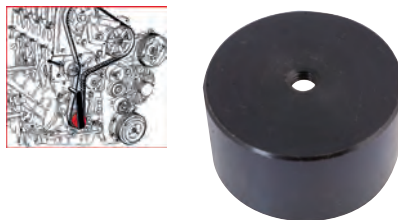

400.9024	Renault expansion sleeve for cam belt tensioning tool	182	

**Renault - Engine Timing Tool Set**

- For the professional engine repair
- For changing the timing belt
- Very high degree of accuracy
- In durable steel storage case

**Application range:** Renault Laguna, Safrane (engine code: N7U / N7Q)

Please carry out an up-to-date cross reference test for the specific vehicle on [www.timingtools.de](http://www.timingtools.de)

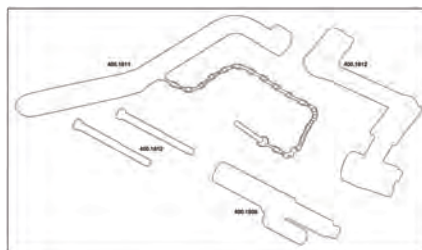

400.1850	5 pcs	Renault - Engine Timing Tool Set	1.41

consists of:

400.1808	Flywheel locking pin	225	
400.1811	Tensioner adjuster	239	
400.1812	Camshaft locking tool (3)	498	

**Renault cam shaft fixing tool**

- For the professional engine repair
- For locking the cam shafts
- Allows for correct engine adjustment
- Very high degree of accuracy

**Application:** Renault Clio II and III, Kangoo, Laguna, Mégane II, Modus, Scénic, Scénic II 2001 - 2010 with 1.4 and 1.6 16V engines (engine code: K4M)

Please carry out an up-to-date cross reference test for the specific vehicle on [www.timingtools.de](http://www.timingtools.de)

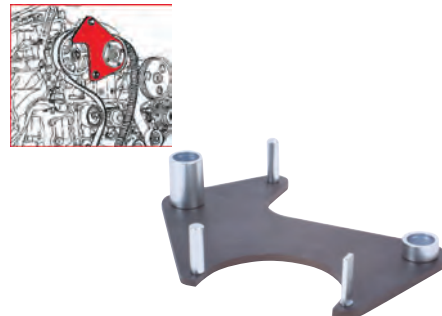

400.9022	Renault cam shaft fixing tool	592	

**Renault cam shaft fixing tool**

- For the professional engine repair
- For locking the cam shafts
- Allows for correct engine adjustment
- Very high degree of accuracy

**Application:** Renault Laguna II, Mégane II, Scénic II 2002 - 2008 with 2.0T engines (engine code: F4R770/771, F4Rt776, F4Rt784, F4Rt786, F4Rt787)

Please carry out an up-to-date cross reference test for the specific vehicle on [www.timingtools.de](http://www.timingtools.de)

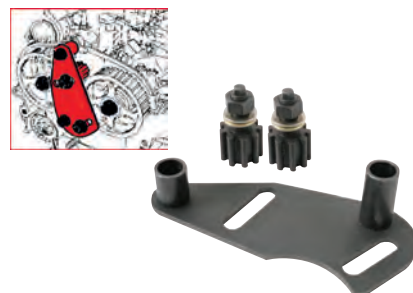

400.9025	Renault cam shaft fixing tool	840	

**Renault injection pump wheel fixing tool**

- For the professional engine repair
- For locking the injection pump chain wheel
- Simple handling
- Very high degree of accuracy

**Application:** Renault Clio, Mégane, Laguna, Kangoo with 1.9 dTi engines (engine code: F9Q)

Please carry out an up-to-date cross reference test for the specific vehicle on [www.timingtools.de](http://www.timingtools.de)

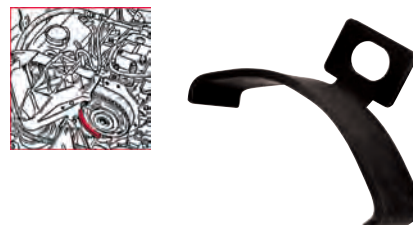

400.9016	Renault injection pump wheel fixing tool	166	

### Renault timing belt tensioning tool

- For the professional engine repair
- Suitable for pre-tensioning timing belt tensioner on the automatic pulley
- Chrome vanadium
- Very high degree of accuracy

**Application range:** Renault Twingo, Clio, Kangoo 1995 - 2006, engine code: D7F

Please carry out an up-to-date cross reference test for the specific vehicle on [www.timingtools.de](http://www.timingtools.de)



Suitable for	Length mm	Weight
150.1259 Renault	105.0	340

### Renault guide roller wrench TX T50

- Suitable for the installation and removal of the guide rollers
- Required when changing the timing belt
- For hard to reach places
- With plastic-coated handle
- Chrome vanadium

**Application range:** Renault 1.4 and 1.6 petrol engines (K4J, K4M), e.g.. Clio III, Megane, Scenic II

Please carry out an up-to-date cross reference test for the specific vehicle on [www.timingtools.de](http://www.timingtools.de)



Suitable for	Length mm	Weight
150.1302 2 pcs Renault guide roller wrench TX T50		460

consists of:

Suitable for	Length mm	Weight
150.1227 Special wrench with 8.0 mm hexagonal drive, 450 mm		440
150.1306 Bit with 8.0 mm hexagonal drive for TX screws T50		20

### Renault automatic pulley wrench

- For the professional engine repair
- Suitable for the assembly and disassembly of the timing belt
- For adjusting the timing belt tension on the automatic pulley
- With plastic-coated handle
- Chrome vanadium
- Very high degree of accuracy

**Application range:** universal usage on many Renault vehicles

Please carry out an up-to-date cross reference test for the specific vehicle on [www.timingtools.de](http://www.timingtools.de)

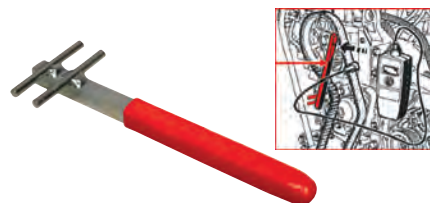

Suitable for	Length mm	Weight
400.9021 Renault automatic pulley wrench		168

### Universal fly wheel locking tool set

- For the professional engine repair
- For locking the fly wheels
- Secure hold thanks to optimal positioning
- Special plastic
- Very high degree of accuracy

**A Fly wheel Locking device for: Citroën:** Synergie 2.0/Turbo.ZX 1.9D/TD, Xantia 1.9D/TD, Berlingo 1.9D, Dispatch 1.9D/TD, Synergie 1.9D, Relay 1.9D/TD, **Fiat:** Ulysse, 2.0/Turbo Ducato 2.0, FSO: 1.9D, LDV: 200 1.9D, Pilot 1.9D, **Peugeot:** 205 1.6/1.9, 305 1.6/1.9, 309 1.8/1.9, 405 1.6/1.9, 405 1.8/2.0 (92-), 605 2.0, Boxer 2.0, c205 1.8/1.9D, 305 1.8/1.9D, 306 1.8/1.9D/TD, 309 1.8/1.9D 1.8TD, 405 1.8TD, 405 1.9D, 406 1.9D, Partner 1.9D, Talbot / Horizon / Solara 1.9D, J5/Talbot Express 1.9D, 605D/TD, 806 1.9TD, Expert 1.9D, Boxer 1.9D/TD, **Renault:** R5, 1.6D, R9 1.6D, 411 1.6D Express/Extra 1.6D-F8M diesel engines, Clio, Express/Extra, 1.9D earlier F8Q diesel engines, Espace 2.1D, R21 2.1D, R25 2.1D, Trafic/Master 2.1D-J8S diesel engines, Clio 1.2/1.4, Express/Extra, R19 1.4, Megane/Scenic 1.4/1.6-E7F/E7J petrol engines, R5 1.7, Clio 1.7/1.8, R19 1.7, R21 1.7 1.7 Megane/Scenic 2.0, Laguna 1.8/2.0, Trafic 1.7-F3N/F3P/F2R petrol engines, Clio, Williams, R19, Megane 2.0 16V Twin-Cam F7P/F7R engines, Laguna/ Safrane 2.0 16V Twin-Cam N7Q/N7U engines

**B Fly wheel Locking device for: Renault:** Clio, Twingo, Kangoo, Megane/Scenic, 1.2/1.6 D7F + K7M Petrol engine, Megane/Scenic, Kangoo 1.9D FBQ + F9Q Diesel engine (direct injection)

**C Fly wheel Locking device for: Citroën:** Xsara, Xantia 1.8/2.0XU7 JP/JB petrol engines, Xsara 1.8 16V XU7 JP4 twin cam shaft engines, ZX.Xantia, XM2.0 16V XU10J4 twin cam shaft engines, Xantia 1.9D/TD XUD9BTF diesel engines, Xantia, XM2.1TD XUD 11BTE diesel engines, **Peugeot:** 406, 1.8/2.0 XU7 JP/JB Petrol engine, 406 1.8 16V XU7 JP4 Double cam shaft engines, 306, 405, 605 2.0 16V XU10J4 Double cam shaft engines, 406, 1.9D/TD XUD9BTF Diesel engines, 406, 605 2.1 TD XUD 11BTE Diesel engines

**D Fly wheel Locking device for Vauxhall/Opel:** 1.2, 1.4, 1.6, 1.8, 2.0 OHC Petrol engines, 1.6D & 1.7, OHC Diesel engines, 1.5 & 1.7 OHE Diesel(Isuzu)-Engines

Please carry out an up-to-date cross reference test for the specific vehicle on [www.timingtools.de](http://www.timingtools.de)



Suitable for	Length mm	Weight
150.3025 4 pcs Universal fly wheel locking tool set		30



### ROVER

#### Land Rover / MG / Rover - Engine Timing Tool Set

- For the professional engine repair
- For locking the cam shaft of all KV6 variants
- For changing the timing belt
- Very high degree of accuracy
- In durable steel storage case

**Application range:** Rover 825, 45, 75, Land Rover Freelander 2.5, MG ZS, ZT, ZT-T 160, 180, 190 with 2.0 / 2.5 V6 Quad-Cam petrol engines

Please carry out an up-to-date cross reference test for the specific vehicle on [www.timingtools.de](http://www.timingtools.de)

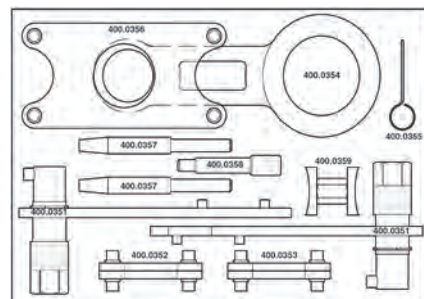

Suitable for	Length mm	Weight
400.0350 12 pcs Land Rover / MG / Rover - Engine Timing Tool Set		3.62

consists of:

Suitable for	Length mm	Weight
400.0351 Crankshaft timing tool (2)		500
400.0352 Camshaft locking adaptor set, 2.0 L (2)		76
400.0353 Camshaft locking adaptor set, 2.5 L (2)		80
400.0354 Rear camshaft sprocket setting tool		480
400.0355 Tensioner pushrod retension pin		1
400.0356 Rear camshaft sprocket setting tool		390
400.0357 Rear camshaft sprocket guide pin		50
400.0358 Crankshaft locking pin		40
400.0359 Rear cam sprocket spreader		80



consists of:

400.0705	Tensioner retaining pin	5
400.1254	Flywheel locking tool	23
400.1260	Camshaft locking tool (5)	9
400.1275	Camshaft setting strap (TDC)	404
400.1360	Flywheel locking tool	82
400.1576	Belt tensioner adjuster	297
400.1577	Camshaft setting strap	99
400.1585	Dial gauge Ø 51 (10 x 0.01 mm)	154
400.1586	Camshaft position locking tool (5)	170
400.9045	Flywheel locking tool	80
400.9046	Flywheel locking tool	80

### GM / Opel / Saab - Engine Timing Tool Set

- For the professional engine repair
- For locking the cam shaft
- For changing the timing belt or the chain
- Very high degree of accuracy
- In durable steel storage case

**Application range:** Opel Astra-G (1998-2006), Vectra-B, Vectra-C (1997 - 2005), Signum (2003-2005), Omega-B (1998-2003), Zafira-A (1999-2005), Sintra (1998-1999), Frontera-B (1998-2004) with 2.0 / 2.2 DTi engines (engine code: Z20DTH / Z20DTL / Z22DTH / Z22DTR) and Saab 9-3 (1998-2004) with 2.2 TID, 9-5 (2002-2007) with 2.2 TID engines (engine code: D223L)

Please carry out an up-to-date cross reference test for the specific vehicle on [www.timingtools.de](http://www.timingtools.de)

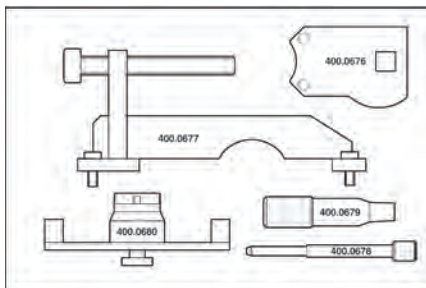
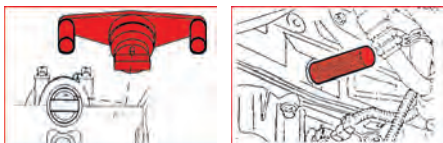

400.0675	5 pcs GM / Opel / Saab - Engine Timing Tool Set	1.36

consists of:

400.0676	Camshaft turning tool	7
400.0677	Bracket for timing adjustment wrench	111
400.0678	Injection pump locking pin	41
400.0679	Flywheel TDC locking pin	160
400.0680	Camshaft locking tool	322

### GM / Opel / Saab - Engine Timing Tool Set

- For the professional engine repair
- For engines with bevel on the automatic pulley
- Very high degree of accuracy
- In durable steel storage case

**Application range:** Opel Vectra-B, Omega-B, Sintra, Calibra with 2.5 / 2.6 / 3.0 V6 engines (1998-2003) (engine code: X25XE, X30XE, Y26SE, Y32SE), Saab 9-5 with 3.0 V6 engines (engine code: B308E)

Please carry out an up-to-date cross reference test for the specific vehicle on [www.timingtools.de](http://www.timingtools.de)

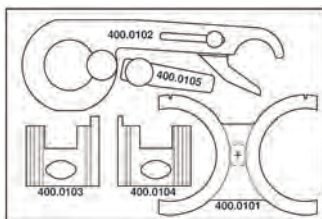

400.0100	5 pcs GM / Opel / Saab - Engine Timing Tool Set	2.44

consists of:

400.0101	Crankshaft locking tool	812
400.0102	Camshaft locking tool	585
400.0103	Opel Camshaft locking tool (right)	119
400.0104	Camshaft locking tool left	120
400.0105	Belt holding wedge	100

### GM / Isuzu / Opel / Saab - Engine Timing Tool Set

- For the professional engine repair
- Especially for chain-driven vehicles
- For locking dual cam shafts
- Very high degree of accuracy
- In durable steel storage case

**Application range:** Opel Agila, Astra-G, Astra-H, Combo-C, Corsa-B, Corsa-C, Corsa-D, Meriva-A, Tigra-B (1993-2010) with 1.0 12V / 1.2 16V engines (engine code: X10XE / Z10XE / Z10 XEP / X12XE / Z12XE / Z12 XEP / Z14XEL / Z14XEA) and similar Isuzu- and Saab-engines

Please carry out an up-to-date cross reference test for the specific vehicle on [www.timingtools.de](http://www.timingtools.de)

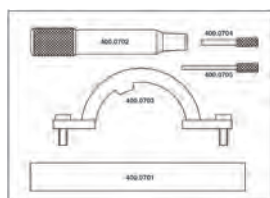
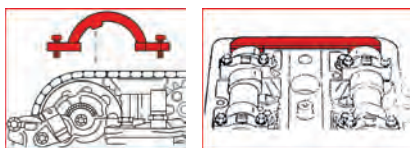

400.0700	5 pcs GM / Isuzu / Opel / Saab - Engine Timing Tool Set	446

consists of:

400.0701	Camshaft timing tool	404
400.0702	Flywheel TDC locking pin	205
400.0703	Camshaft position (CMP) sensor disc setting tool	102
400.0704	Tensioner retaining pin	4
400.0705	Tensioner retaining pin	5

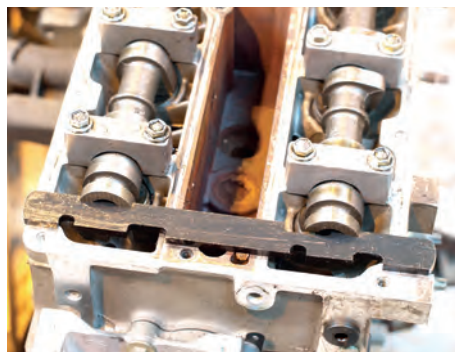

### Alfa Romeo / Fiat - Engine Timing Tool Set

- For the professional engine repair
- For locking the cam shaft
- Very high degree of accuracy
- In durable steel storage case

**Application range:** Alfa Romeo Giulietta, Mito, Fiat 500, Brava, Bravo, Grande Punto, Marea, Marea Weekend, Marengo, Palio Weekend, Panda, Punto Classic, Ritmo, Stilo, Idea, Lancia Delta, Susa, Ypsilon with 1.2 16V engines

Please carry out an up-to-date cross reference test for the specific vehicle on [www.timingtools.de](http://www.timingtools.de)

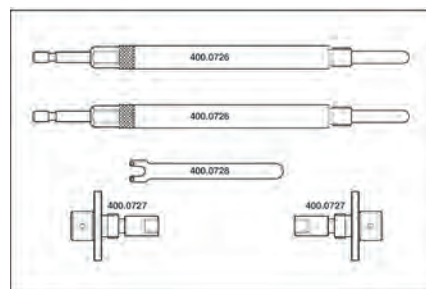

400.0725	5 pcs Alfa Romeo / Fiat - Engine Timing Tool Set	989

consists of:

400.0726	Piston height gauge (2)	250
400.0727	Camshaft locking tool (2)	130
400.0728	Tensioner adjusting tool	30

**GM / Opel / Saab - Engine Timing Tool Set**

- For the professional engine repair
- For locking the cam shaft
- For changing the timing belt or the chain
- Very high degree of accuracy
- In durable steel storage case

**Application range:** Opel Agila, Corsa-C, Combo-C (2003-2007), Tigra-B, Meriva, Astra-H (2004-2007), Corsa-D (2006-2007) with 1.3 CDTi engines (engine code: Z13DT / Z13DTH / Z13DTJ), Opel Astra-H, Vectra-C, Signum, Zafira-B with 1.9 CDTi engines (engine code: Z19DT / Z19DTL), Saab 9-3, 905 with 1.9 CDTi engines (engine code: Z19DT / Z19DTH)

Please carry out an up-to-date cross reference test for the specific vehicle on [www.timingtools.de](http://www.timingtools.de)

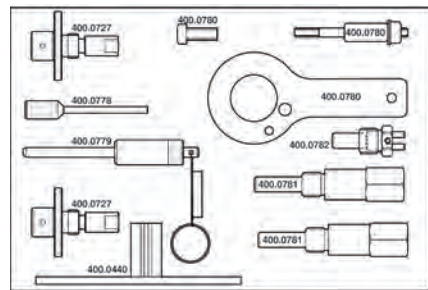

KS TOOLS			
400.0775	11 pcs	GM / Opel / Saab - Engine Timing Tool Set	1.29

consists of:

KS TOOLS		
400.0440	Flywheel locking tool	136
400.0727	Camshaft locking tool (2)	130
400.0778	Locking pin	20
400.0779	Crankshaft locking tool	80
400.0780	Crankshaft pulley setting tool (3)	260
400.0781	Camshaft timing pin set (2)	180
400.0782	Camshaft alignment screw	40

**GM / Isuzu / Opel / Saab - Engine Timing Tool Set**

- For the professional engine repair
- For locking the cam shaft
- For changing the timing belt
- Very high degree of accuracy
- In durable steel storage case

**Application range:** Opel Agila, Ascona, Astra-F, Astra-G, Astramax, Belmont, Cavalier, Corsa-B, Corsa-C, Frontera, Kadett-E, Midi, Monterey, Omega-B, Sintra, Vectra-A, Vectra-B, Vectra-C, Zafira with petrol and diesel engines including Eco-Tec engines and similar Isuzu and Saab engines

Please carry out an up-to-date cross reference test for the specific vehicle on [www.timingtools.de](http://www.timingtools.de)

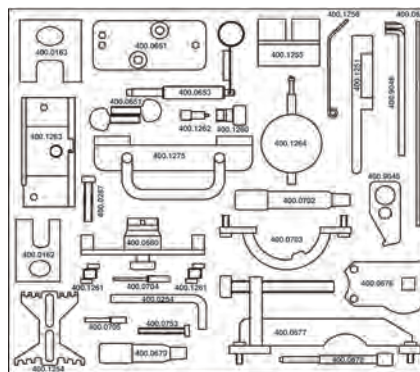
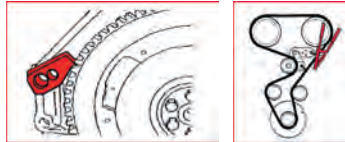

KS TOOLS			
400.1250	36 pcs	GM / Isuzu / Opel / Saab - Engine Timing Tool Set	6.18

consists of:

KS TOOLS			
400.0162	1	Opel / Saab Camshaft locking tool	186
400.0163	1	Camshaft locking tool	143
400.0254	1	Locking pin Ø 9.5 mm	60
400.0287	1	Screw M8 x 40,0 mm	18
400.0651	1	Camshaft locking tool (3)	169
400.0652	1	Flywheel TDC indicator	80
400.0653	1	Flywheel locking pin	79
400.0676	1	Camshaft turning tool	7
400.0677	1	Bracket for timing adjustment wrench	111
400.0678	1	Injection pump locking pin	41
400.0679	1	Flywheel TDC locking pin	160

consists of:

KS TOOLS			
X			
400.0680	1	Camshaft locking tool	322
400.0702	1	Flywheel TDC locking pin	205
400.0703	1	Camshaft position (CMP) sensor disc setting tool	102
400.0704	1	Tensioner retaining pin	4
400.0705	1	Tensioner retaining pin	5
400.0753	1	Locking screw M6 x 30,0 mm	10
400.1251	1	Camshaft locking tool	118
400.1254	1	Flywheel locking tool	23
400.1255	1	Camshaft locking tool (2)	56
400.1256	1	Tensioner locking pin	3
400.1260	1	Camshaft locking tool (5)	9
400.1261	4	Locking screw M6 x 10,0 mm	4
400.1262	1	Special tip	10
400.1263	1	Mounting bracket assy	330
400.1264	1	Dial gauge Ø 51 (10 x 0,01 mm)	161
400.1275	1	Camshaft setting strap (TDC)	404
400.9045	1	Flywheel locking tool	80
400.9046	1	Flywheel locking tool	80

**GM / Opel / Saab Fly wheel locking tool**

- For locking the fly wheels
- Secure hold thanks to optimal positioning
- Special steel

**Application range:** Opel and Saab vehicles (1996 - 2005, engine code: Z18XE)

Please carry out an up-to-date cross reference test for the specific vehicle on [www.timingtools.de](http://www.timingtools.de)



KS TOOLS			
400.9046	GM / Opel / Saab Fly wheel locking tool	80	

**GM / Isuzu / Opel / Saab - Camshaft locking tool**

- For the professional engine repair
- Clamping device for a secure hold to change the timing belt
- Aluminium
- Very high degree of accuracy

**Application range:** Opel Tigra 2004 - 2008 (engine code: Z18XE) with 1.8 engines, Frontera, Frontera-B and Sintra-A, Omega-B 1995 - 2004 (engine code: X22SE, X33XE, YE2SE, Y22XE Z22XE) with 2.2 16V engines. Saab 9-3 1996 - 2005 with 1.8 engines (engine code: Z18XE) and similar Isuzu and Saab engines

Please carry out an up-to-date cross reference test for the specific vehicle on [www.timingtools.de](http://www.timingtools.de)

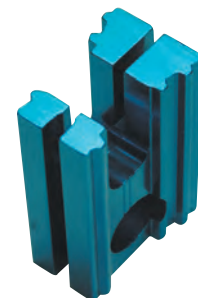

KS TOOLS			
X			
400.0162	1	GM / Isuzu / Opel / Saab - Camshaft locking tool	186

1  
2  
3  
4  
5  
6  
7  
8  
9  
10  
11  
12  
13  
14  
15  
16  
17  
18  
19  
20  
21  
22  
23  
24  
25  
26  
i

## SEAT & ŠKODA

### VAG - Engine Timing Tool Set

- For the professional engine repair
- For locking the crank shaft or cam shaft
- Very high degree of accuracy
- In durable steel storage case

**Application range:** Audi, Seat, Škoda, Volkswagen with 1.4 / 1.6 / 1.8 / 2.0 Turbo / 2.2 / 2.3 / 1.8 / 2.0 16V, 2.6 / 2.8 with petrol engines and 1.0 / 1.2 / 1.3 / 1.4 / 1.9 TDi / 1.7 / 1.9 SDi / 2.5 TDi / 2.8 30V diesel engines

Please carry out an up-to-date cross reference test for the specific vehicle on [www.timingtools.de](http://www.timingtools.de)

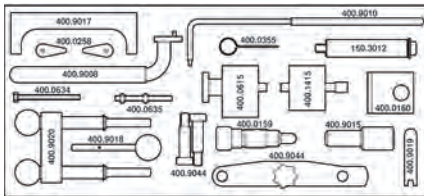
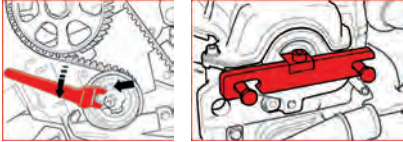

400.2225	19 pcs	VAG - Engine Timing Tool Set	2.23
----------	--------	------------------------------	------

#### consists of:

400.0159	Crankshaft timing pin	120
400.9044	Camshaft setting strap	309
400.9020	Camshaft locking tool	340
400.9019	Tensioner locking tool	20
400.9018	Injection pump locking pin Ø 6.0 mm	20
400.9017	Camshaft setting strap	120
400.9015	Injection pump locking pin Ø 15.4 mm	126
400.9010	Automatic pulley wrench for pin-type face	230
400.9008	Automatic pulley wrench for pin-type face	206
400.1415	Crankshaft pulley setting tool	192
400.0635	Stud and nut M5 x 55.0 mm	8
400.0634	Locking screw M5 x 55.0 mm	8
400.0615	Crankshaft pulley setting tool	190
400.0355	Tensioner pushrod retension pin	1
400.0258	Shim tool (2)	3
400.0160	Camshaft timing tool (2)	118
150.3012	VAG front mask push back	170



### VAG - Engine Timing Tool Set

- For the professional engine repair
- For locking the cam shaft
- For changing the timing belt
- Very high degree of accuracy
- In durable steel storage case

**Application range:** Audi A2 with 1.2, 1.4 TDi engines, A3 with 1.9 TDi engines (> 1996), A3, A4, A6 with 1.9 TDi engines (>1999), Seat Toledo with 1.9 TDi engines (>1999), Škoda Octavia with 1.9 SDi/TDi engines (>1996), Volkswagen Golf, Bora with 1.9 SDi/TDi engines, New Beetle with 1.9 TDi engines (>1997), Lupo with 3L 1.2 TDi, Lupo, Polo 1.4 TDi, Golf, Bora 1.9 TDi engines (>1999)

Please carry out an up-to-date cross reference test for the specific vehicle on [www.timingtools.de](http://www.timingtools.de)

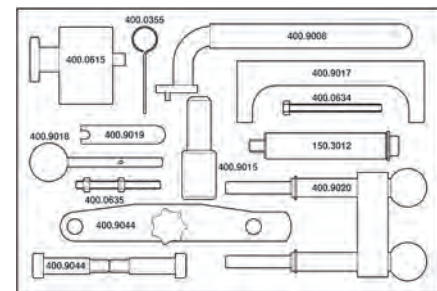
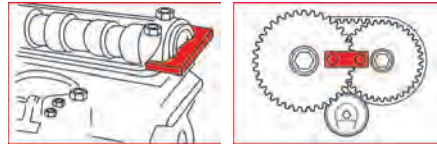

400.0625	12 pcs	VAG - Engine Timing Tool Set	1.73
----------	--------	------------------------------	------

#### consists of:

400.0355	Tensioner pushrod retension pin	1
400.9044	Camshaft setting strap	309
400.9020	Camshaft locking tool	340
400.9019	Tensioner locking tool	20
400.9018	Injection pump locking pin Ø 6.0 mm	20
400.9017	Camshaft setting strap	120
400.9015	Injection pump locking pin Ø 15.4 mm	126
400.9008	Automatic pulley wrench for pin-type face	206
400.0635	Stud and nut M5 x 55.0 mm	8
400.0634	Locking screw M5 x 55.0 mm	8
400.0615	Crankshaft pulley setting tool	190
150.3012	VAG front mask push back	170



### VAG - Engine Timing Tool Set

- For the professional engine repair
- Comprehensive set for locking timing chains
- Very high degree of accuracy
- In durable steel storage case

**Application range:** Audi A3, A4, A6, A8, Škoda Octavia, Volkswagen Polo, Golf, Touran, Passat (engine code: AXW / AXU / BAG / BLF / BKG / BLN / BLP / BUL / BPJ / BGB / BWA / BWE)

Please carry out an up-to-date cross reference test for the specific vehicle on [www.timingtools.de](http://www.timingtools.de)

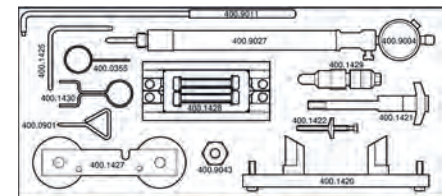
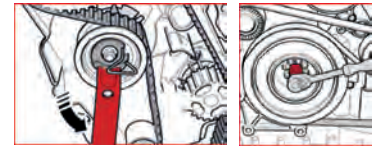

400.2300	17 pcs	VAG - Engine Timing Tool Set	2.83
----------	--------	------------------------------	------

#### consists of:

400.9011	Automatic pulley wrench for pin-type face	259
400.9004	Precision-dial indicator gauge 0 - 10 mm	78
400.9027	TDC determining pin Ø 5.0 mm / dial indicator bracket M14 x 1.25	288
400.0355	Tensioner pushrod retension pin	1
400.1427	Camshaft alignment tool	433
400.1428	Camshaft locking tool (4)	665
400.1429	Crankshaft timing pin	80
400.1430	Timing chain tensioner locking pin	10
400.1421	Chain tensioner retainer	40
400.1422	Chain tensioner retainer	17
400.1420	Camshaft alignment tool	802
400.9043	VAG Crankshaft pulley bolt adaptor	140
400.1425	Tensioning locking pin	11
400.0901	Tensioning locking pin	4



**VAG - Engine Timing Tool Set**

- For the professional engine repair
- For changing the timing belt or the timing chain
- Very high degree of accuracy
- In durable steel storage case

**Application range:** Audi, Seat, Škoda, Volkswagen vehicles including FSI and TFSI engines

Please carry out an up-to-date cross reference test for the specific vehicle on [www.timingtools.de](http://www.timingtools.de)

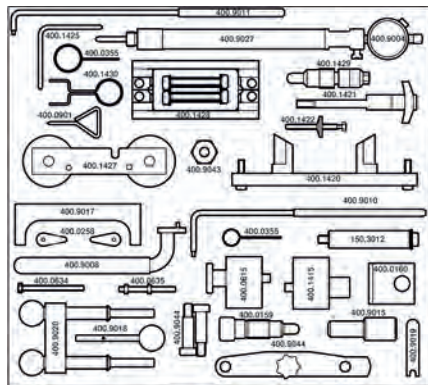
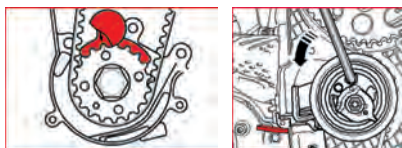

400.1400	35 pcs	VAG - Engine Timing Tool Set	7.94
----------	--------	------------------------------	------

consists of:

Part Number	Description	Quantity
400.0159	Crankshaft timing pin	120
400.9044	Camshaft setting strap	309
400.9043	VAG Crankshaft pulley bolt adaptor	140
400.9027	TDC determining pin Ø 5,0 mm / dial indicator bracket M14 x 1.25	288
400.9020	Camshaft locking tool	340
400.9019	Tensioner locking tool	20
400.9018	Injection pump locking pin Ø 6.0 mm	20
400.9017	Camshaft setting strap	120
400.9015	Injection pump locking pin Ø 15.4 mm	126
400.9011	Automatic pulley wrench for pin-type face	259
400.9010	Automatic pulley wrench for pin-type face	230
400.9008	Automatic pulley wrench for pin-type face	206
400.9004	Precision-dial indicator gauge 0 - 10 mm	78
400.1430	Timing chain tensioner locking pin	10
400.1429	Crankshaft timing pin	80
400.1428	Camshaft locking tool (4)	665
400.1427	Camshaft alignment tool	433
400.1425	Tensioning locking pin	11
400.1422	Chain tensioner retainer	17

consists of:

Part Number	Description	Quantity
400.1421	Chain tensioner retainer	40
400.1420	Camshaft alignment tool	802
400.1415	Crankshaft pulley setting tool	192
400.0901	Tensioning locking pin	4
400.0635	Stud and nut M5 x 55,0 mm	8
400.0634	Locking screw M5 x 55,0 mm	8
400.0615	Crankshaft pulley setting tool	190
400.0355	Tensioner pushrod retension pin	1
400.0258	Shim tool (2)	3
400.0160	Camshaft timing tool (2)	118
150.3012	VAG front mask push back	170

**VAG - Engine Timing Tool Set**

- For the professional engine repair
- For changing the timing belt or the chain
- Very high degree of accuracy
- In durable steel storage case

**Application range:** Audi A3, A4, A5, A6, Q5, Volkswagen Golf, Tiguan, Passat, Eos, Seat Exeo

Please carry out an up-to-date cross reference test for the specific vehicle on [www.timingtools.de](http://www.timingtools.de)

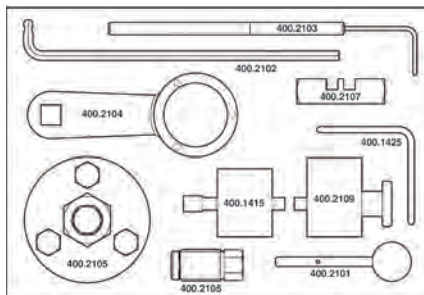
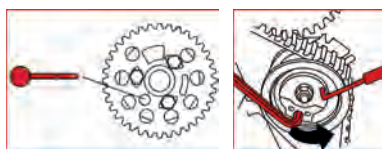

400.2100	9 pcs	VAG - Engine Timing Tool Set	2.61
----------	-------	------------------------------	------

consists of:

Part Number	Description	Quantity
400.1415	Crankshaft pulley setting tool	192
400.1425	Tensioning locking pin	11
400.2101	Injection pump/camshaft alignment pin	14
400.2102	Tensioner adjuster Ø 6.0 mm	20
400.2103	Tensioner adjuster Ø 2.5 mm	216
400.2104	Sprocket holding tool	179
400.2105	Cam sprocket hub puller	581
400.2107	Setting tool	72
400.2109	Crankshaft pulley locking tool (bored)	300

**VAG - Engine Timing Tool Set**

- For the professional engine repair
- For locking the cam shaft
- For changing the timing belt
- Very high degree of accuracy
- In durable steel storage case

**Application range:** Volkswagen Lupo, Polo with 1.2 6V / 12V engines, Seat Cordoba, Ibiza with 1.2 engines (2002-2009), Škoda Fabia II, Roomster with 1.2P engines (engine code: AWY / BMD / AZQ / BME / BZG)

Please carry out an up-to-date cross reference test for the specific vehicle on [www.timingtools.de](http://www.timingtools.de)

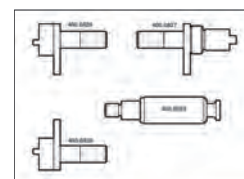
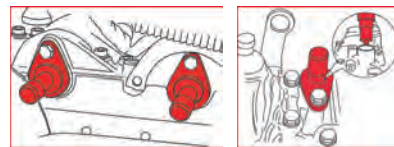

400.0825	4 pcs	VAG - Engine Timing Tool Set	747
----------	-------	------------------------------	-----

consists of:

Part Number	Description	Quantity
400.0826	Camshaft aligning tool 12V (2)	97
400.0827	Camshaft aligning tool 6V	113
400.0828	Crankshaft locking pin 6V/12V	115

**VAG - Engine Timing Tool Set**

- For the professional engine repair
- For locking the cam shaft
- For changing the timing belt
- Very high degree of accuracy
- In durable steel storage case

**Application range:** Volkswagen and other VW Group vehicles 1.4 / 1.6 FSI and 1.4 TSi and 1.2 TFSi / FSi engines

Please carry out an up-to-date cross reference test for the specific vehicle on [www.timingtools.de](http://www.timingtools.de)

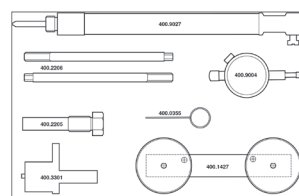
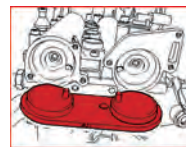

400.3300	8 pcs	VAG - Engine Timing Tool Set	2.14
----------	-------	------------------------------	------

consists of:

400.0355	Tensioner pushrod retension pin	1
400.9027	TDC determining pin Ø 5,0 mm / dial indicator bracket M14 x 1.25	288
400.1427	Camshaft alignment tool	433
400.2205	Crankshaft locking pin	111
400.2206	Crankshaft locking pin (2)	53
400.3301	Camshaft locking tool	174
400.9004	Precision-dial indicator gauge 0 - 10 mm	78

### VAG - Engine Timing Tool Set

- For the professional engine repair
- Expansion set for use alongside 400.2300 / 400.3300
- Very high degree of accuracy
- In durable steel storage case

**Application range:** Audi, Seat, Škoda, Volkswagen vehicles with 1.8 / 2.0 TFSI and FSI engines

Please carry out an up-to-date cross reference test for the specific vehicle on [www.timingtools.de](http://www.timingtools.de)

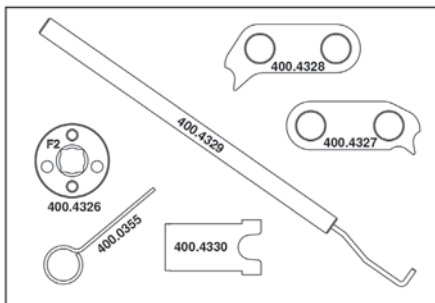
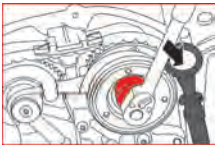

400.4325	7 pcs VAG - Engine Timing Tool Set	1.87

consists of:

400.0355	Tensioner pushrod retension pin	1
400.4326	Cam shaft control valve removal tool	60
400.4327	Cam shaft clamp external	130
400.4328	Cam shaft clamp internal	130
400.4329	Oil pumps securing pin	160
400.4330	Timing chain wrench	30

### VAG / Volvo - Engine Timing Tool Set

- For the professional engine repair
- For locking the crank shaft or cam shaft
- For changing the timing belt
- Very high degree of accuracy

**Application range:** Audi, Seat, Volkswagen, Volvo vehicles

Please carry out an up-to-date cross reference test for the specific vehicle on [www.timingtools.de](http://www.timingtools.de)

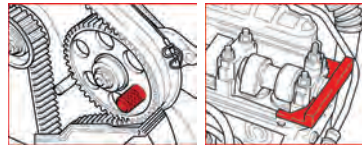

400.1725	2 pcs VAG / Volvo - Engine Timing Tool Set	251

consists of:

400.9015	Injection pump locking pin Ø 15.4 mm	126
400.9017	Camshaft setting strap	120

### VAG Drive pulley wrench 32.0 mm

- For the professional engine repair
- Open 12-point
- For tightening and loosening the automatic timing belt pulley
- With plastic-coated handle
- With suspension hole
- Special steel
- Very high degree of accuracy

**Application range:** Audi 100, A4, A6 TDI 5 cylinder engines, Volkswagen Polo / Lupo from 1999 onwards, LT 2.5 TDI

Please carry out an up-to-date cross reference test for the specific vehicle on [www.timingtools.de](http://www.timingtools.de)

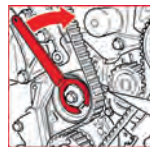

	Suitable for	L mm	Thickness mm	
150.3016	VAG	175.0	3,0	110

### VAG - Engine Timing Tool Set

- For the professional engine repair
- For TDI pump injection engines
- For changing the timing belt
- Secure hold for changing the timing belt or engine repairs

**Application range:** universal usage for many VAG group vehicles, in particular Audi A3, A4, A6, Škoda Octavia 2, Fabia, Volkswagen Golf, Golf Plus, Jetta, Touran, Lupo, Fox, Bora, Beetle, Caddy, Sharan, Passat, Seat Leon, Toledo, Althea, Alhambra with 1.4 / 1.9 / 2.0 TDi engines

Please carry out an up-to-date cross reference test for the specific vehicle on [www.timingtools.de](http://www.timingtools.de)

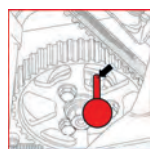

400.2700	7 pcs VAG - Engine Timing Tool Set	455

consists of:

400.0615	Crankshaft pulley setting tool	190
400.0901	Tensioning locking pin	4
400.1415	Crankshaft pulley setting tool	192
400.1425	Tensioning locking pin	11
400.9018	Injection pump locking pin Ø 6.0 mm	20

### VAG Camshaft hub removal tool set

- For the professional engine repair
- Suitable for the simple and correct removal of the cam shaft hub
- Counter hold wrench allows for a precise release or tightening of the cam shaft hub securing screw
- Special steel
- Very high degree of accuracy

**Application range:** Audi, Seat, Škoda and Volkswagen with 1.6 TDI and 2.0 TDI engines

Please carry out an up-to-date cross reference test for the specific vehicle on [www.timingtools.de](http://www.timingtools.de)

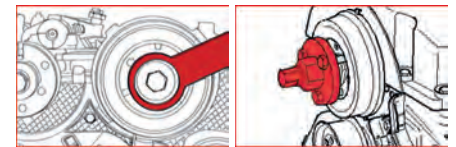

400.2110	2 pcs VAG Camshaft hub removal tool set	760

consists of:

400.2104	Sprocket holding tool	179
400.2105	Cam sprocket hub puller	581

### VAG small tension plate for arresting the automatic pulley

- For the professional engine repair
- Especially designed for fixing the hydraulic timing belt spanner
- Secure hold for changing the timing belt or engine repairs
- Very high degree of accuracy

Please carry out an up-to-date cross reference test for the specific vehicle on [www.timingtools.de](http://www.timingtools.de)

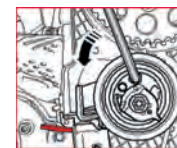

400.9019	VAG small tension plate for arresting the automatic pulley	20

**VAG Camshaft setting bracket**

- For the professional engine repair
- For locking the cam shafts
- Allows for correct engine adjustment
- With central centring screw
- Removal of the valve cover and seal no longer required
- Very high degree of accuracy

**Application range:** Audi A4, Volkswagen Golf, Bora, New Beetle, Seat Ibiza, Cordoba, Alhambra, Inca, Škoda Octavia with 1.9 SDI or TDI engines (engine code: AHF, ALH, ASY, ASV, AGP, AGR, AQM, AHR, AYQ)

Please carry out an up-to-date cross reference test for the specific vehicle on [www.timingtools.de](http://www.timingtools.de)

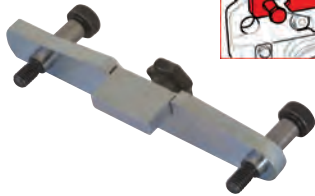
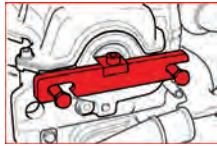

400.9044	VAG Camshaft setting bracket	309
----------	------------------------------	-----

**VAG Camshaft locking device**

- For the professional engine repair
- For locking both cam shaft wheels (TDC setting)
- Secure hold thanks to optimal positioning
- Very high degree of accuracy

**Application range:** VAG 1.4 / 1.6 L petrol engines - Volkswagen Lupo, Polo, Golf IV, Bora, Audi A2, Seat, Škoda etc.

Please carry out an up-to-date cross reference test for the specific vehicle on [www.timingtools.de](http://www.timingtools.de)



150.3034	VAG Camshaft locking device	370
----------	-----------------------------	-----

**VAG Crank shaft locking device**

- For the professional engine repair
- For locking the oval crank shaft timing belt wheel
- Secure hold thanks to optimal positioning
- Very high degree of accuracy

**Application range:** VAG 4 cylinder diesel / Pump injection engines from 2005 onwards and VAG 2.0 I Common Rail diesel engines

Please carry out an up-to-date cross reference test for the specific vehicle on [www.timingtools.de](http://www.timingtools.de)

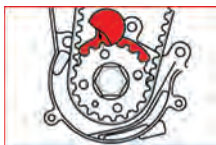

150.3067	VAG Crank shaft locking device	60
----------	--------------------------------	----

**VAG timing chain tensioning wrench**

- For the professional engine repair
- For adjusting the timing chain tension
- For putting on the chain tensioner
- Very high degree of accuracy

**Application:** VAG Group vehicles with 4 valve engines 1.8 and 2.0 TFSI 4 cylinder from the 3rd generation (engine code: CCZA, CCZB, CCZC, CCZD, CDA, CCAB)

Please carry out an up-to-date cross reference test for the specific vehicle on [www.timingtools.de](http://www.timingtools.de)

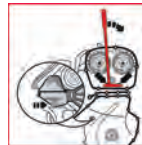

400.4350	VAG timing chain tensioning wrench	562
----------	------------------------------------	-----

**VAG Injection pump locking pin**

- For the professional engine repair
- Ideally suited to securing the injection pump
- With air inlet
- Simple handling
- Special steel
- Very high degree of accuracy

**Application range:** Volkswagen Lupo 3L, 1.2/1.4 TDi, Polo 1.4 TDi, Golf / Bora 1.9 SDi / TDi, Passat 1.9 TD (1994-1996), Beetle 1.9 TDi (>1999) and Transporter 1.9TD

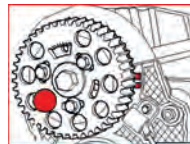

	Suitable for	Ø mm	L mm	g
400.9018	VAG	6,0	80,0	20

**VAG Camshaft adjustment plate**

- For the professional engine repair
- Device for a secure hold to change the timing belt
- For locking the cam shaft
- Secure hold thanks to optimal positioning
- Very high degree of accuracy

**Application:** VAG chain-driven Group vehicles with 2.3 / 2.8 and 2.9 engines, in particular Volkswagen Golf, Bora, Vento, Corrado, Passat, Sharon, Transporter, Seat Toledo

Please carry out an up-to-date cross reference test for the specific vehicle on [www.timingtools.de](http://www.timingtools.de)

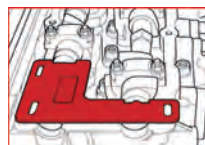

400.9040	VAG Camshaft adjustment plate	57
----------	-------------------------------	----

**VAG 4/3 way cam shaft adjustment tool set**

- For the professional engine repair
- For the installation and removal of the central cam shaft adjustment
- Saves removing the timing chain or removing the engine
- Very high degree of accuracy

**Application range:** VAG Group vehicles 1.8 and 2.0 litre TFSI / TSI engines with timing chains (engine codes: BYT / BZB / CABA / CABB / CABD / CAWB / CBFA / CCA / CCZA / CCZB / CCZC / CDA / CDHA / CDHB / CDB / CDNG / CDND / CFKA / CGYA / CCZA / CCZB / CCZD / CDA / CDABBYT / BZB / CABA / CABB / CABD / CAWB / CBFA / CCA / CCZA / CCZB / CCZC / CDA / CDHA / CDHB / CDB / CDNG / CDND / CFKA / CGYA / CCZA / CCZB / CCZD / CDA / CDABBYT)

Please carry out an up-to-date cross reference test for the specific vehicle on [www.timingtools.de](http://www.timingtools.de)

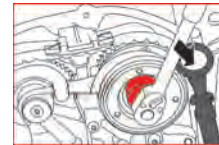

400.9094	2 pcs	VAG 4/3 way cam shaft adjustment tool set	63
----------	-------	---	----

**VAG automatic pulley wrench for pin-type face**

- For tightening and relaxing the timing belt on VAG vehicles
- For pin spacers with driver bores (pin-type face)
- Cranked shape
- With plastic-coated handle

**Application range:** Audi, Volkswagen, Seat, Škoda 4 and 5 cylinder TDI engines, also Volkswagen T4 power steering pumps

Please carry out an up-to-date cross reference test for the specific vehicle on [www.timingtools.de](http://www.timingtools.de)



	Suitable for	L mm	g
400.9008	VAG	140,0	206
400.9009	VAG	210,0	263

**VAG automatic pulley wrench for pin-type face**

- For the professional engine repair
- For tightening and relaxing the timing belt on VAG vehicles
- For pin spacers with driver bores (pin-type face)
- Angled shape
- With plastic-coated handle
- Very high degree of accuracy

**Application range:** Audi, Volkswagen, Seat, Škoda 4 and 5 cylinder TDI engines

Please carry out an up-to-date cross reference test for the specific vehicle on [www.timingtools.de](http://www.timingtools.de)

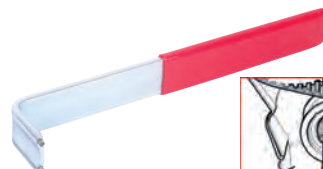

400.9010	VAG automatic pulley wrench for pin-type face	230
----------	---	-----

### VAG automatic pulley wrench for pin-type face

- For tightening and relaxing the timing belt on VAG vehicles
- For pin spacers with driver bores (pin-type face)
- 15° angled
- With plastic-coated handle

**Application range:** Audi, Volkswagen, Seat, Škoda 2,0 FSI/ TDI engines

Please carry out an up-to-date cross reference test for the specific vehicle on [www.timingtools.de](http://www.timingtools.de)



Suitable for		Ø mm	L mm	Weight
400.9011	VAG automatic pulley wrench for pin-type face	259		

### VAG Pin wrench 3 mm, adjustable

- Universal usage
- For the actuation of belt tensioners in VAG
- Phosphate
- Special steel

Please carry out an up-to-date cross reference test for the specific vehicle on [www.timingtools.de](http://www.timingtools.de)



Suitable for		Ø mm	L mm	Weight
150.3018	VAG	9,0-45,0	150,0	100

### VAG automatic pulley wrench for pin-type face

- For tightening and relaxing the timing belt on VAG vehicles
- 180° adjustable handle
- For pin spacers with tappet tolerances
- Normal and extra flat ideal for hard to access areas
- With plastic coated handle

**Application range:** VAG 4 and 5 cylinder TDI-Model, T4 Servo pump



Suitable for		L mm	Stud Ø mm	Pin key mm	Weight
500.4315	VAG	180,0	3,0	18,0	95
150.3017	VAG	185,0	3,0	18,0	105

### VAG V belt and timing belt wrench

- For loosening the automatic clamping device
- Problem free changing of the belt
- For hard to reach places
- With plastic-coated handle
- Chrome vanadium

**Application range:** Audi, Seat, Škoda and Volkswagen with 2.0 TDI and 1.4 TSI engines

**Volkswagen Beetle** (2011-2013), Eos (2007-2013), Golf (2003-2008), Golf (>2008), Golf Estate (2007-2009), Golf Estate (>2009), Gold Plus (2005-2009), Golf Plus (>2009), Golf VI Cabrio (>2011), Jetta (2005-2011), Jetta (>2011), Scirocco (>2008), Passat (2005-2011), Passat (>2011), Tiguan (2010-2013), Polo (>2009), Touran (2007-2013), **Audi A1** (2010-2013), **Škoda Octavia** (>2004), Yeti (2010-2013), engine code: CAVD, CAXA, CAVB, CAVC



Suitable for		Ø mm	Length mm	Weight
400.4300	VAG	16	380,0	501

### VAG Engine support socket set, extra short

- 12-point
- For the assembly and removal of the aluminium engine support (hard to reach sites)
- Ideal for timing belt change
- Internal square drive to DIN 3120 / ISO 1174 with ball reception
- Extra-short design
- For manual operation
- Matt finish
- Chrome vanadium

**Application range:** For timing belt change on Volkswagen Golf IV, Audi, Škoda, Seat etc.



Suitable for		Weight
911.1295	2 pcs VAG Engine support socket set, extra short	110

consists of:

Suitable for		Weight
911.1293	12 point socket, 16,0 mm short	40
911.1294	12 point socket, 16,0 mm long	67

### Hexagon socket, long for pulley wheel

- Suited for the assembly and disassembly of the pulley wheel vibration damper, e.g. when changing the timing belt
- 6-point
- FlankTraction-Profile
- In accordance with DIN 3124 / ISO 2725
- Internal square to DIN 3120 / ISO 1174 with ball reception
- Long design
- For manual operation
- Matt finish
- Chrome vanadium

**Application range:** Audi, Seat, Škoda and Volkswagen

Please carry out an up-to-date cross reference test for the specific vehicle on [www.timingtools.de](http://www.timingtools.de)



Suitable for		D1 mm	D2 mm	L mm	T mm	Weight
917.1254		27,0	34,0	36,0	76,0	19,0

### Bit socket for spline (XZN®) screws, long

- Ideal for releasing and tightening of the securing screws of the high-pressure pumps, timing belt wheels, e.g. when changing timing belt
- Spline (XZN®)
- Internal square drive to DIN 3120 / ISO 1174 with ball reception
- Long design
- With press fitted nickel plated insert bit
- For manual operation
- Matt finish
- Chrome vanadium

**Application range:** Audi, Seat, Škoda and Volkswagen with TDI Common Rail engines, engine code: CAAA, CAAB, CAAC, CAYB, CBAA, CBAB, CBBB etc.

Please carry out an up-to-date cross reference test for the specific vehicle on [www.timingtools.de](http://www.timingtools.de)



Suitable for		D mm	L mm	T mm	Weight
911.1353	M10	22,0	110,0	72,0	112

### VAG Bit socket for hexagon screws, extra long

- Hexagon socket with ball head
- For releasing and tightening the TDC sensor
- Internal square drive to DIN 3120 / ISO 1174 with ball reception
- Extra-long design
- For manual operation
- Matt finish
- Chrome vanadium

**Application range:** VAG models from 2005, 4-cylinder 2.0l diesel engines



Suitable for		Ø mm	D mm	L mm	Weight
911.1598		4,0	11,0	300,0	80



**VOLKSWAGEN**

**VAG - Engine Timing Tool Set**

- For the professional engine repair
- For locking the crank shaft or cam shaft
- Very high degree of accuracy
- In durable steel storage case

**Application range:** Audi, Seat, Škoda, Volkswagen with 1.4 / 1.6 / 1.8 / 2.0 Turbo / 2.2 / 2.3 / 1.8 / 2.0 16V, 2.6 / 2.8 with petrol engines and 1.0 / 1.2 / 1.3 / 1.4 / 1.9 TDi / 1.7 / 1.9 SDi / 2.5 TDi / 2.8 30V diesel engines

Please carry out an up-to-date cross reference test for the specific vehicle on [www.timingtools.de](http://www.timingtools.de)

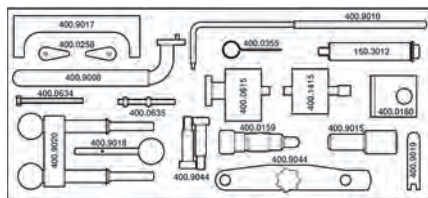
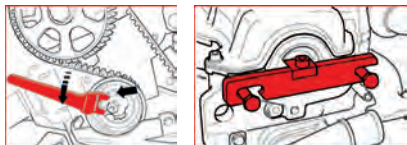

<b>400.2225</b>	19 pcs	VAG - Engine Timing Tool Set	2.23
-----------------	--------	------------------------------	------

consists of:

<b>400.0159</b>	Crankshaft timing pin	120
<b>400.9044</b>	Camshaft setting strap	309
<b>400.9020</b>	Camshaft locking tool	340
<b>400.9019</b>	Tensioner locking tool	20
<b>400.9018</b>	Injection pump locking pin Ø 6.0 mm	20
<b>400.9017</b>	Camshaft setting strap	120
<b>400.9015</b>	Injection pump locking pin Ø 15.4 mm	126
<b>400.9010</b>	Automatic pulley wrench for pin-type face	230
<b>400.9008</b>	Automatic pulley wrench for pin-type face	206
<b>400.1415</b>	Crankshaft pulley setting tool	192
<b>400.0635</b>	Stud and nut M5 x 55.0 mm	8
<b>400.0634</b>	Locking screw M5 x 55.0 mm	8
<b>400.0615</b>	Crankshaft pulley setting tool	190
<b>400.0355</b>	Tensioner pushrod retension pin	1
<b>400.0258</b>	Shim tool (2)	3
<b>400.0160</b>	Camshaft timing tool (2)	118
<b>150.3012</b>	VAG front mask push back	170



**VAG - Engine Timing Tool Set**

- For the professional engine repair
- For locking the cam shaft
- For changing the timing belt
- Very high degree of accuracy
- In durable steel storage case

**Application range:** Audi A2 with 1.2, 1.4 TDi engines, A3 with 1.9 TDi engines (> 1996), A3, A4, A6 with 1.9 TDi engines (>1999), Seat Toledo with 1.9 TDi engines (>1999), Škoda Octavia with 1.9 SDi/TDi engines (>1996), Volkswagen Golf, Bora with 1.9 SDi/TDi engines, New Beetle with 1.9 TDi engines (>1997), Lupo with 3L 1.2 TDi, Polo 1.4 TDi, Golf, Bora 1.9 TDi engines (>1999)

Please carry out an up-to-date cross reference test for the specific vehicle on [www.timingtools.de](http://www.timingtools.de)

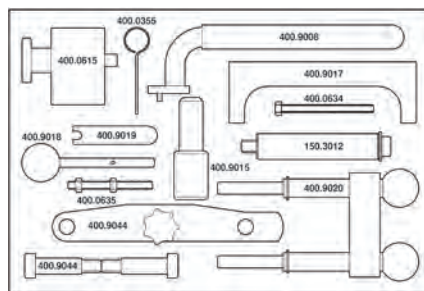
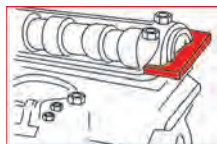

<b>400.0625</b>	12 pcs	VAG - Engine Timing Tool Set	1.73
-----------------	--------	------------------------------	------

consists of:

<b>400.0355</b>	Tensioner pushrod retension pin	1
<b>400.9044</b>	Camshaft setting strap	309
<b>400.9020</b>	Camshaft locking tool	340
<b>400.9019</b>	Tensioner locking tool	20
<b>400.9018</b>	Injection pump locking pin Ø 6.0 mm	20
<b>400.9017</b>	Camshaft setting strap	120
<b>400.9015</b>	Injection pump locking pin Ø 15.4 mm	126
<b>400.9008</b>	Automatic pulley wrench for pin-type face	206
<b>400.0635</b>	Stud and nut M5 x 55.0 mm	8
<b>400.0634</b>	Locking screw M5 x 55.0 mm	8
<b>400.0615</b>	Crankshaft pulley setting tool	190
<b>150.3012</b>	VAG front mask push back	170

**VAG - Engine Timing Tool Set**

- For the professional engine repair
- Comprehensive set for locking timing chains
- Very high degree of accuracy
- In durable steel storage case

**Application range:** Audi A3, A4, A6, A8, Škoda Octavia, Volkswagen Polo, Golf, Touran, Passat (engine code: AXW / AXU / BAG / BLF / BKG / BLN / BLP / BUL / BPU / BGB / BWA / BWE)

Please carry out an up-to-date cross reference test for the specific vehicle on [www.timingtools.de](http://www.timingtools.de)

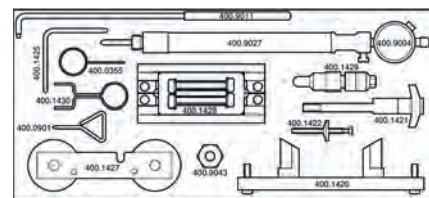
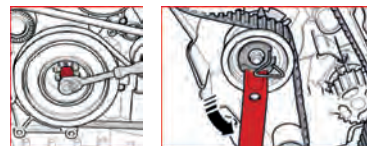

<b>400.2300</b>	17 pcs	VAG - Engine Timing Tool Set	2.83
-----------------	--------	------------------------------	------

consists of:

<b>400.0355</b>	Tensioner pushrod retension pin	1
<b>400.0901</b>	Tensioning locking pin	4
<b>400.1420</b>	Camshaft alignment tool	802
<b>400.1421</b>	Chain tensioner retainer	40
<b>400.1422</b>	Chain tensioner retainer	17
<b>400.1425</b>	Tensioning locking pin	11
<b>400.1427</b>	Camshaft alignment tool	433
<b>400.1428</b>	Camshaft locking tool (4)	665
<b>400.1429</b>	Crankshaft timing pin	80
<b>400.1430</b>	Timing chain tensioner locking pin	10
<b>400.9004</b>	Precision-dial indicator gauge 0 - 10 mm	78
<b>400.9011</b>	Automatic pulley wrench for pin-type face	259
<b>400.9027</b>	TDC determining pin Ø 5.0 mm / dial indicator bracket M14 x 1.25	288
<b>400.9043</b>	VAG Crankshaft pulley bolt adaptor	140

**VAG - Engine Timing Tool Set**

- For the professional engine repair
- For chain-driven engines
- Very high degree of accuracy
- In durable steel storage case

**Application range:** Audi A3, Volkswagen Polo, Golf, Jetta, Passat, Eos, Tiguan, Touran (engine code: AXU / BAG / BKG / BLF / BLN / BLP / BMY / BWK / CAXA)

Please carry out an up-to-date cross reference test for the specific vehicle on [www.timingtools.de](http://www.timingtools.de)

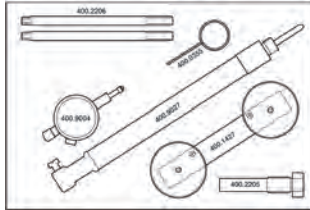
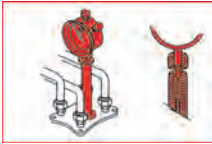

400.2200	7 pcs	VAG - Engine Timing Tool Set	2.11
----------	-------	------------------------------	------

consists of:

400.1427	Camshaft alignment tool	433
400.9027	TDC determining pin Ø 5,0 mm / dial indicator bracket M14 x 1.25	288
400.9004	Precision-dial indicator gauge 0 - 10 mm	78
400.2206	Crankshaft locking pin (2)	53
400.2205	Crankshaft locking pin	111
400.0355	Tensioner pushrod retension pin	1

**VAG - Engine Timing Tool Set**

- For the professional engine repair
- For locking the crank shaft or cam shaft
- Very high degree of accuracy
- In durable steel storage case

**Application range:** Audi vehicles with V6, V8, V10 FSI engines

Please carry out an up-to-date cross reference test for the specific vehicle on [www.timingtools.de](http://www.timingtools.de)

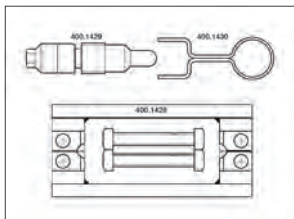
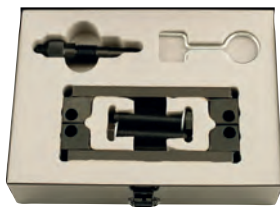

400.2250	6 pcs	VAG - Engine Timing Tool Set	899
----------	-------	------------------------------	-----

consists of:

400.1428	Camshaft locking tool (4)	665
400.1429	Crankshaft timing pin	80
400.1430	Timing chain tensioner locking pin	10

**Ford / VAG - Engine Timing Tool Set**

- For the professional engine repair
- For locking the cam shaft
- For changing the timing belt or the chain
- Very high degree of accuracy
- In durable steel storage case

**Application range:** Ford vehicles with TDDi / TDCi and Duratorq engines and Ford Galaxy with similar engines to Volkswagen

Please carry out an up-to-date cross reference test for the specific vehicle on [www.timingtools.de](http://www.timingtools.de)

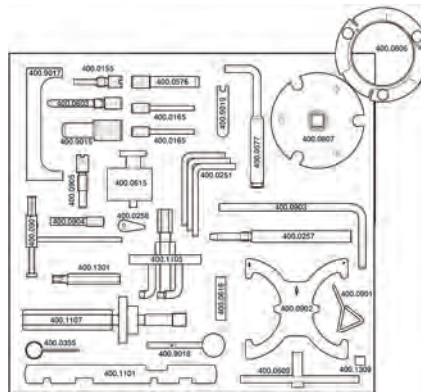
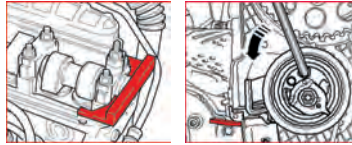

400.1300	31 pcs	Ford / VAG - Engine Timing Tool Set	6.68
----------	--------	-------------------------------------	------

consists of:

400.0155	Crankshaft timing pin	240
400.0165	Camshaft locking pin 5.0 mm	19
400.0251	Injection pump locking pin Ø 6.0 mm	30
400.0257	Crankshaft TDC locking pin	124
400.0258	Shim tool (2)	3
400.0355	Tensioner pushrod retension pin	1
400.0576	Flywheel locking pin	64
400.0577	Flywheel locking tool	124
400.0603	Crankshaft timing pin	51
400.0609	Flywheel locking tool	308
400.0615	Crankshaft pulley setting tool	190
400.0616	Flywheel locking adaptor	74
400.0806	Locking tool	45

consists of:

400.0807	Pump cover locking tool	2
400.0901	Tensioning locking pin	4
400.0902	Camshaft locking tool	384
400.0903	Crankshaft locking pin	85
400.0904	Camshaft/injection pump locking pin	26
400.0905	Crankshaft locking pin	33
400.1101	Camshaft setting strap	140
400.1105	Camshaft sprocket puller	552
400.1106	Fuel sprocket remover	80
400.1107	Chain cover alignment tool	497
400.1301	TX T45 bit	31
400.1309	Flywheel locking adaptor	13
400.9015	Injection pump locking pin Ø 15.4 mm	126
400.9017	Camshaft setting strap	120
400.9018	Injection pump locking pin Ø 6.0 mm	20
400.9019	Tensioner locking tool	20

**VAG - Engine Timing Tool Set**

- For the professional engine repair
- For locking the cam shaft
- For changing the timing chain
- Very high degree of accuracy
- In durable steel storage case

**Application range:** Audi A4 (2005-2009) with 2.7 TDI engine, A4 Quattro (2005-2006) with 2.0 TDI engine, Q7 with 3.0 TDI engine, Volkswagen Touareg (>2008), Phaeton (>2006) with 3.0 TDi V6 engine (engine code: BPP / BMZ / BUG / BUN)

Please carry out an up-to-date cross reference test for the specific vehicle on [www.timingtools.de](http://www.timingtools.de)

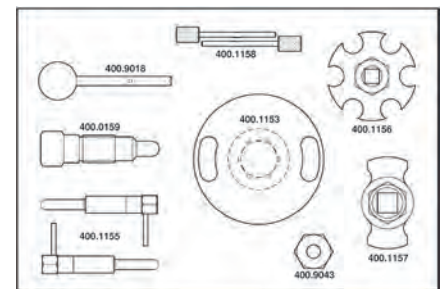
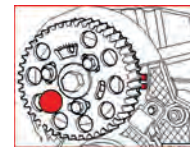

400.1150	10 pcs	VAG - Engine Timing Tool Set	2.41
----------	--------	------------------------------	------

consists of:

400.0159	Crankshaft timing pin	120
400.1153	Crankshaft turning tool	354
400.1155	Camshaft locking pin (2)	47
400.1156	Camshaft alignment/locking tool	366

consists of:

		
400.1157	Camshaft sprocket holding tool	120
400.1158	Timing pin Ø 3,3 mm (2)	12
400.9018	Injection pump locking pin Ø 6.0 mm	20
400.9043	VAG Crankshaft pulley bolt adaptor	140

**VAG - Engine Timing Tool Set**

- For the professional engine repair
- Especially for timing wheel-driven vehicles
- For adjusting the injection adjuster via the cam shaft follower
- Very high degree of accuracy
- In durable steel storage case

**Application range:** Volkswagen Touareg, Transporter (> 2003) with 2.5 TDI engines (engine code: BAC / BLK / BPD / AXD / AXE / BLJ / BNZ / BPC) and 4.9D / TDI (engine code: AYH)

Please carry out an up-to-date cross reference test for the specific vehicle on [www.timingtools.de](http://www.timingtools.de)

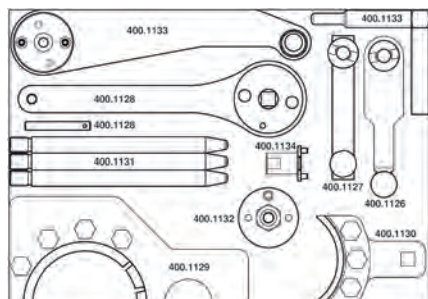
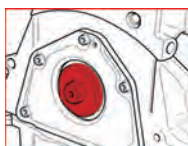

		
400.1125	12 pcs VAG - Engine Timing Tool Set	9.45

consists of:

		
400.1126	Camshaft locking tool	226
400.1127	Camshaft locking tool	174
400.1128	Crankshaft timing tool (2)	1194
400.1129	Camshaft gear retaining tool (big)	2769
400.1130	Camshaft gear retaining tool (small)	677
400.1131	Guide pin set (3)	769
400.1132	Crankshaft turning tool (TDC-cylinder 1)	141
400.1133	Crankshaft alignment tool (TDC-cylinder 1)	998
400.1134	Camshaft compensation gear pre-tensioning tool	75

**VAG - Engine Timing Tool Set**

- For the professional engine repair
- For changing the timing belt or the timing chain
- Very high degree of accuracy
- In durable steel storage case

**Application range:** Audi, Seat, Škoda, Volkswagen vehicles including FSI and TFSI engines

Please carry out an up-to-date cross reference test for the specific vehicle on [www.timingtools.de](http://www.timingtools.de)

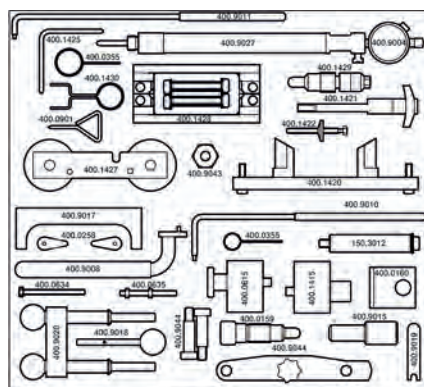
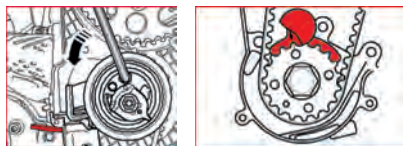

		
400.1400	35 pcs VAG - Engine Timing Tool Set	7.94

consists of:

		
400.0159	Crankshaft timing pin	120
400.9044	Camshaft setting strap	309
400.9043	VAG Crankshaft pulley bolt adaptor	140
400.9027	TDC determining pin Ø 5,0 mm / dial indicator bracket M14 x 1,25	288
400.9020	Camshaft locking tool	340
400.9019	Tensioner locking tool	20
400.9018	Injection pump locking pin Ø 6.0 mm	20
400.9017	Camshaft setting strap	120
400.9015	Injection pump locking pin Ø 15.4 mm	126
400.9011	Automatic pulley wrench for pin-type face	259
400.9010	Automatic pulley wrench for pin-type face	230
400.9008	Automatic pulley wrench for pin-type face	206
400.9004	Precision-dial indicator gauge 0 - 10 mm	78
400.1430	Timing chain tensioner locking pin	10
400.1429	Crankshaft timing pin	80
400.1428	Camshaft locking tool (4)	665
400.1427	Camshaft alignment tool	433
400.1425	Tensioning locking pin	11

consists of:

		
400.1422	Chain tensioner retainer	17
400.1421	Chain tensioner retainer	40
400.1420	Camshaft alignment tool	802
400.1415	Crankshaft pulley setting tool	192
400.0901	Tensioning locking pin	4
400.0635	Stud and nut M5 x 55,0 mm	8
400.0634	Locking screw M5 x 55,0 mm	8
400.0615	Crankshaft pulley setting tool	190
400.0355	Tensioner pushrod retension pin	1
400.0258	Shim tool (2)	3
400.0160	Camshaft timing tool (2)	118
150.3012	VAG front mask push back	170

**VAG - Engine Timing Tool Set**

- For the professional engine repair
- For changing the timing belt or the chain
- Very high degree of accuracy
- In durable steel storage case

**Application range:** Audi A3, A4, A5, A6, Q5, Volkswagen Golf, Tiguan, Passat, Eos, Seat Exeo

Please carry out an up-to-date cross reference test for the specific vehicle on [www.timingtools.de](http://www.timingtools.de)

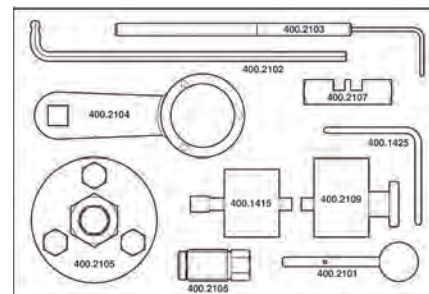
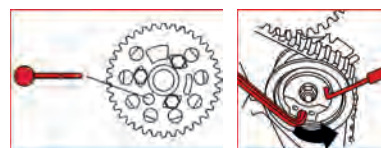

		
400.2100	9 pcs VAG - Engine Timing Tool Set	2.61

consists of:

		
400.1415	Crankshaft pulley setting tool	192
400.1425	Tensioning locking pin	11
400.2101	Injection pump/camshaft alignment pin	14
400.2102	Tensioner adjuster Ø 6.0 mm	20
400.2103	Tensioner adjuster Ø 2.5 mm	216
400.2104	Sprocket holding tool	179
400.2105	Cam sprocket hub puller	581
400.2107	Setting tool	72
400.2109	Crankshaft pulley locking tool (bored)	300

### VAG - Engine Timing Tool Set

- For the professional engine repair
- For timing wheel-driven engines
- Very high degree of accuracy
- In durable steel storage case

**Application range:** Volkswagen Touareg, Transporter (engine code: AXE / AXD / BAC / BLK / BLJ / BNZ / BPC / BPE / BPD)

Please carry out an up-to-date cross reference test for the specific vehicle on [www.timingtools.de](http://www.timingtools.de)

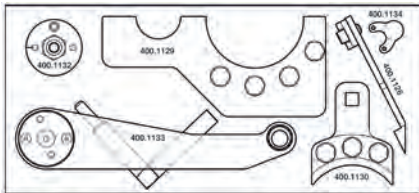
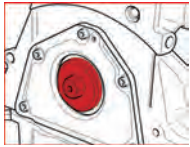

400.2500	6 pcs	VAG - Engine Timing Tool Set	6.50
----------	-------	------------------------------	------

consists of:

400.1126	Camshaft locking tool	226
400.1129	Camshaft gear retaining tool (big)	2769
400.1130	Camshaft gear retaining tool (small)	677
400.1132	Crankshaft turning tool (TDC-cylinder 1)	141
400.1133	Crankshaft alignment tool (TDC-cylinder 1)	998
400.1134	Camshaft compensation gear pre-tensioning tool	75

### VAG - Engine Timing Tool Set

- For the professional engine repair
- For locking the cam shaft
- For changing the timing belt
- Very high degree of accuracy
- In durable steel storage case

**Application range:** Volkswagen Lupo, Polo with 1.2 6V / 12V engines, Seat Cordoba, Ibiza with 1.2 engines (2002-2009), Škoda Fabia II, Roomster with 1.2P engines (engine code: AWY / BMD / AZQ / BME / BZG)

Please carry out an up-to-date cross reference test for the specific vehicle on [www.timingtools.de](http://www.timingtools.de)

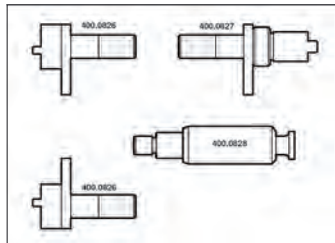
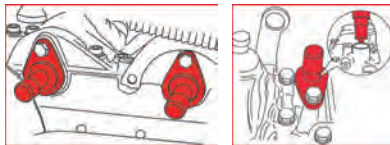

400.0825	4 pcs	VAG - Engine Timing Tool Set	747
----------	-------	------------------------------	-----

consists of:

400.0826	Camshaft aligning tool 12V (2)	97
400.0827	Camshaft aligning tool 6V	113
400.0828	Crankshaft locking pin 6V/12V	115

### VAG - Engine Timing Tool Set

- For the professional engine repair
- For locking the cam shaft
- For changing the timing belt
- Very high degree of accuracy
- In durable steel storage case

**Application range:** Volkswagen and other VW Group vehicles 1.4 / 1.6 FSI and 1.4 TSi and 1.2 TFSi / FSI engines

Please carry out an up-to-date cross reference test for the specific vehicle on [www.timingtools.de](http://www.timingtools.de)

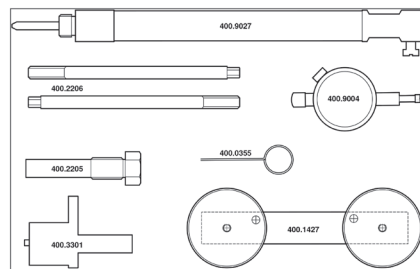
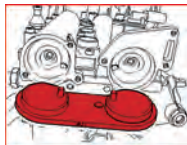

400.3300	8 pcs	VAG - Engine Timing Tool Set	2.14
----------	-------	------------------------------	------

consists of:

400.0355	Tensioner pushrod retention pin	1
400.9027	TDC determining pin Ø 5,0 mm / dial indicator bracket M14 x 1.25	288
400.1427	Camshaft alignment tool	433
400.2205	Crankshaft locking pin	111
400.2206	Crankshaft locking pin (2)	53
400.3301	Camshaft locking tool	174
400.9004	Precision-dial indicator gauge 0 - 10 mm	78

### VAG - Engine Timing Tool Set

- For the professional engine repair
- Expansion set for use alongside 400.2300 / 400.3300
- Very high degree of accuracy
- In durable steel storage case

**Application range:** Audi, Seat, Škoda, Volkswagen vehicles with 1.8 / 2.0 TFSI and FSI engines

Please carry out an up-to-date cross reference test for the specific vehicle on [www.timingtools.de](http://www.timingtools.de)

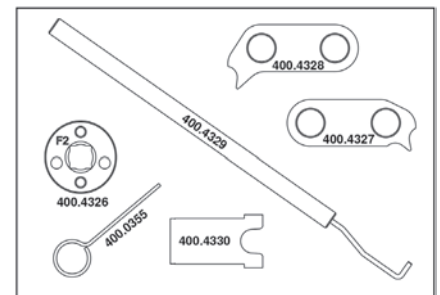
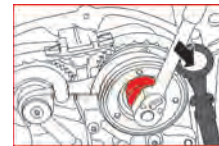

400.4325	7 pcs	VAG - Engine Timing Tool Set	1.87
----------	-------	------------------------------	------

consists of:

400.0355	Tensioner pushrod retention pin	1
400.4326	Cam shaft control valve removal tool	60
400.4327	Cam shaft clamp external	130
400.4328	Cam shaft clamp internal	130
400.4329	Oil pumps securing pin	160
400.4330	Timing chain wrench	30



**VAG - Engine Timing Tool Set**

- For the professional engine repair
- Necessary to separate the V6 2 valve engine cam shafts from each other
- Very high degree of accuracy

**Application range:** Audi 80 (1991-2002) with 2.6 / 2.8 engines, A4 with 2.6 / 2.8 engines, 100 with 2.6 / 2.8 engines, A8 with 2.8 engines, Cabrio, Coupe with 2.6 / 2.8 engines (engine code: AAH, ABC)

Please carry out an up-to-date cross reference test for the specific vehicle on [www.timingtools.de](http://www.timingtools.de)

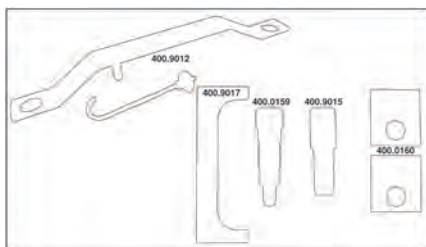
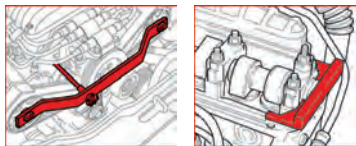

400.0225	6 pcs	VAG - Engine Timing Tool Set	3.02
----------	-------	------------------------------	------

consists of:

400.0159	Crankshaft timing pin	120
400.0160	Camshaft timing tool (2)	118
400.9012	Camshaft locking tool	2012
400.9015	Injection pump locking pin Ø 15.4 mm	126
400.9017	Camshaft setting strap	120

**VAG Camshaft fixing tool**

- For the professional engine repair
- For locking the cam shafts
- Allows for correct engine adjustment
- Very high degree of accuracy

**Application range:** Audi 80, 90, A4, A6, A8 with 2.6 V6 12V engines (engine code: ABC, ACZ) and with 2.8 V6 12V engines (AAH, AEJ)

Please carry out an up-to-date cross reference test for the specific vehicle on [www.timingtools.de](http://www.timingtools.de)

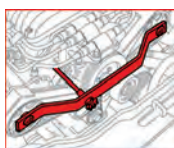

400.9012	VAG Camshaft fixing tool	2.01
----------	--------------------------	------

**VAG Camshaft fixing tool**

- For the professional engine repair
- For locking the cam shafts
- Allows for correct engine adjustment
- Very high degree of accuracy

**Application range:** Audi A4 2.4 and 2.8 1997-2002, A6 2.4 1997-2002, A6 2.8 1997-2002, A8 2.8 1997-2002, S4 2.7 Turbo 1997-2001 and Volkswagen Passat 2.4 1996-2002, Passat 2.8 30V 1996-2001 (engine code: ACK, ALG, APR, AQD)

Please carry out an up-to-date cross reference test for the specific vehicle on [www.timingtools.de](http://www.timingtools.de)



400.9013	VAG Camshaft fixing tool	2.41
----------	--------------------------	------

**VAG - Engine Timing Tool Set**

- For the professional engine repair
- Range for changing timing belts or for working on timing devices
- Very high degree of accuracy
- In durable steel storage case

**Application range:** VAG group vehicles with 2.4 engines, in particular Volkswagen T2, T3, T4 Transporter, LT, Golf, Passat and Audi (engine code: AAB, AJA, ADG, ABL, 1X, 1Y, 1W, 1V, CS, CW, KY, JR, JX, JD, JP, 1Z, AAT, AEL, AAZ, AHU, AFN, AEY, AVG, ALE, AFF, AHH, ACV, AHY, AJT, AUF, AXG, AXL, AYC)

Please carry out an up-to-date cross reference test for the specific vehicle on [www.timingtools.de](http://www.timingtools.de)

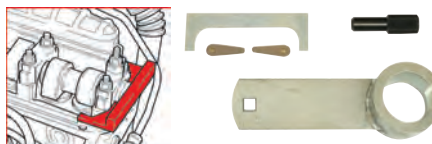

400.2125	5 pcs	VAG - Engine Timing Tool Set	951
----------	-------	------------------------------	-----

consists of:

400.0258	Shim tool (2)	3
400.9015	Injection pump locking pin Ø 15.4 mm	126
400.9017	Camshaft setting strap	120
400.9042	Pulley wheel counter hold wrench	714

**VAG pulley wheel counter hold wrench**

- For the professional engine repair
- Simple assembly and disassembly of the crank shaft pulley wheel or vibration dampers
- Special profiles allows for counter holding when releasing or securing the crank shaft central screw
- The handle can be lengthened via the 3/4" internal square
- Very high degree of accuracy

**Application range:** VAG group vehicles with 2.4 engines, in particular Volkswagen T2, T3, T4 Transporter, LT, Golf, Passat and Audi (engine code: AAB, AJA, ADG, ABL, 1X, 1Y, 1W, 1V, CS, CW, KY, JR, JX, JD, JP, 1Z, AAT, AEL, AAZ, AHU, AFN, AEY, AVG, ALE, AFF, AHH, ACV, AHY, AJT, AUF, AXG, AXL, AYC)

Please carry out an up-to-date cross reference test for the specific vehicle on [www.timingtools.de](http://www.timingtools.de)



400.9042	VAG pulley wheel counter hold wrench	714
----------	--------------------------------------	-----

**VAG Camshaft ruler**

- For the professional engine repair
- Ideally suited to fixing the cam shaft
- Simple handling
- Special steel
- Very high degree of accuracy

**Application range:** VAG group vehicles with diesel engines, in particular Volkswagen T2, T3, T4, LT, Golf, Passat, Audi with 2.4D 6 cylinder and 2.4 TD 5 cylinder TDI engines, as well as all older diesel engines such as 1.6 D and 1.7 D GTD (engine code: CS, CW, JD, JX, JP, JR, 1X, 1Y, 1Z, KY, AAZ, AAT, AEL, AFN, AFF, AHU, AHH, AVG, AAB, AJA, AHY)

Please carry out an up-to-date cross reference test for the specific vehicle on [www.timingtools.de](http://www.timingtools.de)

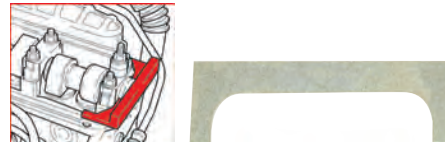

400.9017	VAG Camshaft ruler	120
----------	--------------------	-----

**VAG fixing pin injection pump wheel**

- For the professional engine repair
- Ideally suited to securing the injection pump
- Simple handling
- Special steel
- Very high degree of accuracy

**Application range:** VAG group vehicles with diesel engines, in particular Volkswagen T2, T3, T4, LT, Golf, Passat, Audi with 2.4D 6 cylinder and 2.4 TD 5 cylinder TDI engines, as well as all older diesel engines such as 1.6 D and 1.7 D GTD (engine code: CS, CW, JD, JX, JP, JR, 1X, 1Y, 1Z, KY, AAZ, AAT, AEL, AFN, AFF, AHU, AHH, AVG, AAB, AJA, AHY)

Please carry out an up-to-date cross reference test for the specific vehicle on [www.timingtools.de](http://www.timingtools.de)

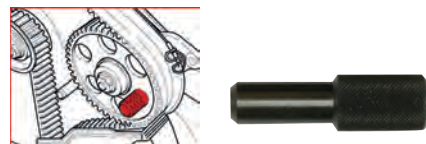

	Suitable for	Ø mm	Length mm	
400.9015	VAG	15,4	67,0	126

**VAG / Volvo - Engine Timing Tool Set**

- For the professional engine repair
- For locking the crank shaft or cam shaft
- For changing the timing belt
- Very high degree of accuracy

**Application range:** Audi, Seat, Volkswagen, Volvo vehicles

Please carry out an up-to-date cross reference test for the specific vehicle on [www.timingtools.de](http://www.timingtools.de)

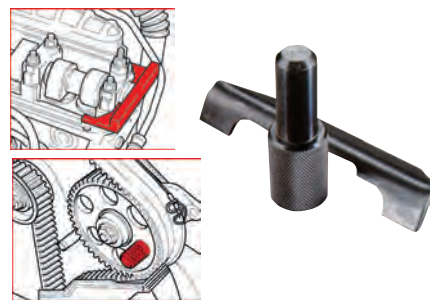

400.1725	2 pcs	VAG / Volvo - Engine Timing Tool Set	251
----------	-------	--------------------------------------	-----

consists of:

400.9015	Injection pump locking pin Ø 15.4 mm	126
400.9017	Camshaft setting strap	120

### VAG - Engine Timing Tool Set

- For the professional engine repair
- For locking the cam shaft
- For changing the timing belt
- Very high degree of accuracy

**Application range:** Volkswagen Crafter (2006-2009) with 2.5 TDi engine (engine code: BJJ / BJK / BJL / BJM)

Please carry out an up-to-date cross reference test for the specific vehicle on [www.timingtools.de](http://www.timingtools.de)

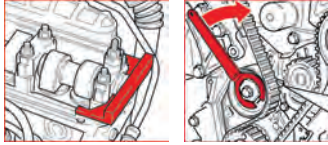

🔧			
400.0975	5 pcs	VAG - Engine Timing Tool Set	255

**consists of:**

🔧			
150.3016	Drive pulley wrench, 32, 175mm	110	
400.0258	Shim tool (2)	3	
400.0978	Crankshaft timing pin	103	
400.9017	Camshaft setting strap	120	

### VAG Drive pulley wrench 32.0 mm

- For the professional engine repair
- Open 12-point
- For tightening and loosening the automatic timing belt pulley
- With plastic-coated handle
- With suspension hole
- Special steel
- Very high degree of accuracy

**Application range:** Audi 100, A4, A6 TDi 5 cylinder engines, Volkswagen Polo / Lupo from 1999 onwards, LT 2.5 TDi

Please carry out an up-to-date cross reference test for the specific vehicle on [www.timingtools.de](http://www.timingtools.de)

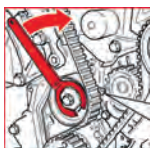

Suitable for	🔧	L mm	Thickness mm	🔧	
150.3016	VAG	32,0	175,0	3,0	110

### VAG - Engine Timing Tool Set

- For the professional engine repair
- For TDi pump injection engines
- For changing the timing belt
- Secure hold for changing the timing belt or engine repairs

**Application range:** universal usage for many VAG group vehicles, in particular Audi A3, A4, A6, Škoda Octavia 2, Fabia, Volkswagen Golf, Golf Plus, Jetta, Touran, Lupo, Fox, Bora, Beetle, Caddy, Sharan, Passat, Seat Leon, Toledo, Althea, Alhambra with 1.4 / 1.9 / 2.0 TDi engines

Please carry out an up-to-date cross reference test for the specific vehicle on [www.timingtools.de](http://www.timingtools.de)

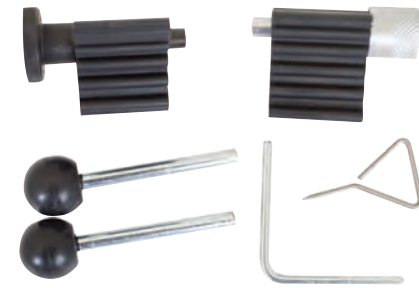
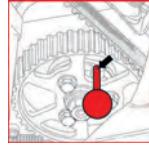

🔧			
400.2700	7 pcs	VAG - Engine Timing Tool Set	455

**consists of:**

🔧			
400.0615	Crankshaft pulley setting tool	190	
400.0901	Tensioning locking pin	4	
400.1415	Crankshaft pulley setting tool	192	
400.1425	Tensioning locking pin	11	
400.9018	Injection pump locking pin Ø 6.0 mm	20	

### VAG Camshaft hub removal tool set

- For the professional engine repair
- Suitable for the simple and correct removal of the cam shaft hub
- Counter hold wrench allows for a precise release or tightening of the cam shaft hub securing screw
- Special steel
- Very high degree of accuracy

**Application range:** Audi, Seat, Škoda and Volkswagen with 1.6 TDi and 2.0 TDi engines

Please carry out an up-to-date cross reference test for the specific vehicle on [www.timingtools.de](http://www.timingtools.de)

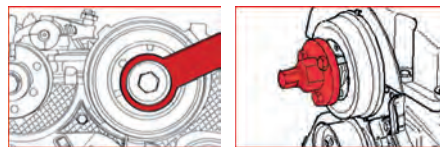

🔧			
400.2110	2 pcs	VAG Camshaft hub removal tool set	760

**consists of:**

🔧			
400.2104	Sprocket holding tool	179	
400.2105	Cam sprocket hub puller	581	

### VAG - Engine Timing Tool Set

- For the professional engine repair
- For locking the crank shaft or cam shaft
- For changing the timing belt
- Very high degree of accuracy

**Application range:** Audi A4, A6, A8 with 2.5 TDi engines, Volkswagen Passat, Sharan with 2.5 TDi engines

Please carry out an up-to-date cross reference test for the specific vehicle on [www.timingtools.de](http://www.timingtools.de)

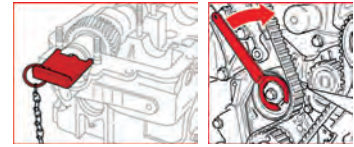

🔧			
400.1550	5 pcs	VAG - Engine Timing Tool Set	560

**consists of:**

X				🔧	
150.3012	2	VAG front mask push back	170		
400.0159	1	Crankshaft timing pin	120		
400.0160	1	Camshaft timing tool (2)	118		

### VAG small tension plate for arresting the automatic pulley

- For the professional engine repair
- Especially designed for fixing the hydraulic timing belt spanner
- Secure hold for changing the timing belt or engine repairs
- Very high degree of accuracy

Please carry out an up-to-date cross reference test for the specific vehicle on [www.timingtools.de](http://www.timingtools.de)

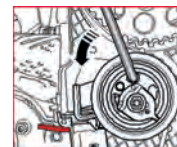

🔧			
400.9019	VAG small tension plate for arresting the automatic pulley	20	

**VAG crank shaft timing belt puller**

- For the professional engine repair
- For damage-free removal of crank shaft timing belt wheels
- Less space requirement through compact method of building
- Suited for work on engines in the vehicle or removed
- Special steel
- Very high degree of accuracy

**Application range:** Audi and Volkswagen with 4 and 5 cylinder engines

Please carry out an up-to-date cross reference test for the specific vehicle on [www.timingtools.de](http://www.timingtools.de)



	Subtable for	Ø mm	Height mm	Weight g
150.3154	VAG	65,0	75,0	440

**VAG Camshaft setting bracket**

- For the professional engine repair
- For locking the cam shafts
- Allows for correct engine adjustment
- With central centring screw
- Removal of the valve cover and seal no longer required
- Very high degree of accuracy

**Application range:** Audi A4, Volkswagen Golf, Bora, New Beetle, Seat Ibiza, Cordoba, Alhambra, Inca, Škoda Octavia with 1.9 SDI or TDI engines (engine code: AHF, ALH, ASY, ASV, AGP, AGR, AQM, AHR, AYQ)

Please carry out an up-to-date cross reference test for the specific vehicle on [www.timingtools.de](http://www.timingtools.de)

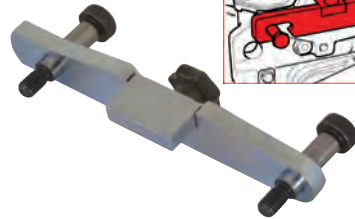
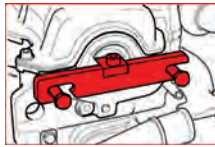

	Subtable for	Weight g
400.9044	VAG Camshaft setting bracket	309

**VAG Crank and camshaft locking tool set**

- For the professional engine repair
- For TDI pump injection engines
- For changing the timing belt
- Secure hold for changing the timing belt or during engine repairs
- Special plastic
- Very high degree of accuracy

**Application range:** Volkswagen Golf, Passat, Lupo / Audi A2 and A3 from 2000 onwards

Please carry out an up-to-date cross reference test for the specific vehicle on [www.timingtools.de](http://www.timingtools.de)

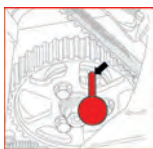

	Subtable for	Weight g
150.3066	2 pcs VAG Crank and camshaft locking tool set	370

**VAG Camshaft locking device**

- For the professional engine repair
- For locking both cam shaft wheels (TDC setting)
- Secure hold thanks to optimal positioning
- Very high degree of accuracy

**Application range:** VAG 1.4 / 1.6 L petrol engines - Volkswagen Lupo, Polo, Golf IV, Bora, Audi A2, Seat, Skoda etc.

Please carry out an up-to-date cross reference test for the specific vehicle on [www.timingtools.de](http://www.timingtools.de)



	Subtable for	Weight g
150.3034	VAG Camshaft locking device	370

**VAG Crank shaft locking device**

- For the professional engine repair
- For locking the oval crank shaft timing belt wheel
- Secure hold thanks to optimal positioning
- Very high degree of accuracy

**Application range:** VAG 4 cylinder diesel / Pump injection engines from 2005 onwards and VAG 2.0 l Common Rail diesel engines

Please carry out an up-to-date cross reference test for the specific vehicle on [www.timingtools.de](http://www.timingtools.de)

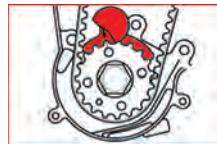

	Subtable for	Weight g
150.3067	VAG Crank shaft locking device	60

**VAG timing chain tensioning wrench**

- For the professional engine repair
- For adjusting the timing chain tension
- For putting on the chain tensioner
- Very high degree of accuracy

**Application:** VAG Group vehicles with 4 valve engines 1.8 and 2.0 TFSI 4 cylinder from the 3rd generation (engine code: CCZA, CCZB, CCZC, CCZD, CDAA, CCAB)

Please carry out an up-to-date cross reference test for the specific vehicle on [www.timingtools.de](http://www.timingtools.de)

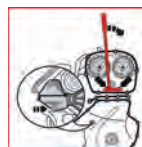

	Subtable for	Weight g
400.4350	VAG timing chain tensioning wrench	562

**VAG Injection pump locking pin**

- For the professional engine repair
- Ideally suited to securing the injection pump
- With air inlet
- Simple handling
- Special steel
- Very high degree of accuracy

**Application range:** Volkswagen Lupo 3L, 1.2/1.4 TDi, Polo 1.4 TDi, Golf / Bora 1.9 SDI / TDi, Passat 1.9 TD (1994-1996), Beetle 1.9 TDi (>1999) and Transporter 1.9TD

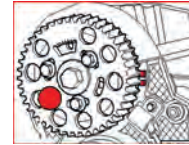

	Subtable for	Ø mm	L mm	Weight g
400.9018	VAG	6,0	80,0	20

**VAG Camshaft adjustment plate**

- For the professional engine repair
- Device for a secure hold to change the timing belt
- For locking the cam shaft
- Secure hold thanks to optimal positioning
- Very high degree of accuracy

**Application:** VAG chain-driven Group vehicles with 2.3 / 2.8 and 2.9 engines, in particular Volkswagen Golf, Bora, Vento, Corrado, Passat, Sharon, Transporter, Seat Toledo

Please carry out an up-to-date cross reference test for the specific vehicle on [www.timingtools.de](http://www.timingtools.de)

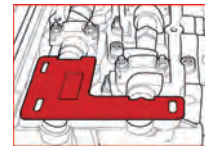

	Subtable for	Weight g
400.9040	VAG Camshaft adjustment plate	57

**VAG 4/3 way cam shaft adjustment tool set**

- For the professional engine repair
- For the installation and removal of the central cam shaft adjustment
- Saves removing the timing chain or removing the engine
- Very high degree of accuracy

**Application range:** VAG Group vehicles 1.8 and 2.0 litre TFSI / TSI engines with timing chains (engine codes: BYT / BZB / CABA / CABB / CABD / CAWB / CBFA / CCTA / CCZA / CCZB / CCZC / CDAA / CDHA / CDHB / CDNB / CDNC / CDND / CFKA / CGYA / CCZA / CCZB / CCZD / CDAA / CDABBYT / BZB / CABA / CABB / CABD / CAWB / CBFA / CCTA / CCZA / CCZB / CCZC / CDAA / CDHA / CDHB / CDNB / CDNC / CDND / CFKA / CGYA / CCZA / CCZB / CCZD / CDAA / CDABBYT)

Please carry out an up-to-date cross reference test for the specific vehicle on [www.timingtools.de](http://www.timingtools.de)

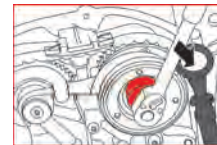

	Subtable for	Weight g
400.9094	2 pcs VAG 4/3 way cam shaft adjustment tool set	63

### VAG automatic pulley wrench for pin-type face

- For tightening and relaxing the timing belt on VAG vehicles
- For pin spacers with driver bores (pin-type face)
- Cranked shape
- With plastic-coated handle

**Application range:** Audi, Volkswagen, Seat, Škoda 4 and 5 cylinder TDI engines, also Volkswagen T4 power steering pumps

Please carry out an up-to-date cross reference test for the specific vehicle on [www.timingtools.de](http://www.timingtools.de)

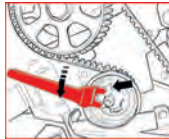

Suitable for		L mm	
400.9008	VAG	140.0	206
400.9009	VAG	210.0	263

### VAG automatic pulley wrench for pin-type face

- For the professional engine repair
- For tightening and relaxing the timing belt on VAG vehicles
- For pin spacers with driver bores (pin-type face)
- Angled shape
- With plastic-coated handle
- Very high degree of accuracy

**Application range:** Audi, Volkswagen, Seat, Škoda 4 and 5 cylinder TDI engines

Please carry out an up-to-date cross reference test for the specific vehicle on [www.timingtools.de](http://www.timingtools.de)

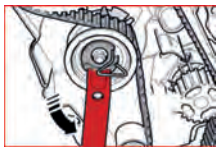

Suitable for		
400.9010	VAG automatic pulley wrench for pin-type face	230

### VAG automatic pulley wrench for pin-type face

- For tightening and relaxing the timing belt on VAG vehicles
- For pin spacers with driver bores (pin-type face)
- 15° angled
- With plastic-coated handle

**Application range:** Audi, Volkswagen, Seat, Škoda 2,0 FS/ TDI engines

Please carry out an up-to-date cross reference test for the specific vehicle on [www.timingtools.de](http://www.timingtools.de)



Suitable for		Pin key mm	Stud Ø mm	
400.9011	VAG	18.0	3.0	259

### VAG Pin wrench 3 mm, adjustable

- Universal usage
- For the actuation of belt tensioners in VAG
- Phosphate
- Special steel

Please carry out an up-to-date cross reference test for the specific vehicle on [www.timingtools.de](http://www.timingtools.de)



Suitable for		Ø mm	L mm	
150.3018	VAG	9,0-45,0	150,0	100

### VAG automatic pulley wrench for pin-type face

- For tightening and relaxing the timing belt on VAG vehicles
- 180° adjustable handle
- For pin spacers with tappet tolerances
- Normal and extra flat ideal for hard to access areas
- With plastic coated handle

**Application range:** VAG 4 and 5 cylinder TDI-Model, T4 Servo pump

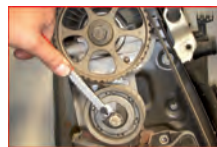

Suitable for		L mm	Stud Ø mm	Pin key mm	
500.4315	VAG	180.0	3.0	18.0	95
150.3017	VAG	185.0	3.0	18.0	105

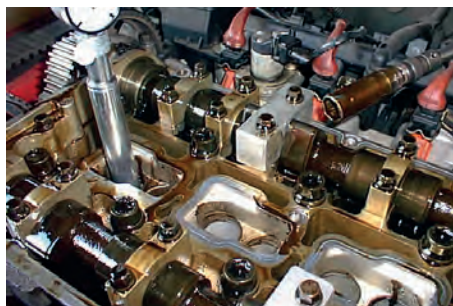

### VAG automatic pulley wrench set for 2.0 RDI PD engines

- Suitable for the assembly and disassembly of the timing belt
- For hard-to-reach places due to the modified support frame screws
- Chrome vanadium

**Application range:** Audi A3 2.0 TDI PD DPHC (05-08) with the engine ID codes AZU, BKD, BHN, BUY and Volkswagen Caddy, Caddy Maxi 2.0 SDI (09-) with BDU, BST with engines with hydraulic spanners and Transporter 1.9 TDI Pd (06-09)

Please carry out an up-to-date cross reference test for the specific vehicle on [www.timingtools.de](http://www.timingtools.de)



Suitable for		
400.2150	3 pcs VAG automatic pulley wrench set for 2.0 RDI PD engines	160

consists of:

Suitable for		
400.2151	Tensioner adjuster Ø 6.0 mm	20
400.2152	Tensioner adjuster Ø 3.9 mm	70
400.2153	Tensioner adjuster Ø 2.5 mm	70

### VAG front mask stub rod

- For moving the front mask (radiator support) forward in order to carry out service work
- Allows for timing belt changes or the renewal of the water pump
- Removes the need for the adjustment of the bonnet lock and the gap measurements

Please carry out an up-to-date cross reference test for the specific vehicle on [www.timingtools.de](http://www.timingtools.de)



Suitable for		
150.3012	VAG	170

### VAG front mask guiding rods

- For moving the front mask (radiator support) forward in order to carry out service work
- Allows for timing belt changes or the renewal of the water pump
- Removes the need for the adjustment of the bonnet lock and the gap measurements

Please carry out an up-to-date cross reference test for the specific vehicle on [www.timingtools.de](http://www.timingtools.de)

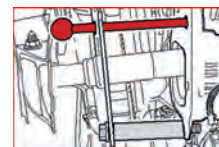

Suitable for		
400.2077	VAG	80
400.2078	VAG	120

VAG front mask guiding and stub rods set

- For moving the front mask (radiator support) forward in order to carry out service work
- Allows for timing belt changes or the renewal of the water pump
- Removes the need for the adjustment of the bonnet lock and the gap measurements

Please carry out an up-to-date cross reference test for the specific vehicle on [www.timingtools.de](http://www.timingtools.de)

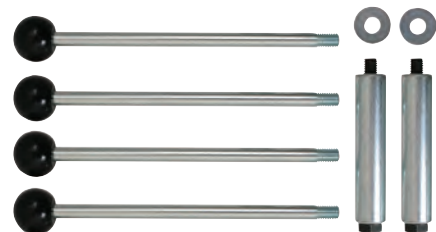

400.2075	6 pcs	VAG front mask guiding and stub rods set	749		

consists of:

X			
150.3012	2	VAG front mask push back	170
400.2077	1	Front mask removal aid (2)	80
400.2078	1	VAG front mask removal aid (2)	120



VAG V belt and timing belt wrench

- For loosening the automatic clamping device
- Problem free changing of the belt
- For hard to reach places
- With plastic-coated handle
- Chrome vanadium

**Application range:** Audi, Seat, Škoda and Volkswagen with 2.0 TDI and 1.4 TSI engines  
**Volkswagen** Beetle (2011-2013), Eos (2007-2013), Golf (2003-2008), Golf (>2008), Golf Estate (2007-2009), Golf Estate (>2009), Gold Plus (2005-2009), Golf Plus (>2009), Golf VI Cabrio (>2011), Jetta (2005-2011), Jetta (>2011), Scirocco (>2008); Passat (2005-2011), Passat (>2011), Tiguan (2010-2013), Polo (>2009), Touran (2007-2013), **Audi** A1 (2010-2013), **Škoda** Octavia (>2004), Yeti (2010-2013), engine code: CAVD, CAXA, CAVB, CAVC



Suitable for		Length mm	
400.4300	VAG	16	380.0

VAG Engine support socket set, extra short

- 12-point
- For the assembly and removal of the aluminium engine support (hard to reach sites)
- Ideal for timing belt change
- Internal square drive to DIN 3120 / ISO 1174 with ball reception
- Extra-short design
- For manual operation
- Matt finish
- Chrome vanadium

**Application range:** For timing belt change on Volkswagen Golf IV, Audi, Škoda, Seat etc.



911.1295	2 pcs	VAG Engine support socket set, extra short	110		

consists of:

911.1293	12 point socket, 16.0 mm short	40			
911.1294	12 point socket, 16.0 mm long	67			

Hexagon socket, long for pulley wheel

- Suited for the assembly and disassembly of the pulley wheel vibration damper, e.g. when changing the timing belt
- 6-point
- FlankTraction-Profile
- In accordance with DIN 3124 / ISO 2725
- Internal square to DIN 3120 / ISO 1174 with ball reception
- Long design
- For manual operation
- Matt finish
- Chrome vanadium

**Application range:** Audi, Seat, Škoda and Volkswagen

Please carry out an up-to-date cross reference test for the specific vehicle on [www.timingtools.de](http://www.timingtools.de)



	mm	D1 mm	D2 mm	L mm	T mm	
917.1254	27.0	34.0	36.0	76.0	19.0	280



Bit socket for spline (XZN®) screws, long

- Ideal for releasing and tightening of the securing screws of the high-pressure pumps, timing belt wheels, e.g. when changing timing belt
- Spline (XZN®)
- Internal square drive to DIN 3120 / ISO 1174 with ball reception
- Long design
- With press fitted nickel plated insert bit
- For manual operation
- Matt finish
- Chrome vanadium

**Application range:** Audi, Seat, Škoda and Volkswagen with TDI Common Rail engines, engine code: CAAA, CAAB, CAAC, CAYB, CBAA, CBAB, CBBB etc.

Please carry out an up-to-date cross reference test for the specific vehicle on [www.timingtools.de](http://www.timingtools.de)



		D mm	L mm	T mm	
911.1353	M10	22.0	110.0	72.0	112

VAG Bit socket for hexagon screws, extra long

- Hexagon socket with ball head
- For releasing and tightening the TDC sensor
- Internal square drive to DIN 3120 / ISO 1174 with ball reception
- Extra-long design
- For manual operation
- Matt finish
- Chrome vanadium

**Application range:** VAG models from 2005, 4-cylinder 2.0l diesel engines



		mm	D mm	L mm	
911.1598		4,0	11,0	300,0	80

Impact bit socket for spline (XZN®) screws, long

- Ideally suited to releasing and tightening the securing screws on the cam shaft wheel
- Spline (XZN®)
- Internal square in accordance with DIN 3121 / ISO 1174
- Long design
- For machinery usage
- Phosphate
- Chrome molybdenum

**Application range:** Volkswagen Transporter >2004 with 2.5 TDI engines and Touareg >2003 with 2.5 TDI engines, engine code: AXD, BNZ, BAC and BPE

Please carry out an up-to-date cross reference test for the specific vehicle on [www.timingtools.de](http://www.timingtools.de)



		L mm	D mm	T mm	
911.0953	M16	75.0	25.0	45.0	150

**VOLVO**

**GM / Opel / Saab - Engine Timing Tool Set**

- For the professional engine repair
- For locking the cam shaft
- For changing the timing belt or the chain
- Very high degree of accuracy
- In durable steel storage case

**Application range:** Opel Astra-G (1998-2006), Vectra-B, Vectra-C (1997 - 2005), Signum (2003-2005), Omega-B (1998-2003), Zafira-A (1999-2005), Sintra (1998-1999), Frontera-B (1998-2004) with 2.0 / 2.2 DTi engines (engine code: Z20DTH / Z20DTL / Z22DTH / Z22DTR) and Saab 9-3 (1998-2004) with 2.2 TID, 9-5 (2002-2007) with 2.2 TID engines (engine code: D223L)

Please carry out an up-to-date cross reference test for the specific vehicle on [www.timingtools.de](http://www.timingtools.de)

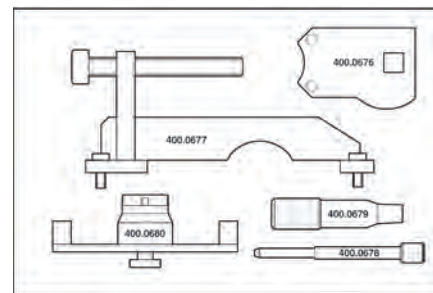
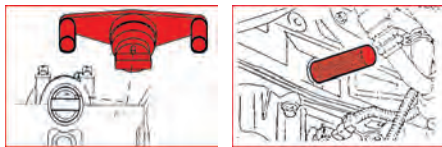

400.0675	5 pcs	GM / Opel / Saab - Engine Timing Tool Set	1.36
----------	-------	---	------

consists of:

400.0676	Camshaft turning tool	7
400.0677	Bracket for timing adjustment wrench	111
400.0678	Injection pump locking pin	41
400.0679	Flywheel TDC locking pin	160
400.0680	Camshaft locking tool	322

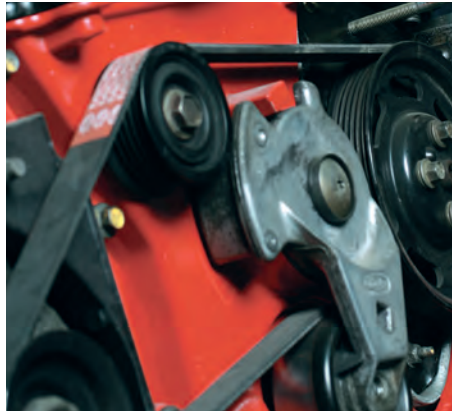

**Volvo - Engine Timing Tool Set**

- For the professional engine repair
- For changing the timing belt
- Very high degree of accuracy
- In durable steel storage case

**Application range:** Volvo C30, S40, V50, S60, S70, S80, V70

Please carry out an up-to-date cross reference test for the specific vehicle on [www.timingtools.de](http://www.timingtools.de)

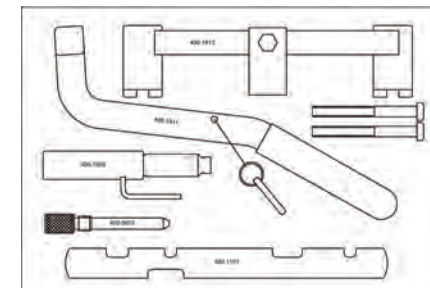
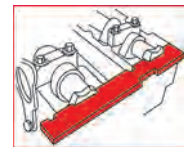

400.1825	7 pcs	Volvo - Engine Timing Tool Set	1.28
----------	-------	--------------------------------	------

consists of:

400.0603	Crankshaft timing pin	51
400.1101	Camshaft setting strap	140
400.1808	Flywheel locking pin	225
400.1811	Tensioner adjuster	239
400.1812	Camshaft locking tool (3)	498

**Volvo - Engine Timing Tool Set**

- For the professional engine repair
- For locking the crank shaft or cam shaft
- Very high degree of accuracy
- In durable steel storage case

**Application range:** Volvo C70 (>2006), S40 (>2004), S60 (>2005), S80 (>2006), V50 (>2004), V60 (>2010), V70 (>2008), V70 XC (>2001), XC60 (>2008), XC70 (>2008), XC90 (>2002), C30 (>2006) (engine code: D5204T2 / D5204T3 / D5204T5 / D5244T / D5244T10 / D5244T11 / D5244T13 / T5244T14 / D5244T15 / D5244T16 / D5244T17 / D5244T18 / D5244T19 / D5244T2 / D5244T3 / D5244T4 / D5244T5 / D5244T6 / D5244T7 / D5244T8 / D5244T9 / D5204T / D4164T / D4162T / D4164T2 / D4192T3 / D4192T4 / D4204T / D4204T2 / D4164T)

Please carry out an up-to-date cross reference test for the specific vehicle on [www.timingtools.de](http://www.timingtools.de)

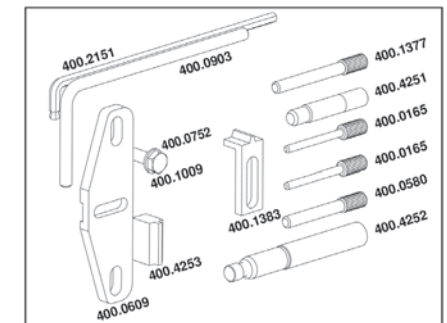
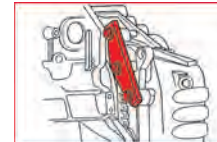

400.4250	14 pcs	Volvo - Engine Timing Tool Set	1.14
----------	--------	--------------------------------	------

consists of:

400.0165	Camshaft locking pin 5.0 mm	19
400.0580	Crankshaft locking pin Ø 8.0 mm	30
400.0609	Flywheel locking tool	308
400.0752	Washers M8 (2)	1
400.0903	Crankshaft locking pin	85
400.1009	Locking screw M8 x 20.0 mm	11
400.1377	Tensioning locking pin	35
400.1383	Flywheel locking tool	30
400.2151	Tensioner adjuster Ø 6.0 mm	20
400.4251	Crankshaft locking pin	102
400.4252	Cam shaft locking pin	160
400.4253	Flywheel locking tool	10

**Volvo - Engine Timing Tool Set**

- For the professional engine repair
- For locking the crank shaft
- Very high degree of accuracy
- In durable steel storage case

**Application range:** Volvo C70 (>2006), S40 (>2004), S60 (>2005), S80 (>2006), V50 (>2004), V60 (>2010), V70 (>2008), V70 XC (>2001), XC60 (>2008), XC70 (>2008), XC90 (>2002), C30 (>2006) with 2.0 GTDi engines (engine code: D5204T2 / D5204T3 / D5204T5 / D5244T / D5244T10 / D5244T11 / D5244T13 / D5244T14 / D5244T15 / D5244T16 / D5244T17 / D5244T18 / D5244T19 / D5244T2 / D5244T3 / D5244T4 / D5244T5 / D5244T6 / D5244T7 / D5244T8 / D5244T9 / D5204T / D4164T / D4162T / D4164T2 / D4192T3 / D4192T4 / D4204T / D4204T2 / D4164T)

Please carry out an up-to-date cross reference test for the specific vehicle on [www.timingtools.de](http://www.timingtools.de)

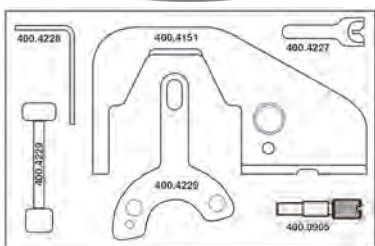

400.4225	8 pcs	Volvo - Engine Timing Tool Set	1.14
----------	-------	--------------------------------	------

**consists of:**

400.0905	Crankshaft locking pin	33
400.4151	Cam shaft alignment plate	700
400.4227	Crank shaft sensor alignment tool	30
400.4228	Tension pin 3.0 mm	10
400.4229	Crank shaft pulley wheel adjustment tool (2)	290

**Ford / Volvo - Engine Timing Tool Set**

- For the professional engine repair
- For locking the crank shaft and cam shaft
- For changing the timing belt
- Very high degree of accuracy

**Application range:** Ford B-Max (2012), C-Max (2010), Focus (2011), Galaxy (2010), Grand-C-Max (2010-2011), Mondeo (2010), S-Max (2010), Volvo S60 (2001), S80 (2010-2011), V60 (2011), V70 (2010-2011) with 1.6 Ti-VCT, 2.0 TDCI engines (engine code: IQJA / JQDA / JQDB / JQDA / JTDB / JQDA / JQDB / JTWA / JTWB / JQDA / JTDA / JTDB / JTBA / JTBB / B4164T3 / B4164T / B4164T2)

Please carry out an up-to-date cross reference test for the specific vehicle on [www.timingtools.de](http://www.timingtools.de)



400.4125	4 pcs	Ford / Volvo - Engine Timing Tool Set	498
----------	-------	---------------------------------------	-----

**consists of:**

400.0902	Camshaft locking tool	384
400.0905	Crankshaft locking pin	33
400.4126	Crank shaft discs adjustment tool	50
400.4127	Pin for chain tensioner	10

**Ford / Land Rover / PSA / Volvo - Engine Timing Tool Set**

- For the professional engine repair
- For changing the timing belt
- Very high degree of accuracy

**Application range:** Ford, Land Rover, PSA, Volvo vehicles with 2,0 / 2,2 DOHC Common-Rail Diesel engines

Please carry out an up-to-date cross reference test for the specific vehicle on [www.timingtools.de](http://www.timingtools.de)

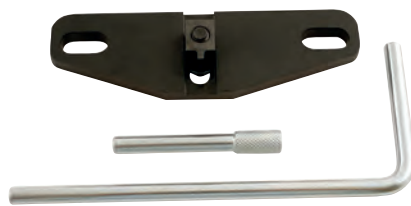
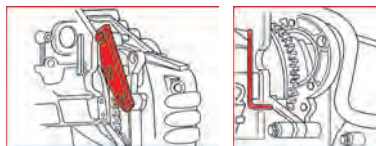

400.1625	3 pcs	Ford / Land Rover / PSA / Volvo - Engine Timing Tool Set	473
----------	-------	--	-----

**consists of:**

400.0580	Crankshaft locking pin Ø 8,0 mm	30
400.0609	Flywheel locking tool	308
400.0903	Crankshaft locking pin	85

**Ford / Volvo - Engine Timing Tool Set**

- For the professional engine repair
- For locking the crank shaft or cam shaft
- For changing the timing belt
- Very high degree of accuracy

**Application range:** Ford, Volvo with petrol engines

Please carry out an up-to-date cross reference test for the specific vehicle on [www.timingtools.de](http://www.timingtools.de)

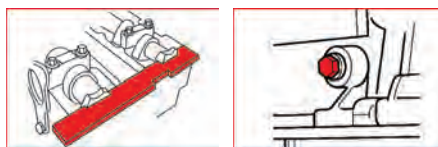

400.1525	4 pcs	Ford / Volvo - Engine Timing Tool Set	291
----------	-------	---------------------------------------	-----

**consists of:**

400.0155	Crankshaft timing pin	240
400.0603	Crankshaft timing pin	51
400.0905	Crankshaft locking pin	33
400.1101	Camshaft setting strap	140

**UNIVERSAL**

**Universal - Engine Timing Tool Set for diesel engines**

- For the professional engine repair
- Special set for adjusting and locking diesel engines
- Very high degree of accuracy
- In durable steel storage case

**Application range:** Audi, Citroën, Ford, Opel, Peugeot, Renault, Rover, Volvo, Volkswagen vehicles with diesel engines

Please carry out an up-to-date cross reference test for the specific vehicle on [www.timingtools.de](http://www.timingtools.de)

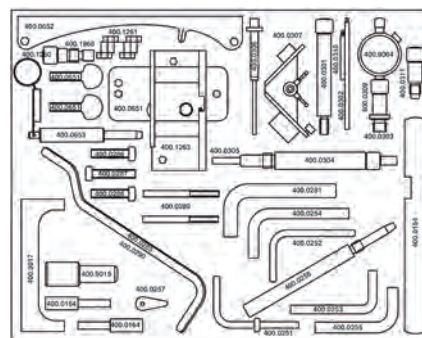
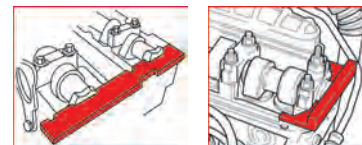

400.1950	40 pcs	Universal - Engine Timing Tool Set for diesel engines	4.74
----------	--------	---	------

**consists of:**

400.0154	Camshaft setting strap	150
400.0164	Timing pin Ø 6,6 mm (2)	74
400.0251	Injection pump locking pin Ø 6.0 mm	30
400.0252	Camshaft locking pin 6.0 mm	26
400.0253	Locking pin Ø 8.0 mm	41
400.0254	Locking pin Ø 9.5 mm	60
400.0255	Locking pin Ø 10.0 mm	60
400.0257	Crankshaft TDC locking pin	124
400.0258	Shim tool (2)	3
400.0281	Timing pin Ø 12,7 mm	569
400.0285	Crankshaft locking pin Ø 8,0 mm	97
400.0286	Screw M8 x 35 mm (2)	16
400.0287	Screw M8 x 40,0 mm	18
400.0289	Injector pump locking pin (2)	14
400.0290	Crankshaft setting pin Ø 6,0 mm	55
400.0301	Dial gauge adapter M8 (Bosch), long	71
400.0302	Dial gauge extension, long 99 mm	9
400.0303	Converter M8 x M12	12
400.0304	TDC determining pin / dial indicator bracket M14 x 2,0 mm	135

consists of:

		9
400.0305	Extension	460
400.0306	Dial gauge probe for Lukas-CAV-Roto	17
400.0307	Dial gauge assy for Lukas-CAV-Roto	125
400.0309	Dial gauge adapter M8 (Bosch) short, silver	37
400.0310	Dial gauge extension short	4
400.0311	Dial gauge adapter M10 (Bosch) short, black	40
400.0651	Camshaft locking tool (3)	169
400.0652	Flywheel TDC indicator	80
400.0653	Flywheel locking pin	79
400.1260	Camshaft locking tool (5)	9
400.1261	Locking screw M6 x 10.0 mm	4
400.1263	Mounting bracket assy	330
400.1968	Special tip	16
400.9004	Precision-dial indicator gauge 0 - 10 mm	78
400.9015	Injection pump locking pin Ø 15.4 mm	126
400.9017	Camshaft setting strap	120

### Universal - Engine Timing Tool Set

- For the professional engine repair
- For locking the crank shaft or cam shaft
- For changing the timing belt
- Also for locking twin-cam, dual cam shaft
- Very high degree of accuracy
- In durable steel storage case

**Application range:** universal usage on many vehicles, in particular **Audi, Citroën, Ford, Honda, Land Rover, Mazda, MG, Peugeot, Rover, Opel** with petrol and diesel engines with single or twin cams

Please carry out an up-to-date cross reference test for the specific vehicle on [www.timingtools.de](http://www.timingtools.de)

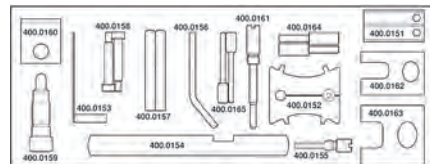
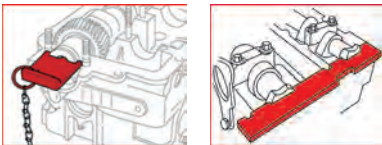

		9
400.0150	19 pcs Universal - Engine Timing Tool Set	1.38

consists of:

X		9
400.0151	1 Camshaft locking tool	125
400.0152	1 Camshaft locking tool	150
400.0153	1 Tensioner adjuster, square 8.0 mm	6
400.0154	1 Camshaft setting strap	150
400.0155	1 Crankshaft timing pin	240
400.0156	1 Crankshaft timing pin Ø 6.0 mm	23
400.0157	1 Crankshaft locking pin Ø 6.0 mm, short (2)	101
400.0158	1 Crankshaft locking pin (2)	30
400.0159	1 Crankshaft timing pin	120
400.0160	1 Camshaft timing tool (2)	118
400.0161	1 Crankshaft TDC locking pin	75
400.0162	1 Opel / Saab Camshaft locking tool	186
400.0163	1 Camshaft locking tool	143
400.0164	1 Timing pin Ø 6.6 mm (2)	74
400.0165	2 Camshaft locking pin 5.0 mm	19

### Universal - Engine Timing Tool Set

- For the professional engine repair
- For locking the crank shaft or cam shaft
- For changing the timing belt
- Also for servicing the injector pump
- Very high degree of accuracy
- In durable steel storage case

**Application range:** universal usage on many **Audi, Citroën, Ford, Peugeot, Renault, Rover, Volvo, Volkswagen** vehicles

Please carry out an up-to-date cross reference test for the specific vehicle on [www.timingtools.de](http://www.timingtools.de)

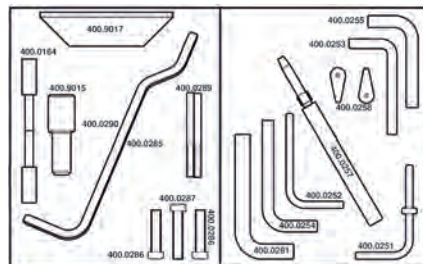

		9
400.0275	19 pcs Universal - Engine Timing Tool Set	1.84

consists of:

		9
400.0164	Timing pin Ø 6.6 mm (2)	74
400.0251	Injection pump locking pin Ø 6.0 mm	30
400.0252	Camshaft locking pin 6.0 mm	26
400.0253	Locking pin Ø 8.0 mm	41
400.0254	Locking pin Ø 9.5 mm	60
400.0255	Locking pin Ø 10.0 mm	60
400.0257	Crankshaft TDC locking pin	124
400.0258	Shim tool (2)	3
400.0261	Timing pin Ø 12.7 mm	569
400.0285	Crankshaft locking pin Ø 8.0 mm	97
400.0286	Screw M8 x 35 mm (2)	16
400.0287	Screw M8 x 40.0 mm	18
400.0289	Injector pump locking pin (2)	14
400.0290	Crankshaft setting pin Ø 6.0 mm	55
400.9015	Injection pump locking pin Ø 15.4 mm	126
400.9017	Camshaft setting strap	120

### Diesel fuel pump timing set

- For the professional engine repair
- Precise measuring device for the upper entry hole
- For resetting the injection time on diesel engines
- Very high degree of accuracy
- In durable steel storage case

**Application range:** Alfa Romeo, Audi, BMW, Daihatsu, Fiat, Ford, Isuzu, Iveco, Lancia, Land Rover, Mazda, Mitsubishi, Nissan, PSA (XUD), Renault, Rover, Volkswagen vehicles with Bosch, EP/VE Rotary, Niki, Nippon Denso, CAV RotoDiesel, Top injection fuel pumps

Please carry out an up-to-date cross reference test for the specific vehicle on [www.timingtools.de](http://www.timingtools.de)

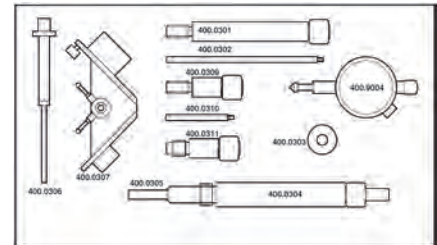

		9
400.0300	11 pcs Diesel fuel pump timing set	710

consists of:

		9
400.0301	Dial gauge adapter M8 (Bosch), long	71
400.0302	Dial gauge extension, long 99 mm	9
400.0303	Converter M8 x M12	12
400.0304	TDC determining pin / dial indicator bracket M14 x 2.0 mm	135
400.0305	Extension	460
400.0306	Dial gauge probe for Lukas-CAV-Roto	17
400.0307	Dial gauge assy for Lukas-CAV-Roto	125
400.0309	Dial gauge adapter M8 (Bosch) short, silver	37
400.0310	Dial gauge extension short	4
400.0311	Dial gauge adapter M10 (Bosch) short, black	40
400.9004	Precision-dial indicator gauge 0 - 10 mm	78

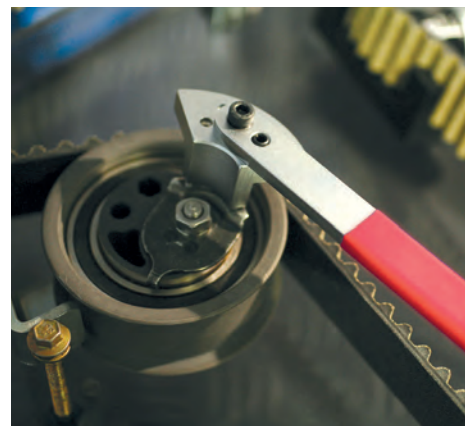



**Diesel fuel pump timing set**

- For the professional engine repair
- Precise measuring device
- Very high degree of accuracy
- In durable steel storage case

**Application range:** Alfa Romeo, Audi, BMW, Daihatsu, Fiat, Ford, Isuzu, Iveco, Lancia, Land Rover, Mazda, Mitsubishi, Nissan, Renault, Rover and Volkswagen vehicles with Bosch, Kikkī, Nippon Denso injection pumps with threads of M8, M10 and M12, with new M10 Adapter in particular for Ford Transit

Please carry out an up-to-date cross reference test for the specific vehicle on [www.timingtools.de](http://www.timingtools.de)

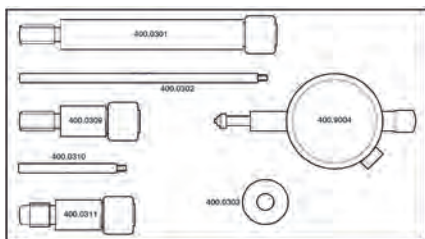
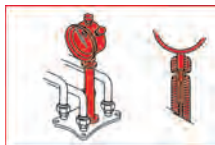

			🔑
400.0325	7 pcs	Diesel fuel pump timing set	301

consists of:

			🔑
400.0301	Dial gauge adapter M8 (Bosch), long	71	
400.0302	Dial gauge extension, long 99 mm	9	
400.0303	Converter M8 x M12	12	
400.9004	Precision-dial indicator gauge 0 - 10 mm	78	
400.0309	Dial gauge adapter M8 (Bosch) short, silver	37	
400.0310	Dial gauge extension short	4	
400.0311	Dial gauge adapter M10 (Bosch) short, black	40	



**TDC finder set**

- For quickly establishing the TDC point
- Suitable for both petrol and diesel engines
- Is used e.g. when changing the timing belt or when disassembling the cylinder head (seal change)
- Display unit with measuring tube, piston and magnet bracket
- Connection hose with ignition or glow plug thread adapters and universal cone adaptor
- Aluminium lengthener for deep ignition chambers
- In durable plastic storage case

Please carry out an up-to-date cross reference test for the specific vehicle on [www.timingtools.de](http://www.timingtools.de)



			🔑
152.2055	11 pcs	TDC finder set	180

consists of:

			🔑
152.2056	Hose	31	
152.2057	Hooks with magnet	5	
152.2058	Measuring pipe	13	
152.2059	Lengthener with connection pipe and cone adaptor	26	
152.2062	Adapter set, 5 pcs, Ø 8-10-12-14-18 mm	13	

**TDC determining pin / dial indicator bracket M14 x 1.25**

- For the professional engine repair
- For adjusting the crank shaft to the top dead centre (TDC) point
- Used in place of spark plugs
- To be used alongside dial indicator 400.9004
- Special steel
- Very high degree of accuracy

Please carry out an up-to-date cross reference test for the specific vehicle on [www.timingtools.de](http://www.timingtools.de)



	mm	Ø mm	Length mm	🔑
400.9026	M14 x 1,25	2,0	262,0	288

**TDC determining pin / dial indicator bracket M14 x 1.25**

- For the professional engine repair
- For adjusting the crank shaft to the top dead centre (TDC) point
- Used in place of spark plugs
- To be used alongside dial indicator 400.9004
- Special steel
- Very high degree of accuracy

Please carry out an up-to-date cross reference test for the specific vehicle on [www.timingtools.de](http://www.timingtools.de)



	mm	Ø mm	Length mm	🔑
400.9027	M14 x 1,25	5,0	262,0	288

**TDC determining pin M14 x 1.25**

- For the professional engine repair
- For adjusting the crank shaft to the top dead centre (TDC) point
- Used in place of spark plugs
- Grooves indicate when the piston is at the TDC point
- Special steel
- Very high degree of accuracy

Please carry out an up-to-date cross reference test for the specific vehicle on [www.timingtools.de](http://www.timingtools.de)



	mm	Ø mm	Length mm	🔑
400.9006	M14 x 1,25	2,0	262,0	288

**TDC determining pin / dial indicator bracket M14 x 2.0**

- For adjusting the crank shaft to the top dead centre (TDC) point
- Used in place of spark plugs
- To be used alongside dial indicator 400.9004
- Special steel

Please carry out an up-to-date cross reference test for the specific vehicle on [www.timingtools.de](http://www.timingtools.de)



	mm	Ø mm	Length mm	🔑
400.0304	M14 x 2,0	16,0	130,0	135

**Precision-dial indicator gauge 0 - 10 mm**

- For the professional engine repair
- In accordance with DIN 878
- With securing screw and turnable dial face
- Shockproof
- Splashproof
- For use alongside with TDC determining pins
- For adjusting the crank shaft to the top dead centre (TDC) point
- Measuring bolt and tensioning shaft made from rust-proof steel
- Very high degree of accuracy

Please carry out an up-to-date cross reference test for the specific vehicle on [www.timingtools.de](http://www.timingtools.de)



	Measuring range mm	Display accuracy mm	Pointer revolution mm	🔑
400.9004	0 - 10	+/- 0,01	1,0	78

### Universal - Engine Timing Tool Set

- For the professional engine repair
- Ideal range of common locking tools
- For locking the fly wheels
- For locking of the crank shaft
- For locking the cam shaft
- Secure hold thanks to optimal positioning
- Aluminium
- Very high degree of accuracy

**Application range:** Audi, Citroën, Peugeot, Fiat, Isuzu, Peugeot, Rover, Saab, Seat, Škoda, Opel, Volkswagen vehicles

Please carry out an up-to-date cross reference test for the specific vehicle on [www.timingtools.de](http://www.timingtools.de)

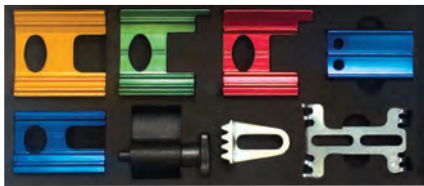

Anwendung für			
400.2650	9 pcs	Universal - Engine Timing Tool Set	1.46

consists of:

Anwendung für		
400.0103	Opel Camshaft locking tool (right)	119
400.0104	Camshaft locking tool left	120
400.0151	Camshaft locking tool	125
400.0162	Opel / Saab Camshaft locking tool	186
400.0163	Camshaft locking tool	143
400.0436	Flywheel locking tool	135
400.0615	Crankshaft pulley setting tool	190
400.1254	Flywheel locking tool	23

### Camshaft locking tool

- For the professional engine repair
- Clamping device for a secure hold to change the timing belt
- Special plastic
- Very high degree of accuracy

Please carry out an up-to-date cross reference test for the specific vehicle on [www.timingtools.de](http://www.timingtools.de)



Anwendung für			
150.3059	1 pcs	Opel Ecotec 1,4 - 1,6 -16V after 1993 - Corsa B - Tigra - Astra F - Vectra	30
150.3061	1 pcs	Opel Ecotec 1,8 - 2,0 - 2,2 - 16V after 1995 - Astra - Frontera - Sintra - Omega - Vectra	30
150.3062	1 pcs	Opel with small camshaft wheels 1,8 - 2,0 - 16V after 1993 - Astra - Calibra - Omega 1,4 - 1,6	30
150.3063	1 pcs	Opel Right hand drive 2,5i - 2,0i - 16V ab 1994 / Vectra - Omega, Saab 900 - 9000	30
150.3064	1 pcs	Opel left hand drive 2,5i - 3,0i - 16V after 1994 / Vectra - Omega, Saab 900 - 9000	30
150.3068	2 pcs	Opel Engine Z16XEP and Z18XER Astra, Zafira, Vectra	60
150.3050	1 pcs	Mazda 626 after 1992/ 323 after 1998, Premacy after 1999	50
150.3056	1 pcs	Kia Carnival Diesel after 1998	80
150.3055	1 pcs	Kia Clarus 1,6 - 1,8 after 1997	40
150.3058	1 pcs	Hyundai Sontana after 1999	30
150.3060	1 pcs	Rover 214 after 1995 - 216 after 1995 - 414 after 1990 - 416 after 1995 - MGF after 1995 / 75 1.8 after 1999 / 45 1.8 - 1.6 after 2000 / 25 after 2000	20
150.3051	1 pcs	Mitsubishi Space Wagon after 1997	30
150.3053	2 pcs	Mitsubishi 24V Galant 2,5 after 1997 - 24V Sigma 3,0 after 1991 - Galant 4x4 after 1991	60
150.3054	2 pcs	Mitsubishi Pajero 3500 after 1998	70
150.3052	2 pcs	Mitsubishi Carisma after 1996 1997 - Space Star after 1997 - Galant 2,0GTI after 1991	60

### Universal twin Camshaft Sprocket Locking Tool

- For the professional engine repair
- For locking cam shafts that are next to each other
- Universal usage for engines with 1, 2 or 4 cam shafts
- Also suitable for chain wheels with flanges
- Enables cam belt change with mounted locking tool
- Ideal for locking of diesel injection pump wheels
- The distance of the timing wheels to each other make no difference
- Also usable in gear cam wheels with different tooth form
- Prevents the timing belt being altered
- Universal tooth profile fits on all current camshafts
- Special metal
- Very high degree of accuracy
- In durable plastic storage case

Please carry out an up-to-date cross reference test for the specific vehicle on [www.timingtools.de](http://www.timingtools.de)



Anwendung für			
150.3190	5 pcs	Universal twin Camshaft Sprocket Locking Tool	1.20

consists of:

Anwendung für		
150.3171	Cam shaft locking tool	110
150.3172	Long bridges	70
150.3196	Cornet screws (2)	40
150.3197	Cam shaft marking device	95

### Universal locking pin and marking pin set

- For the professional engine repair
- Versatile usage
- For sage locking of the tensioning element
- Very high degree of accuracy

**Application range:** Alfa Romeo, Audi, Chrysler, Ford, Honda, Hyundai, Lexus, Mazda, Mitsubishi, Peugeot, Renault, Seat, Škoda, Toyota, Volkswagen, Volvo etc.

Please carry out an up-to-date cross reference test for the specific vehicle on [www.timingtools.de](http://www.timingtools.de)



Anwendung für		
150.3019	Ø mm	20
	0,8 - 1,25 - 1,4 - 1,5 - 1,7 - 1,9	

### Pulley wheel counter hold wrench

- Suitable for counter holding the timing belt wheel on the cam shaft
- Hole distance can be varied
- Adjustable, universal usage
- With plastic-coated handle
- Chrome vanadium

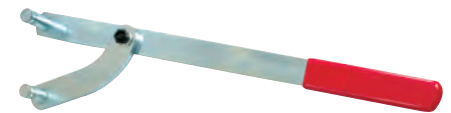
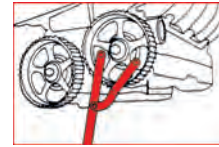

Anwendung für		Length mm	
400.9007	universal	410.0	525

### Universal locking tool / counter tool for crank shaft wheels

- Ideally suited to almost all vehicle types
- For working areas with gear diameters 45 - 190 mm
- With quick adjustment for setting the working area
- Universally used tool for locking, turning and securing locked pulley wheels
- Allows the crank shaft drive wheels to turn or for releasing the securing screws on the pulley wheel
- Ideal leverage thanks to 390 mm total length
- Very narrow tool for maximum access
- Quick and easy usage
- Maximum holding force
- With plastic-coated handle
- Special steel



Anwendung für		Length mm	
150.2990	Ø mm	45-190	390.0
	L mm		500

**Universal timing gear holder set**

- Ideally suited for almost all vehicle types
- Universal usable tool for locking, turning and fastening for stepped timing belts
- The overall length of 520 mm guarantees an optimal lever for loosening the timing belts reinforcement screws
- Stepless adjustment of Ø 40 - 220 mm - pin height: 35 mm
- Includes 4 pairs of screw on plugs
- With plastic coated handle
- Special steel

**Application range:** Timing belt wheels on camshafts and Injection pumps bleeding of wheels and couplings etc.

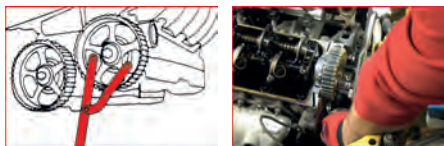

150.3000	11 pcs	Universal timing gear holder set	2.20

consists of:

150.3001	Adjustable lever f.150.3000, 520mm	1120	
150.3002	Locking pin f.150.3000, 2pcs, 6-10mm	100	
150.3003	Locking pin f.150.3000, 2pcs, 8-11mm	50	
150.3004	Locking pin f.150.3000, 2pcs, 10-12mm	40	
150.3005	Locking pin f.150.3000, 2pcs, 11-16mm	40	
150.3006	Knurled nut f.locking pin,150.3000, 2pcs	20	

**Pin-type face wrench set, seamlessly adjustable with interchangeable pins**

- Universal application for common two-hole nuts
- With interchangeable pins
- Each double pin wrench is replacing 4 single key sizes
- Adjustable in diameter
- Phosphate finish
- Special steel
- In durable plastic storage case



150.3205	19 pcs	Pin-type face wrench set, seamlessly adjustable with interchangeable pins	1.56

consists of:

150.3206	Pin-type face wrench, adjustable, length 263 mm	485	
150.3207	Pin-type face wrench, adjustable, length 215 mm	293	
150.3208	Pin-type face wrench, adjustable, length 161 mm	155	
150.3209	Pin-type face wrench, adjustable, length 115 mm	57	
150.3210	Pin pair, Ø 2.37 mm	2	
150.3211	Pin pair, Ø 2.90 mm	2	
150.3212	Pin pair, Ø 4.87 mm	5	
150.3213	Pin pair, Ø 5.91 mm	7	
150.3214	Pin pair, Ø 6.87 mm	13	
150.3215	Pin pair, Ø 7.92 mm	15	
150.3216	Pin pair, Ø 9.87 mm	28	
150.3217	Pin pair, Ø 11.90 mm	37	

**V-belt and tooth belt wrenches**

- 12-point
- For loosening the automatic clamping device
- Problem free changing of the belt
- Saves the cooling unit service on VAG
- For hard to reach places
- With plastic-coated handle
- Chrome vanadium

**Application range:** Audi A4, Volkswagen Passat > 97 with TDI or pump injector engines Opel, DOHC 4- / 6 cylinder (e.g. Astra F with cooling), Saab V6 engines, Mitsubishi



		L mm	
150.1206	10	460.0	320
150.1207	11	460.0	320
150.1208	12	460.0	320
150.1201	13	460.0	320
150.1209	14	460.0	320
150.1202	15	460.0	320
150.1203	16	460.0	320
150.1204	17	460.0	320
150.1213	18	460.0	320
150.1205	19	460.0	320

**Universal V-belt and tooth belt wrenches**

- TX-E-Profile
- For loosening the automatic clamping device
- Problem free changing of the belt
- For hard to reach places
- With plastic-coated handle
- Chrome vanadium



		L mm	
150.1214	E8	460.0	320
150.1216	E10	460.0	320
150.1217	E12	460.0	320
150.1218	E14	460.0	320
150.1219	E16	460.0	320
150.1221	E18	460.0	320
150.1222	E20	460.0	320
150.1223	E22	460.0	320

**BELT TENSION CHECKER**

**Timing belt tensions test instrument**

- For inspection of the timing post tensioning
- For the timing belt on the combustion engine
- With mm scale
- 10N (~1kp corresponds a revolution)
- Special steel

**Application range:** Can be used everywhere there is the technical data for the allowable through bend of the timing belt in mm in a certain power in N or kp revolutions



**Technical data:**

Scale division: in mm  
 Measurement mode: mechanical (spring)  
 Adjusting nut revolution around 360°: 1.0  
 Adjusting nut pitch: 1,0/10,0 mm

	L mm	
150.3015	100.0	0,0-20,0 mm 260

**Electronic timing belt tension tester**

- For testing the tension of toothed belts and V-ribbed belts
- Measurement using the latest method = frequency measurement in Hertz
- With data log, setting values and correct position of the measuring sensor on the belt drive
- One man operation, easy to use
- LED display and acoustic measuring signal
- Automatic shutdown after 120 seconds
- In durable plastic storage case

**Application range:** Maintenance of vehicles, replacement of belts, suitable for passenger cars up to LCV



**Technical data:**

Power requirement: 9V block battery  
 Working range: 30-520 Hz  
 Cable length: 1.2 m

150.3165	8 pcs	Electronic timing belt tension tester	1.11

1  
2  
3  
4  
5  
6  
7  
8  
9  
10  
11  
12  
13  
14  
15  
16  
17  
18  
19  
20  
21  
22  
23  
24  
25  
26